



Datasheet

Membrane Potentiometer

*customized design and
standard stock sizes*

1 product
for many
applications



Features:

- ultraflat (0,5mm) (0,02")
- excellent repeatability
- customized design

Applications:

- industrial
- medical
- automotive
- commercial

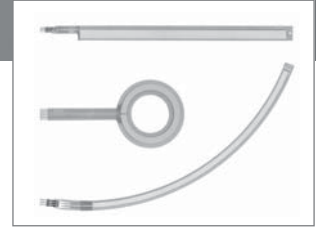

Specifications for rectilinear and rotary standard versions

Electrical Specifications	SoftPot	ShieldedPot <i>(Preliminary data)</i>	HotPot
Resistance, standard	10kΩ (length >300mm 20kΩ)	10kΩ (length >300mm 20kΩ)	10kΩ (>300mm 20kΩ)
Resistance Range, customized	1kΩ to 100kΩ	1kΩ to 100kΩ	5kΩ to 100kΩ
Resistance Tolerance	± 20%		
Effective Electrical Travel	8 to 2400 mm	10 to 1200 mm	10 to 1200 mm
Linearity, independent	± 3% for rectilinear, ± 5% for rotary		
Power Rating (depending on size) (varies with length and temperature)	1 Watt max. @ 25°C	1 Watt @ 25°C	1 Watt @ 25°C
Resolution	Theoretical-Infinite; resolution dependant on contact wiper thickness and construction		
Dielectric Value	No affect @ 500 VAC, 1 minute	No affect @ 500 VAC, 1 minute	No affect @ 500 VAC, 1 minute
Mechanical Specifications			
Live Cycle (depending on wiper)	>1 million	>5 million	>10 million
Height	typ. ≤0,51 mm / 0,020"	typ. ≤0,70 mm / 0,030"	typ. ≤0,51 mm / 0,020"
Actuation Force (Actuation force increase app. 30% for HP, EP) (No affect for SP)	-40°C 0.8 to 1.8 N -25°C 0.8 to 1.8 N +23°C 0.6 to 1.5 N +75°C 0.5 to 1.4 N	2.0 to 4.0 N 2.0 to 4.0 N 0.8 to 2.0 N 0.7 to 1.8 N	3.0 to 5.0 N 2.0 to 5.0 N 0.8 to 2.0 N 0.7 to 1.8 N
Environmental Specifications			
Operating Temperature (with contact actuator)	-40°C to +50°C	-40°C to +75°C	-40°C to +125°C
Humidity	No affect @ 95% RH, 4hrs <50°C		no affect @ 95% RH, 24hrs 60°C
Altitude	10,000 meters		
IP Rating (Pot itself)	66		
Shock	No closures >10msec @ 100g half-sine on four sides	under test	3 orthogonal axis, 20 g. peak, 11 msec pulse, no affect
Vibration	No closure >10msec @ 1 hour random sine test	under test	10 to 55 Hz with 0.03 amplitude, no affect
Connection			
Connections	Solder Tabs (upon on request housing and other connectors)		
Individual options			
customized	Let us know your application, and we will help you design the optimum part		



Drawing (SoftPot, ShieldedPot, Hotpot)

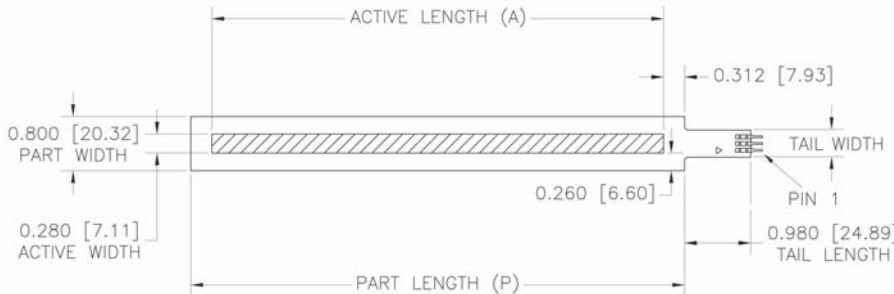

TOLERANCE
UNLESS OTHERWISE SPECIFIED

DIE MAKING	+-.005"
FINISH CUT GRAPHIC	+-.010"
FINISH CUT CIRCUIT	+-.015"
PRINT TO CUT REGS	+-.015"
PRINT TO PRINT REGS	+-.010"
LASER CUT PROTO'S	+-.050"

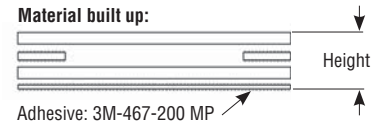

Active length	50,00mm / 1.969"	100,00mm / 3.937"	170,00mm / 6.693"	200,00mm / 7.874"	300,00mm / 11.811"	400,00mm / 15.748"	500,00mm / 19.685"
Part length	65,86mm / 2.593"	115,86mm / 4.562"	185,86mm / 7,32"	215,86mm / 8.499"	315,86mm / 12.436"	415,86mm / 16.373"	515,86mm / 20.310"
Height	≤0,51mm / 0.020" (for SP and HP)			≤0,70 mm / 0,030 (for EP)			
Resistance, standard	10kΩ	10kΩ	10kΩ	10kΩ	10kΩ	20kΩ	20kΩ
Drawing# SoftPot	7182	7183	7282	7184	7185	7284	7186
Drawing# HotPot	7177	7294	7281	7179	7180	7283	7181
Adhesive	3M-467-200 MP						

Connection

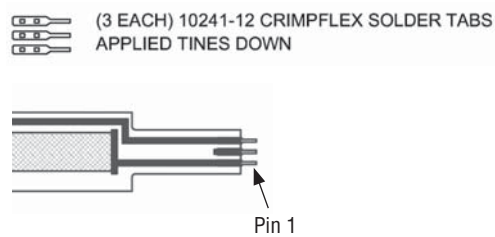
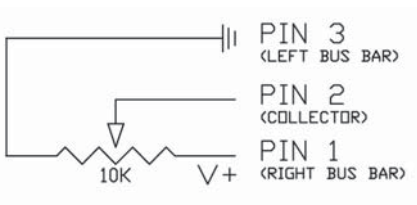

How to Order

Type-	Model-	Active area length-	Resistance-	Connector type-
Example: SP-L-0200-103-ST				
SP = SoftPot HP = HotPot EP = ShieldedPot	L = Rectilinear	0050 = 50 mm 0100 = 100 mm 0170 = 170 mm 0200 = 200 mm 0300 = 300 mm 0400 = 400 mm 0500 = 500 mm	102 = 1 KOhm 502 = 5 KOhm 103 = 10 KOhm 203 = 20 KOhm	ST = Solder tabs MP = Male Pins RF = Receptacles Female RH = Receptacles Housing ⁽¹⁾

Bold marked partnumbers are preferred parts, all other parts will be produced after order and may have price adders.

⁽¹⁾ We recommend Nicomatic Housing. Details must be specified.



Decades of experience

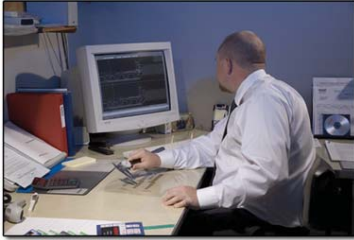

Potentiometer and Membrane Switch designs demand custom treatment, as each design is unique. Our corps of design engineers have combined decades of experience in the industry with the tools and the technology to make your product with the highest quality.



Clean Room



Tests To Your Needs



Custom Production



Major Suppliers:
3M, Dupont, GE

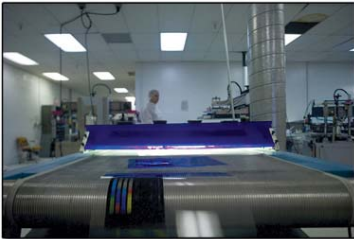

UV Curing Unit



Quality Team Meetings



Process Involves Multiple Steps



Our Core-Competency





Drawing (SoftPot, ShieldedPot, HotPot)

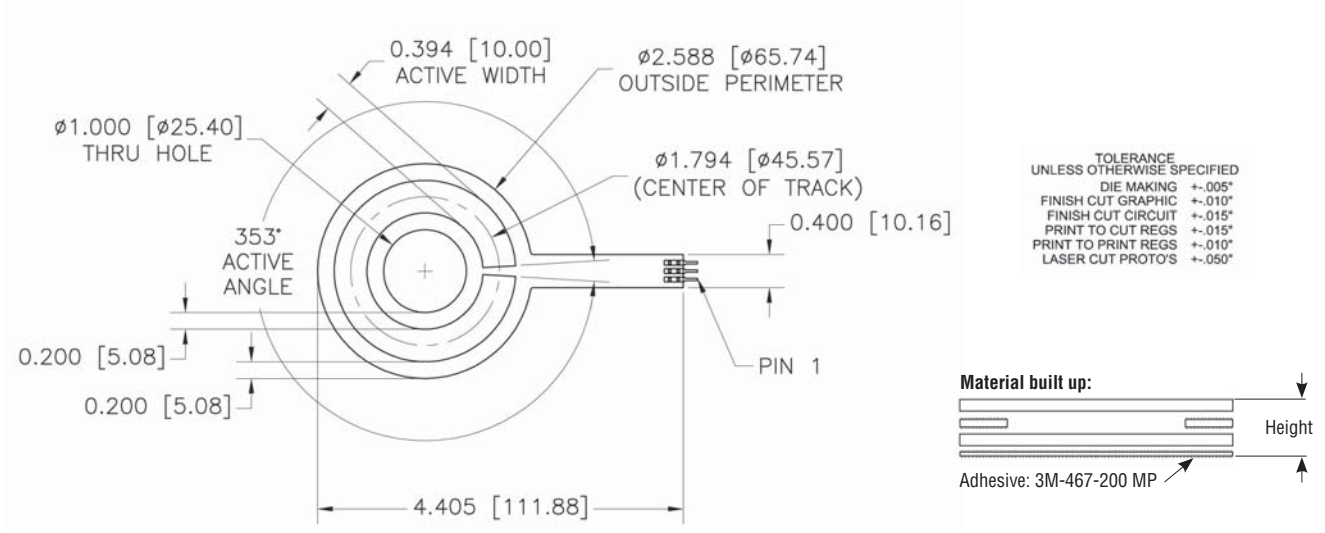

Connection

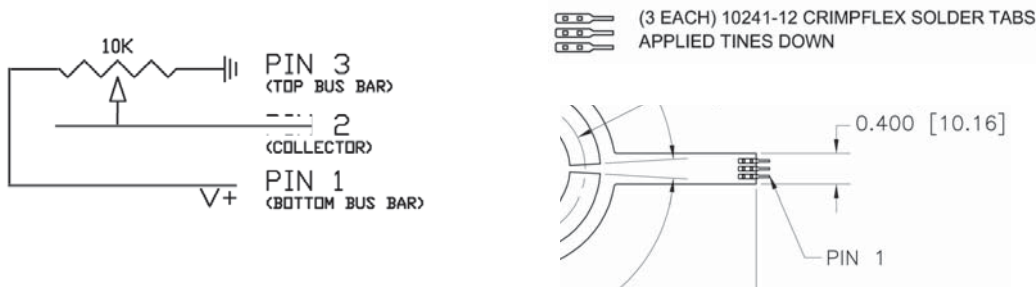

How to Order

Type-	Model-	Center of active track/	Active angle-	Resistance-	Connector type-
Example: SP-R-0046/0353-103-ST					
SP = SoftPot HP = HotPot EP = ShieldedPot	R = Rotary	0046 = 45,57 mm	0353 = 353°	102 = 1 KOhm 502 = 5 KOhm 103 = 10 KOhm 203 = 20 KOhm	ST = Solder Tabs MP = Male Pins RF = Receptacles Female RH = Receptacles Housing ⁽¹⁾

Bold marked partnumbers are preferred parts, all other parts will be produced after order and may have price adders.

⁽¹⁾We recommend Nicomatic Housing. Details must be specified.

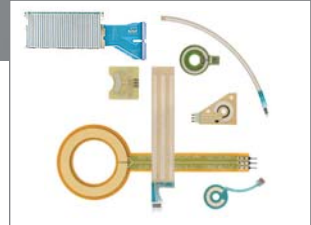

SoftPot

ShieldedPot

HotPot

Customer (Distributor's customer)	State *	ZIP	City

* State: A = Austria; CH = Swiss; D = Germany; E = Spain; F = France; HR = Croatia; I = Italy, UK = United Kingdom; B = Belgium, CZ = Czech Rep.; DK = Denmark; FIN = Finland; H = Hungaria; IL = Israel; IRL = Ireland; L = Luxembourg; M = Malta; NL = Netherlands; N = Norway; P = Portugal; PL = Poland; RO = Romania; RUS = Russia; S = Sweden; SCG = Serbia+Montenegro; SK = Slovakia; SLO = Slovenia; SU = Serbia/Montenegro; TR = Turkey

Project Reference:

Mechanical Data	recommended standards	possible values	Customer request
Rectilinear			
Part length	65 to 515 mm	10 - 2400 mm	mm
Overall width	7.5 to 25 mm	on request	mm
Active area width	4 to 12 mm	on request	mm
Active area length	50 to 500 mm	10 - 2300	mm
Rotary			
Outside diameter	25 to 450 mm	on request	mm
Inside diameter	outside dia. -15mm	on request	mm
Active area width	4 to 12 mm	on request	mm
Active area degrees	353°	on request	°
Position of active area, sketch or drawing attached <input type="checkbox"/>			
Tail length or extension	min. 13 mm	on request	mm
Seal conditions	meet IP 66	Vent on request	
Operating Temp.: SoftPot:	-40°C to 75°C		°C
ShieldedPot:	-40°C to 75°C		°C
HotPot:	-40°C to 125°C		°C
Life cycles	depending on wiper 1 cycle: move 90% electr. travel and back		Million
Dithers	cycles x5		Million
Wiper force	0.5N to 5.0N (details see specification)		N
Custom drawing, fill in:	<input type="text"/>		
Connector type, fill in:	<input type="text"/>		
Electrical Data (rectilinear, rotary)			
Resistance	10kΩ to 20kΩ	1kΩ to 100kΩ	kΩ
Resistance Tolerance	±20%	on request	%
Linearity, independent	±3% for rectilinear ±5% for rotary	on request	%
Operating Voltage	<10 Volt	on request	Watt

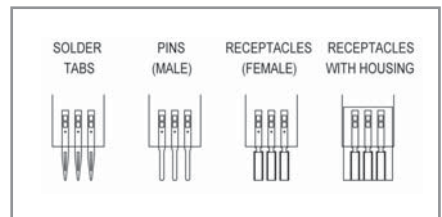
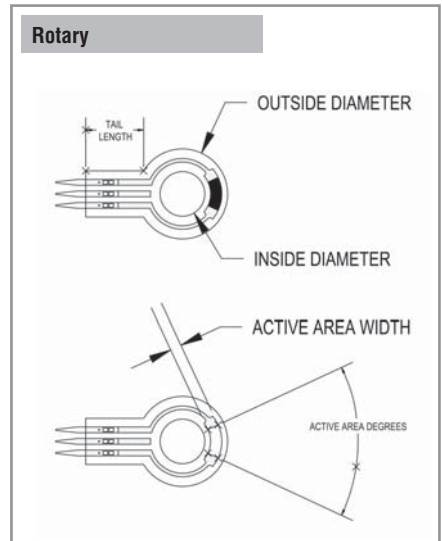
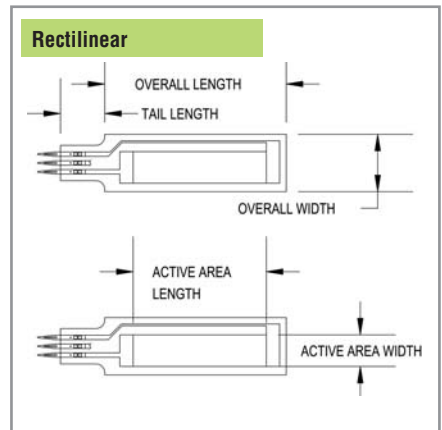

Crimp connector types

Describe your application

Wiper

The wiper can be easily integrated into the application.

The pictures on the left and on the right show typical wiper constructions. With small quantities, an off-the-shelf solution might be easier, while with higher quantities or space limitations a custom wiper may be required.

One application requires a spring-loaded screw, another will require a spring-plate attached to Delrin plastic; each application is particular to the needs of space and cost.

In the highest life-cycle requirements, a rolling wiper is recommended. As rule of thumb a spherical wiper with diameters from 1.5mm to 3mm is recommended. The wiper covers of 10% to 50% the active width. Materials such as most injection molded hard plastics, nylon, brass and aluminum will work well with the SoftPot potentiometer, while Delrin/Delron plastic, steel and other very hard surfaces work well with the HotPot potentiometer.

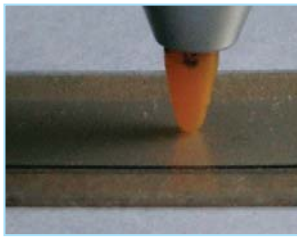

Regarding contact pressure, Spectra Symbol recommends different pressure based on the model of membrane potentiometer, but the contact pressure will almost always be within the broad range of 0.5 Newtons to 5 Newtons. It is advisable to seek the advice of the Spectra Symbol engineering department in contact wiper decisions, as the selection of the correct wiper (material, form) can affect the life cycle and electrical output of the membrane potentiometer.

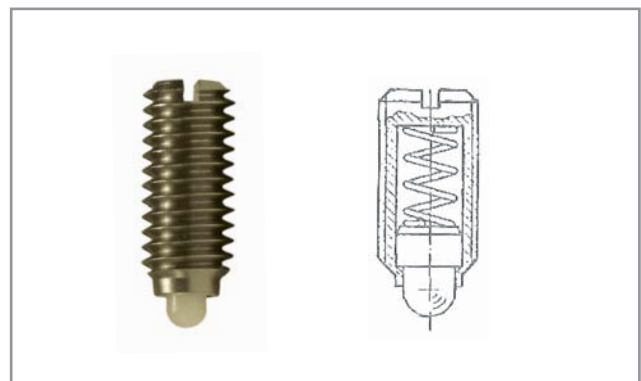

Picture: Standard wiper (Customized wiper on request)

Connectors



Example for housings



Flat to flat



Round to flat

Variety connector combinations ...

- ... flat to PCB
- ... flat to round (wire)
- ... flat to your needs on request

Details for connector you will find:

- www.nicomatic.com (English, French)
- www.dico-electronic.de (German)

We recommend Nicomatic contacts.

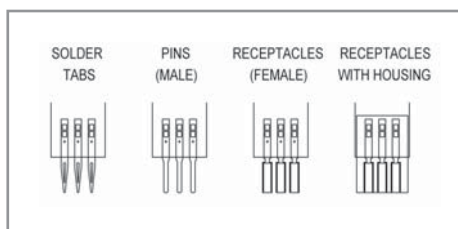

Crimp connector types

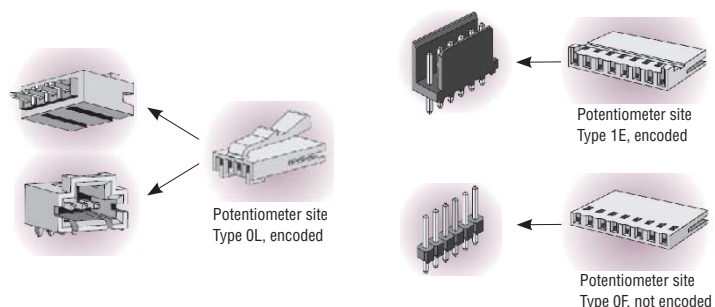

1 product for many applications

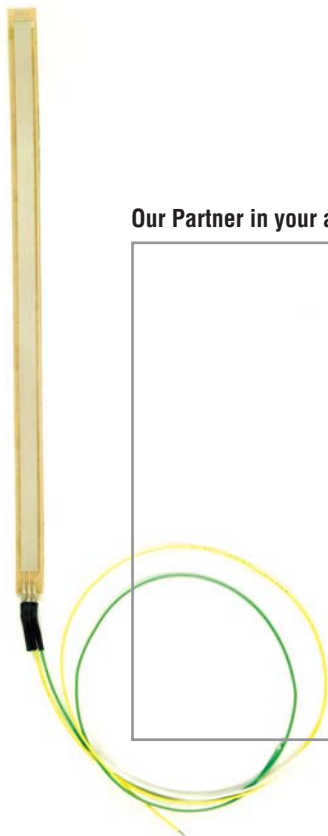
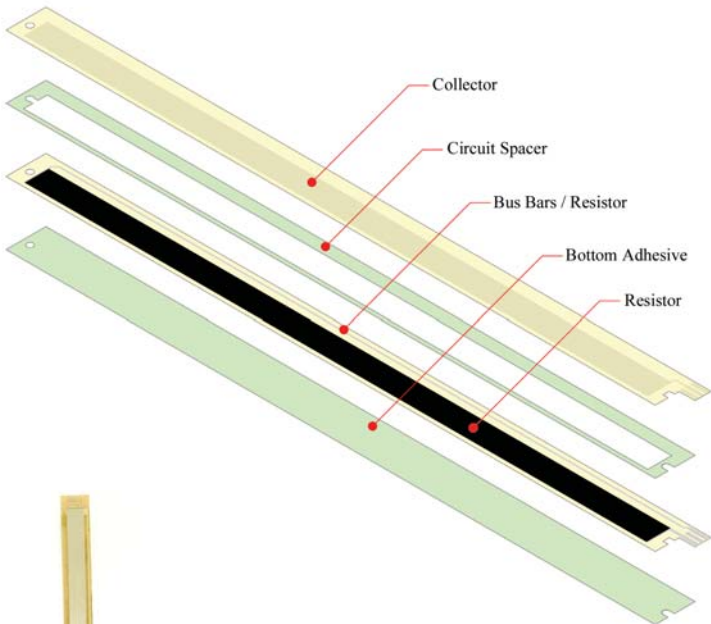
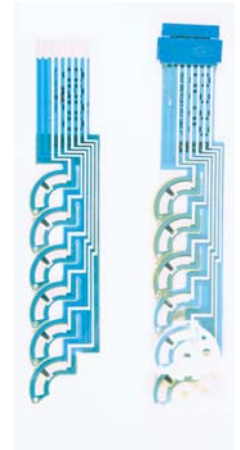

Our Partner in your area:

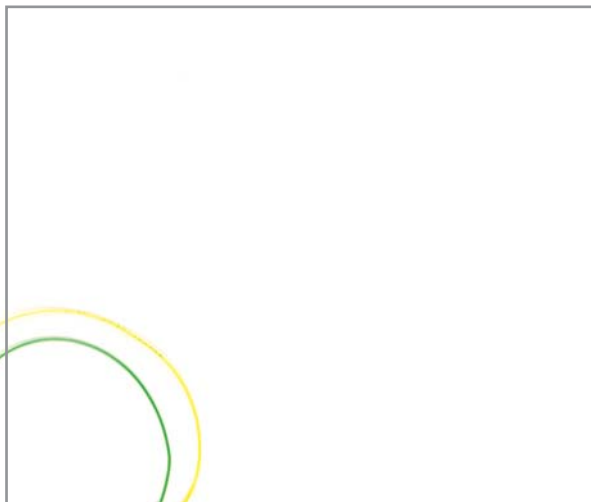

Spectra Symbol

3101 W · 2100 S · Salt Lake City · UT 84119

Tel. 801-972-6995

info@spectrasymbol.com

www.spectrasymbol.com

