



N-Channel Depletion-Mode Vertical DMOS FETs

Features

- ▶ High input impedance
- ▶ Low input capacitance
- ▶ Fast switching speeds
- ▶ Low on resistance
- ▶ Free from secondary breakdown
- ▶ Low input and output leakage

Applications

- ▶ Normally-on switches
- ▶ Solid state relays
- ▶ Converters
- ▶ Linear amplifiers
- ▶ Constant current sources
- ▶ Power supply circuits
- ▶ Telecom

General Description

The Supertex DN2540 is a low threshold depletion mode (normally-on) transistor utilizing an advanced vertical DMOS structure and Supertex's well-proven silicon-gate manufacturing process. This combination produces a device with the power handling capabilities of bipolar transistors and with the high input impedance and positive temperature coefficient inherent in MOS devices. Characteristic of all MOS structures, this device is free from thermal runaway and thermally-induced secondary breakdown.

Supertex's vertical DMOS FETs are ideally suited to a wide range of switching and amplifying applications where high breakdown voltage, high input impedance, low input capacitance, and fast switching speeds are desired.

Ordering Information

Device	Package Options			BV_{DSX} / BV_{DGX} (V)	$R_{DS(ON)}$ max (Ω)	I_{DSS} min (mA)
	TO-92	TO-220	TO-243AA ⁽¹⁾			
DN2540	DN2540N3-G	DN2540N5-G	DN2540N8-G	400	25	150

-G indicates package is RoHS compliant ('Green')
 (1) Same as SOT-89.



Pin Configurations

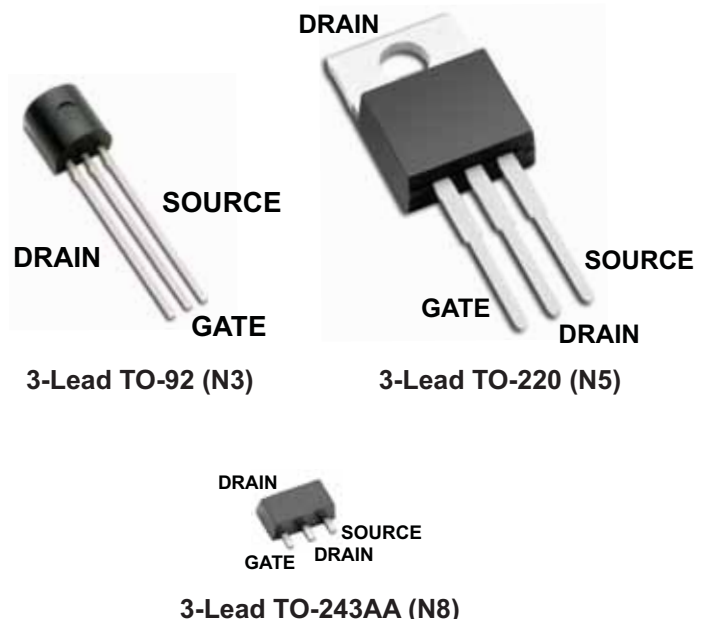

Absolute Maximum Ratings

Parameter	Value
Drain-to-source voltage	BV_{DSX}
Drain-to-gate voltage	BV_{DGX}
Gate-to-source voltage	$\pm 20V$
Operating and storage temperature	$-55^{\circ}C$ to $+150^{\circ}C$
Soldering temperature*	$300^{\circ}C$

Absolute Maximum Ratings are those values beyond which damage to the device may occur. Functional operation under these conditions is not implied. Continuous operation of the device at the absolute rating level may affect device reliability. All voltages are referenced to device ground.

*Distance of 1.6mm from case for 10 seconds.

Product Marking

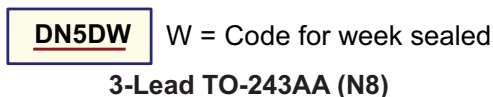
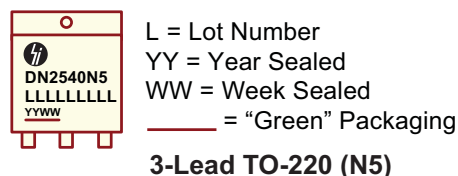
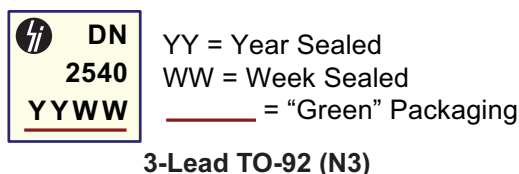

Thermal Characteristics

Package	I_D (continuous) ⁽¹⁾ (mA)	I_D (pulsed) (mA)	Power Dissipation @ $T_c = 25^\circ\text{C}$ (W)	θ_{jc} ($^\circ\text{C/W}$)	θ_{ja} ($^\circ\text{C/W}$)	$I_{DR}^{(1)}$ (mA)	I_{DRM} (mA)
TO-92	120	500	1.0	125	170	120	500
TO-220	500	500	15	8.3	70	500	500
TO-243AA	170	500	1.6 ⁽²⁾	15	78 ⁽²⁾	170	500

Notes:

- (1) I_D (continuous) is limited by max rated T_j
 (2) Mounted on FR5 board, 25mm x 25mm x 1.57mm.

Electrical Characteristics ($T_A @ 25^\circ\text{C}$ unless otherwise specified)

Sym	Parameter	Min	Typ	Max	Units	Conditions
BV_{DSX}	Drain-to-source breakdown voltage	400	-	-	V	$V_{GS} = -5.0\text{V}$, $I_D = 100\mu\text{A}$
$V_{GS(OFF)}$	Gate-to-source OFF voltage	-1.5	-	-3.5	V	$V_{DS} = 25\text{V}$, $I_D = 10\mu\text{A}$
$\Delta V_{GS(OFF)}$	Change in $V_{GS(OFF)}$ with temperature	-	-	4.5	mV/ $^\circ\text{C}$	$V_{DS} = 25\text{V}$, $I_D = 10\mu\text{A}$
I_{GSS}	Gate body leakage current	-	-	100	nA	$V_{GS} = \pm 20\text{V}$, $V_{DS} = 0\text{V}$
$I_{D(OFF)}$	Drain-to-source leakage current	-	-	10	μA	$V_{DS} = \text{Max rating}$, $V_{GS} = -10\text{V}$
		-	-	1.0	mA	$V_{DS} = 0.8 \text{ Max Rating}$, $V_{GS} = -10\text{V}$, $T_A = 125^\circ\text{C}$
I_{DSS}	Saturated drain-to-source current	150	-	-	mA	$V_{GS} = 0\text{V}$, $V_{DS} = 25\text{V}$
$R_{DS(ON)}$	Static drain-to-source ON-state resistance	-	17	25	Ω	$V_{GS} = 0\text{V}$, $I_D = 120\text{mA}$
$\Delta R_{DS(ON)}$	Change in $R_{DS(ON)}$ with temperature	-	-	1.1	%/ $^\circ\text{C}$	$V_{GS} = 0\text{V}$, $I_D = 120\text{mA}$
G_{FS}	Forward transconductance	-	325	-	mmho	$V_{DS} = 10\text{V}$, $I_D = 100\text{mA}$
C_{ISS}	Input capacitance	-	200	300	pF	$V_{GS} = -10\text{V}$, $V_{DS} = 25\text{V}$, $f = 1\text{MHz}$
C_{OSS}	Common source output capacitance	-	12	30		
C_{RSS}	Reverse transfer capacitance	-	1	5		

Sym	Parameter	Min	Typ	Max	Units	Conditions
$t_{d(ON)}$	Turn-ON delay time	-	-	10	ns	$V_{DD} = 25V,$ $I_D = 150mA,$ $R_{GEN} = 25\Omega,$
t_r	Rise time	-	-	15		
$t_{d(OFF)}$	Turn-OFF delay time	-	-	15		
t_f	Fall time	-	-	20		
V_{SD}	Diode forward voltage drop	-	-	1.8	V	$V_{GS} = -10V, I_{SD} = 120mA$
t_{rr}	Reverse recovery time	-	800	-	ns	$V_{GS} = -10V, I_{SD} = 1.0A$

Notes:

1. All D.C. parameters 100% tested at 25°C unless otherwise stated. (Pulse test: 300µs pulse, 2% duty cycle.)
2. All A.C. parameters sample tested.

Switching Waveforms and Test Circuit

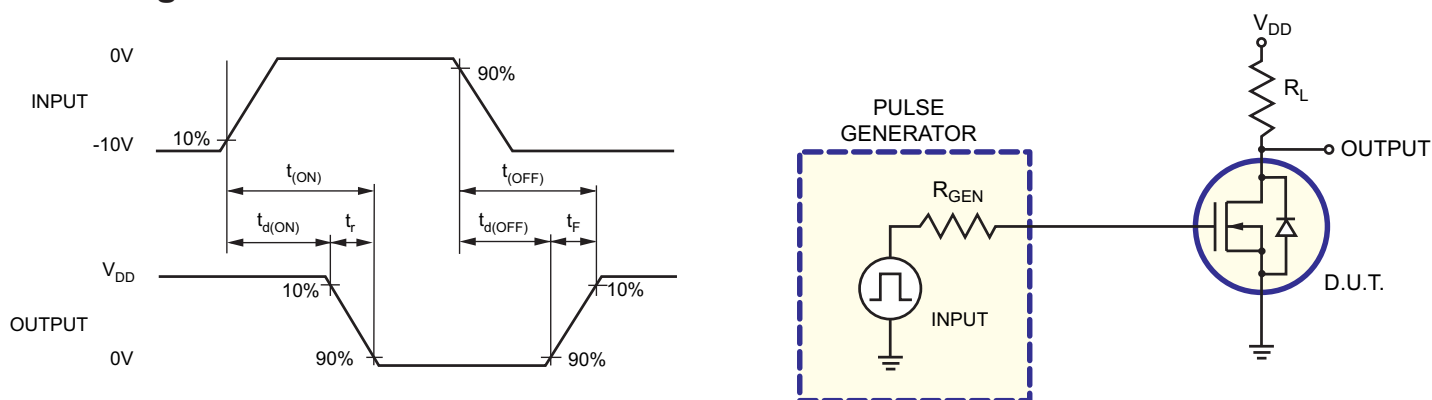

Typical Performance Curves

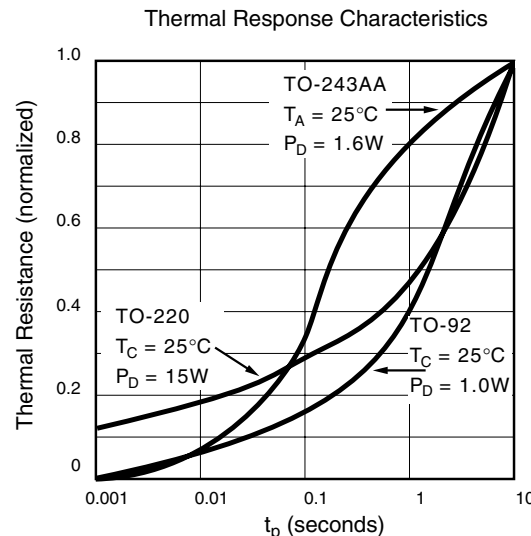
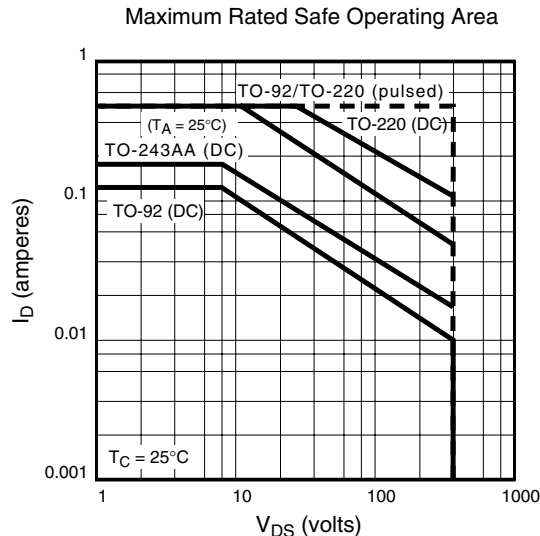
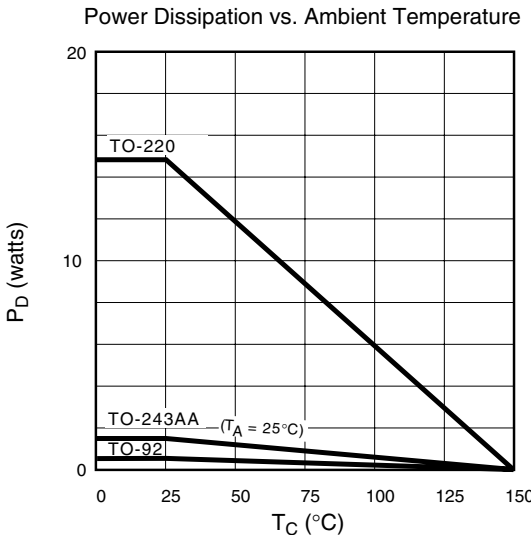
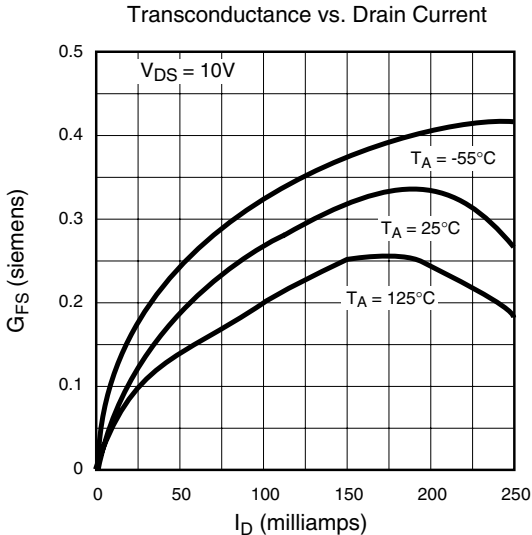
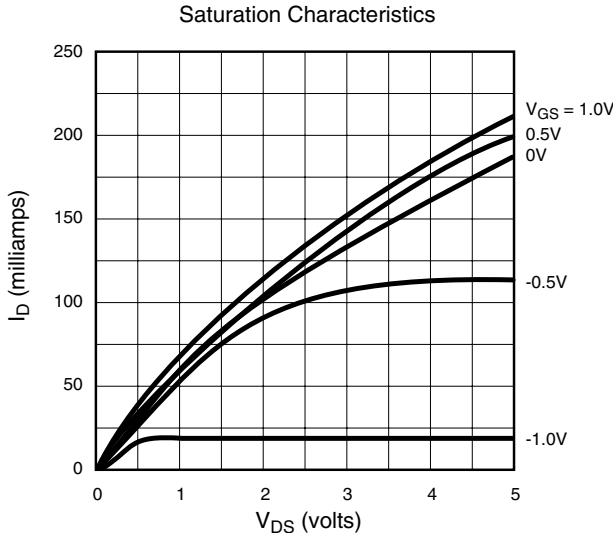
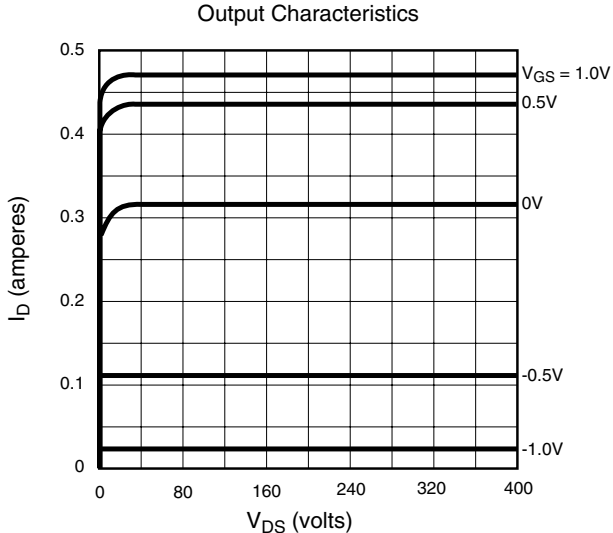

Typical Performance Curves (cont.)

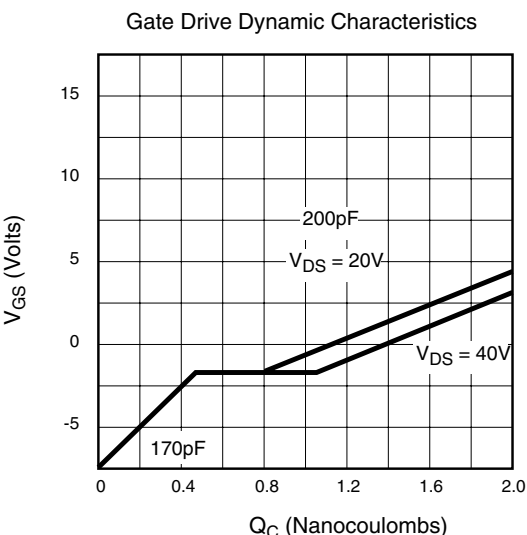
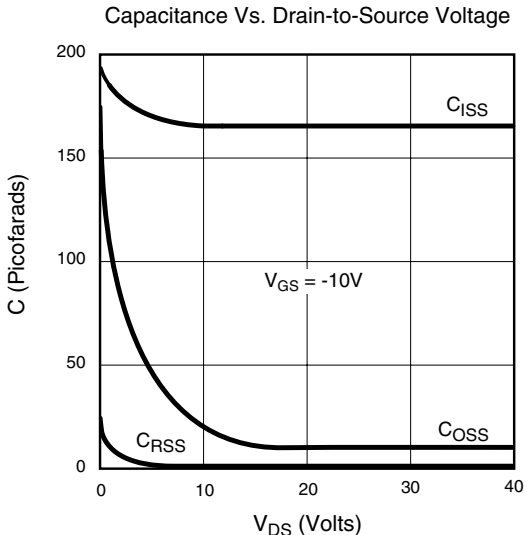
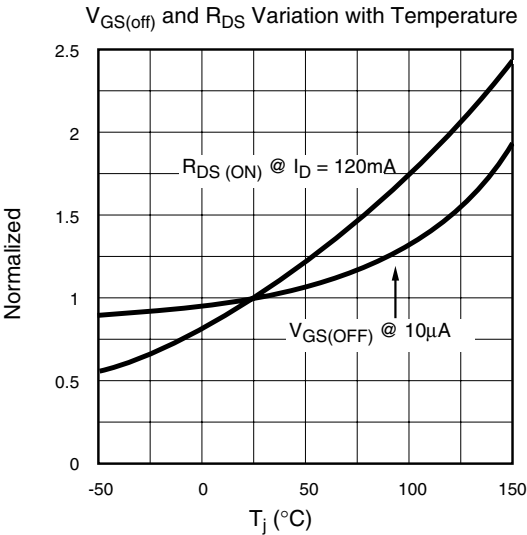
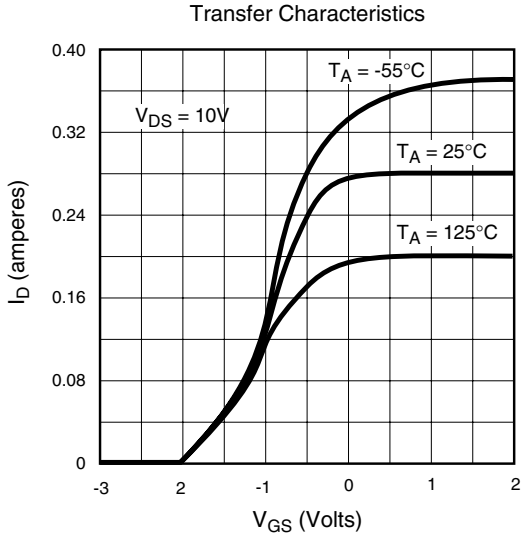
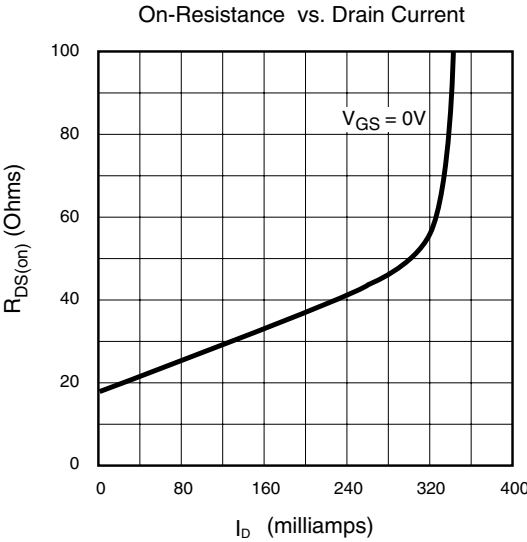
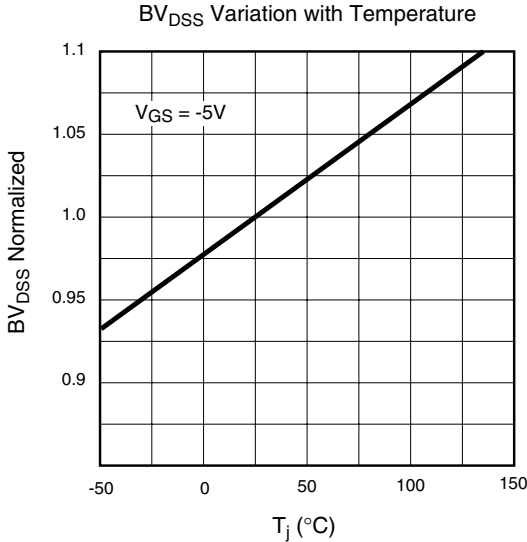

3-Lead TO-92 Package Outline (N3)

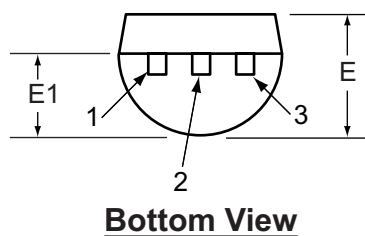
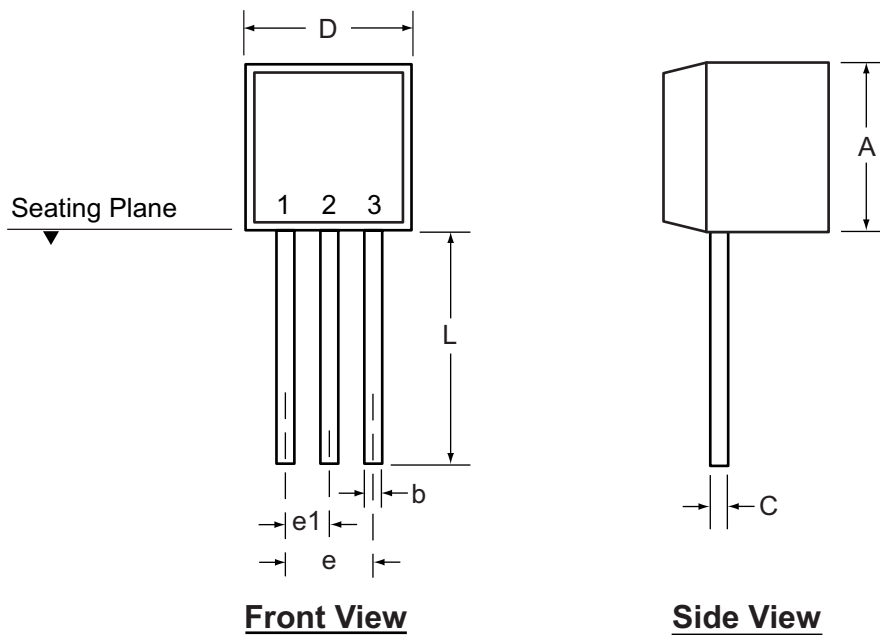

Symbol		A	b	C	D	E	E1	e	e1	L
Dimension (inches)	MIN	.170	.014	.014	.175	.125	.080	.095	.045	.500
	NOM	-	-	-	-	-	-	-	-	-
	MAX	.210	.022	.022	.205	.165	.105	.105	.055	-

Drawings not to scale.

3-Lead TO-220 (Power Package) Package Outline (N5)

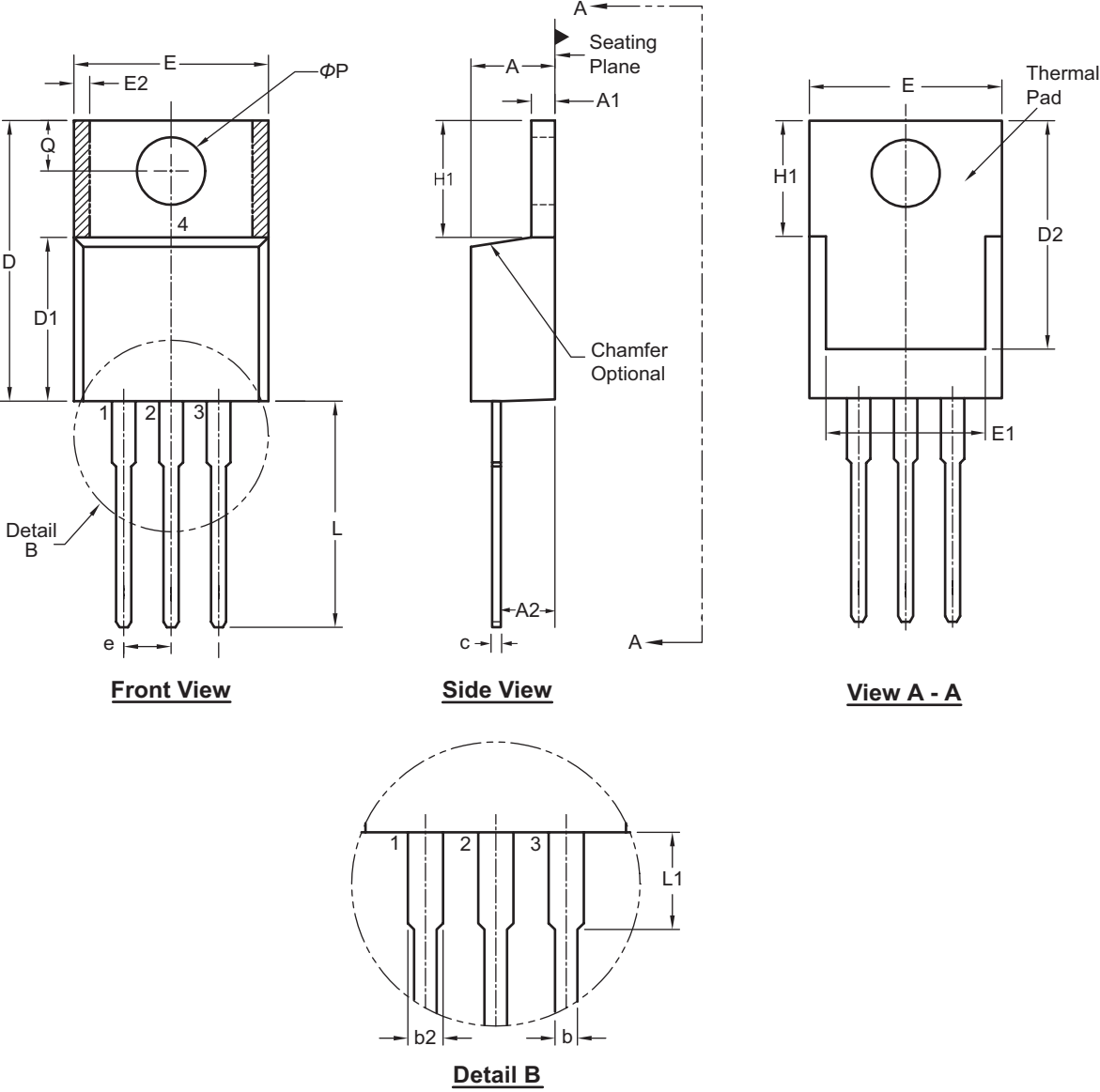

Symbol	A	A1	A2	b	b2	c	D	D1	D2	E	E1	E2	e	H1	L	L1	Q	ΦP		
Dimension (inches)	MIN	.140	.020	.080	.015	.045	.014	.560	.330	.480	.380	.270	-	.100 BSC	.230	.500	-	.100	.139	
	NOM	-	-	-	.027	.057	-	-	-	-	-	-	-		-	-	-	-	-	-
	MAX	.190	.055	.115	.040	.070	.024	.650	.355	.507	.420	.350	.030		.270	.580	.250	.135	.161	

JEDEC Registration TO-220, Variation AB, Issue K, April 2002.
 Drawings not to scale.

3-Lead TO-243AA (SOT-89) Package Outline (N8)

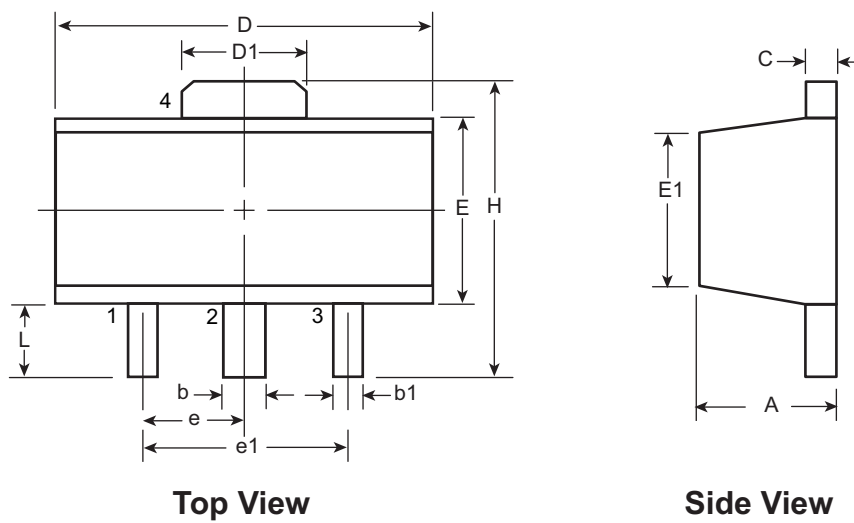

Symbol		A	b	b1	C	D	D1	E	E1	e	e1	H	L	
Dimensions (mm)	MIN	1.40	0.44	0.36	0.35	4.40	1.62	2.29	2.13	1.50 BSC	3.00 BSC	3.94	0.89	
	NOM	-	-	-	-	-	-	-	-			-	-	-
	MAX	1.60	0.56	0.48	0.44	4.60	1.83	2.60	2.29			4.25	1.20	

JEDEC Registration TO-243, Variation AA, Issue C, July 1986.
Drawings not to scale.

(The package drawing(s) in this data sheet may not reflect the most current specifications. For the latest package outline information go to <http://www.supertex.com/packaging.html>.)

Supertex inc. does not recommend the use of its products in life support applications, and will not knowingly sell its products for use in such applications, unless it receives an adequate "product liability indemnification insurance agreement". **Supertex** does not assume responsibility for use of devices described and limits its liability to the replacement of the devices determined defective due to workmanship. No responsibility is assumed for possible omissions or inaccuracies. Circuitry and specifications are subject to change without notice. For the latest product specifications, refer to the **Supertex** website: <http://www.supertex.com>.

©2007 **Supertex inc.** All rights reserved. Unauthorized use or reproduction is prohibited.

Supertex inc.
 1235 Bordeaux Drive, Sunnyvale, CA 94089
 TEL: (408) 222-8888 / FAX: (408) 222-4895
www.supertex.com