

NE5534, NE5534A LOW-NOISE OPERATIONAL AMPLIFIERS

SLOS070A – JULY 1979 – REVISED MARCH 2003

- Equivalent Input Noise Voltage . . . **3.5 nV/√Hz**
- Unity-Gain Bandwidth . . . **10 MHz Typ**
- Common-Mode Rejection Ratio . . . **100 dB Typ**
- High DC Voltage Gain . . . **100 V/mV Typ**
- Peak-to-Peak Output Voltage Swing **32 V Typ With $V_{CC\pm} = \pm 18\text{ V}$ and $R_L = 600\ \Omega$**
- High Slew Rate . . . **13 V/μs Typ**
- Wide Supply Voltage Range **$\pm 3\text{ V}$ to $\pm 20\text{ V}$**
- Low Harmonic Distortion
- Designed To Be Interchangeable With Signetics NE5534 and NE5534A

NE5534 . . . D, P, OR PS PACKAGE
NE5534A . . . D OR P PACKAGE
(TOP VIEW)

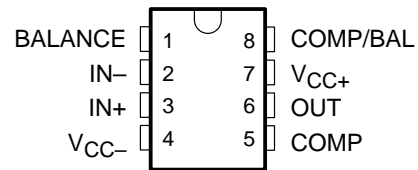

description/ordering information

The NE5534 and NE5534A are high-performance operational amplifiers combining excellent dc and ac characteristics. Some of the features include very low noise, high output drive capability, high unity-gain and maximum-output-swing bandwidths, low distortion, and high slew rate.

These operational amplifiers are internally compensated for a gain equal to or greater than three. Optimization of the frequency response for various applications can be obtained by use of an external compensation capacitor between COMP and COMP/BAL. The devices feature input-protection diodes, output short-circuit protection, and offset-voltage nulling capability.

For the NE5534A, a maximum limit is specified for equivalent input noise voltage.

ORDERING INFORMATION

T_A	V_{IOmax} AT 25°C	PACKAGE†		ORDERABLE PART NUMBER	TOP-SIDE MARKING	
0°C to 70°C	4 mV	PDIP (P)	Tube of 50	NE5534P	NE5534P	
			Tube of 50	NE5534AP	NE5534AP	
		SOIC (D)	Tube of 75	NE5534D	NE5534	
			Reel of 2500	NE5534DR		
			Tube of 75	NE5534AD	5534A	
				Reel of 2500	NE5534ADR	
		SOP (PS)	Reel of 2000	NE5534PS	N5534	

† Package drawings, standard packing quantities, thermal data, symbolization, and PCB design guidelines are available at www.ti.com/sc/package.

symbol

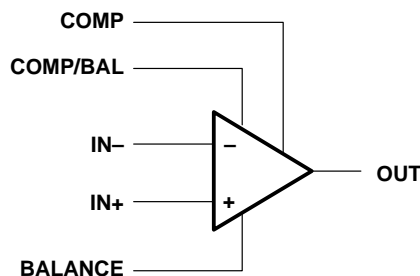

PRODUCTION DATA information is current as of publication date. Products conform to specifications per the terms of Texas Instruments standard warranty. Production processing does not necessarily include testing of all parameters.

 **TEXAS
INSTRUMENTS**

POST OFFICE BOX 655303 • DALLAS, TEXAS 75265

Copyright © 2003, Texas Instruments Incorporated

NE5534, NE5534A LOW-NOISE OPERATIONAL AMPLIFIERS

SLOS070A – JULY 1979 – REVISED MARCH 2003

schematic

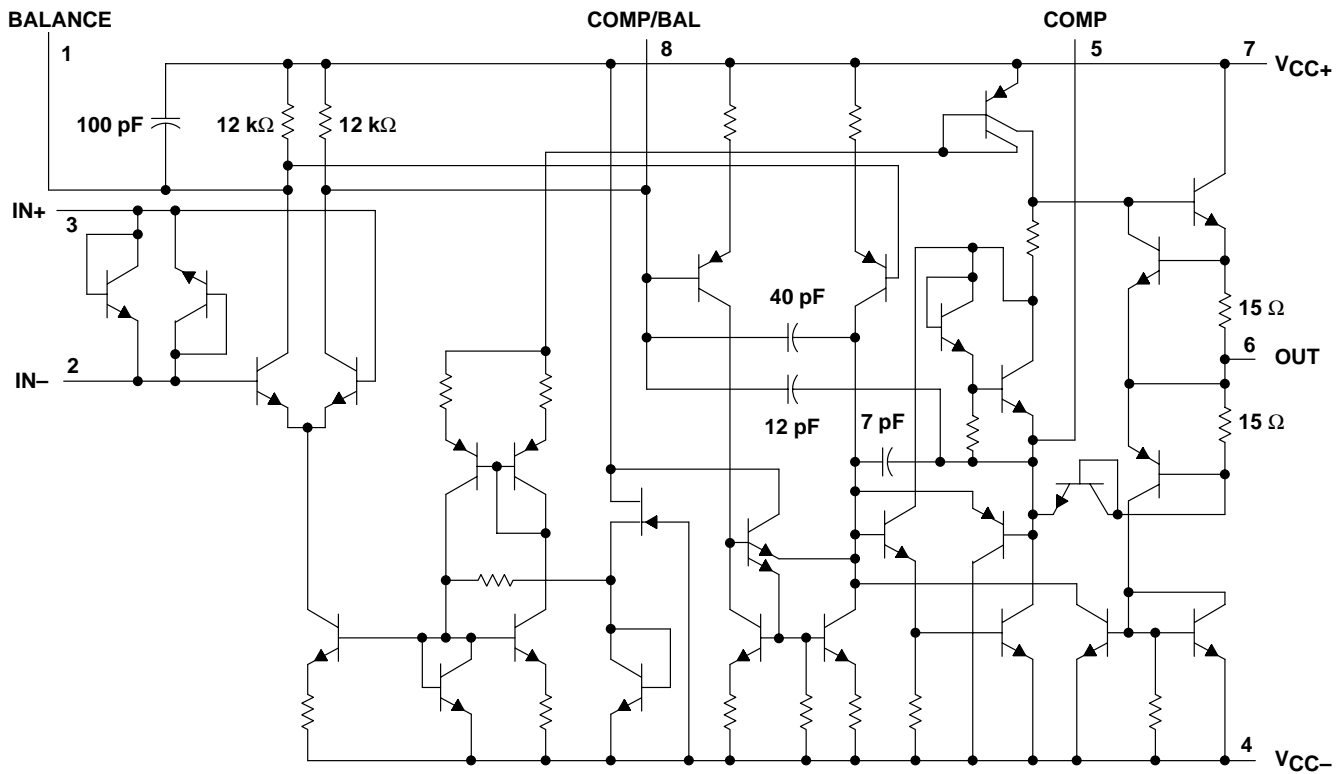

All component values shown are nominal.

absolute maximum ratings over operating free-air temperature range (unless otherwise noted)†

Supply voltage: V_{CC+} (see Note 1)	22 V
V_{CC-} (see Note 1)	–22 V
Input voltage either input (see Notes 1 and 2)	V_{CC+}
Input current (see Note 3)	±10 mA
Duration of output short circuit (see Note 4)	Unlimited
Package thermal impedance, θ_{JA} (see Notes 5 and 6): D package	97°C/W
P package	85°C/W
PS package	95°C/W
Operating virtual junction temperature, T_J	150°C
Lead temperature range 1,6 mm (1/16 inch) from case for 10 seconds	260°C
Storage temperature range, T_{Stg}	–65°C to 150°C

† Stresses beyond those listed under “absolute maximum ratings” may cause permanent damage to the device. These are stress ratings only, and functional operation of the device at these or any other conditions beyond those indicated under “recommended operating conditions” is not implied. Exposure to absolute-maximum-rated conditions for extended periods may affect device reliability.

- NOTES:
1. All voltage values, except differential voltages, are with respect to the midpoint between V_{CC+} and V_{CC-} .
 2. The magnitude of the input voltage must never exceed the magnitude of the supply voltage.
 3. Excessive current will flow if a differential input voltage in excess of approximately 0.6 V is applied between the inputs unless some limiting resistance is used.
 4. The output may be shorted to ground or to either power supply. Temperature and/or supply voltages must be limited to ensure the maximum dissipation rating is not exceeded.
 5. Maximum power dissipation is a function of $T_{J(max)}$, θ_{JA} , and T_A . The maximum allowable power dissipation at any allowable ambient temperature is $P_D = (T_{J(max)} - T_A)/\theta_{JA}$. Operating at the absolute maximum T_J of 150°C can affect reliability.
 6. The package thermal impedance is calculated in accordance with JESD 51-7.

recommended operating conditions

	MIN	MAX	UNIT
V_{CC+} Supply voltage	5	15	V
V_{CC-} Supply voltage	–5	–15	V

NE5534, NE5534A

LOW-NOISE OPERATIONAL AMPLIFIERS

SLOS070A – JULY 1979 – REVISED MARCH 2003

electrical characteristics, $V_{CC\pm} = \pm 15\text{ V}$, $T_A = 25^\circ\text{C}$ (unless otherwise noted)

PARAMETER		TEST CONDITIONS†		MIN	TYP	MAX	UNIT
V_{IO}	Input offset voltage	$V_O = 0$, $R_S = 50\ \Omega$	$T_A = 25^\circ\text{C}$	0.5	4		mV
			$T_A = \text{Full range}$			5	
I_{IO}	Input offset current	$V_O = 0$	$T_A = 25^\circ\text{C}$	20	300		nA
			$T_A = \text{Full range}$			400	
I_{IB}	Input bias current	$V_O = 0$	$T_A = 25^\circ\text{C}$	500	1500		nA
			$T_A = \text{Full range}$			2000	
V_{ICR}	Common-mode input voltage range			± 12	± 13		V
$V_{O(PP)}$	Maximum peak-to-peak output voltage swing	$R_L \geq 600\ \Omega$	$V_{CC\pm} = \pm 15\text{ V}$	24	26		V
			$V_{CC\pm} = \pm 18\text{ V}$	30	32		
A_{VD}	Large-signal differential voltage amplification	$V_O = \pm 10\text{ V}$, $R_L \geq 600\ \Omega$	$T_A = 25^\circ\text{C}$	25	100		V/mV
			$T_A = \text{Full range}$	15			
A_{vd}	Small-signal differential voltage amplification	$f = 10\text{ kHz}$	$C_C = 0$		6		V/mV
			$C_C = 22\text{ pF}$		2.2		
B_{OM}	Maximum-output-swing bandwidth	$V_O = \pm 10\text{ V}$	$C_C = 0$		200		kHz
			$C_C = 22\text{ pF}$		95		
			$V_{CC\pm} = \pm 18\text{ V}$, $R_L \geq 600\ \Omega$, $V_O = \pm 14\text{ V}$, $C_C = 22\text{ pF}$		70		
B_1	Unity-gain bandwidth	$C_C = 22\text{ pF}$,	$C_L = 100\text{ pF}$		10		MHz
r_i	Input resistance			30	100		k Ω
z_o	Output impedance	$A_{VD} = 30\text{ dB}$, $C_C = 22\text{ pF}$,	$R_L \geq 600\ \Omega$, $f = 10\text{ kHz}$		0.3		Ω
CMRR	Common-mode rejection ratio	$V_O = 0$, $R_S = 50\ \Omega$	$V_{IC} = V_{ICRmin}$,	70	100		dB
kSVR	Supply voltage rejection ratio ($\Delta V_{CC}/\Delta V_{IO}$)	$V_{CC+} = \pm 9\text{ V to } \pm 15\text{ V}$, $V_O = 0$	$R_S = 50\ \Omega$,	80	100		dB
I_{OS}	Output short-circuit current				38		mA
I_{CC}	Supply current	$V_O = 0$, No load	$T_A = 25^\circ\text{C}$		4	8	mA

† All characteristics are measured under open-loop conditions with zero common-mode input voltage, unless otherwise specified. Full range is $T_A = 0^\circ\text{C to } 70^\circ\text{C}$.



operating characteristics, $V_{CC} \pm = \pm 15\text{ V}$, $T_A = 25^\circ\text{C}$

PARAMETER		TEST CONDITIONS	NE5534	NE5534A		UNIT
			TYP	MIN	TYP	
SR	Slew rate at unity gain	$C_C = 0$	13	13		V/ μs
		$C_C = 22\text{ pF}$	6	6		
t_r	Rise time	$V_I = 50\text{ mV}$, $A_{VD} = 1$, $R_L = 600\ \Omega$, $C_C = 22\text{ pF}$,	20	20		ns
	Overshoot factor	$C_L = 100\text{ pF}$	20	20		%
t_r	Rise time	$V_I = 50\text{ mV}$, $A_{VD} = 1$, $R_L = 600\ \Omega$, $C_C = 47\text{ pF}$,	50	50		ns
	Overshoot factor	$C_L = 500\text{ pF}$	35	35		%
V_n	Equivalent input noise voltage	$f = 30\text{ Hz}$	7	5.5	7	nV/ $\sqrt{\text{Hz}}$
		$f = 1\text{ kHz}$	4	3.5	4.5	
I_n	Equivalent input noise current	$f = 30\text{ Hz}$	2.5	1.5		pA/ $\sqrt{\text{Hz}}$
		$f = 1\text{ kHz}$	0.6	0.4		
\bar{F}	Average noise figure	$R_S = 5\text{ k}\Omega$, $f = 10\text{ Hz to } 20\text{ kHz}$	0.9		dB	

TYPICAL CHARACTERISTICS†

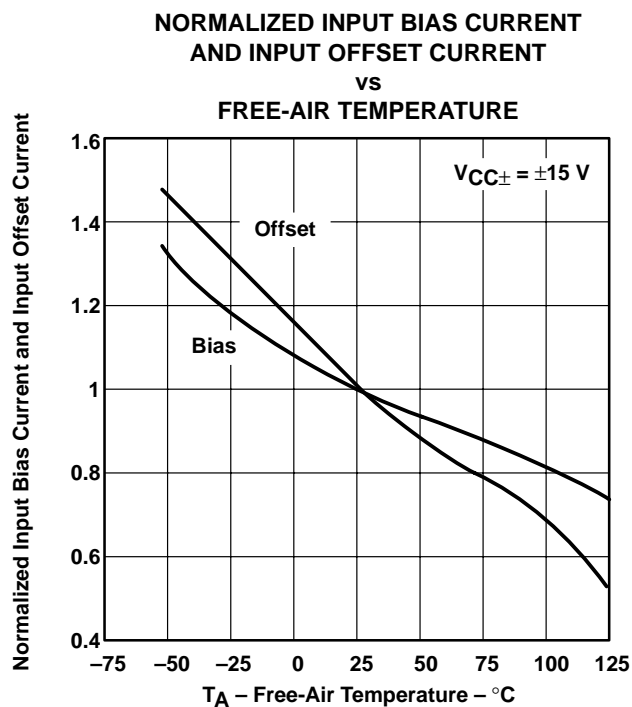

Figure 1

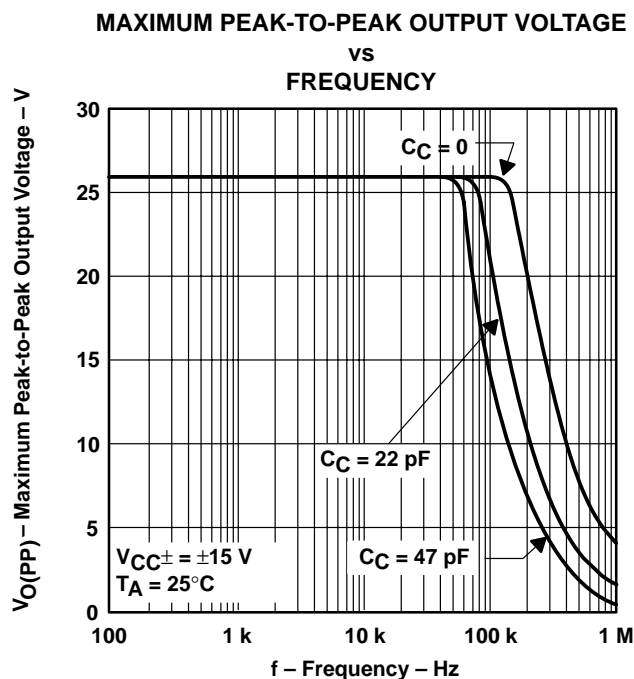

Figure 2

† Data at high and low temperatures are applicable only within the rated operating free-air temperature ranges of the various devices.

NE5534, NE5534A LOW-NOISE OPERATIONAL AMPLIFIERS

SLOS070A – JULY 1979 – REVISED MARCH 2003

TYPICAL CHARACTERISTICS†

**LARGE-SIGNAL
DIFFERENTIAL VOLTAGE AMPLIFICATION
VS
FREQUENCY**

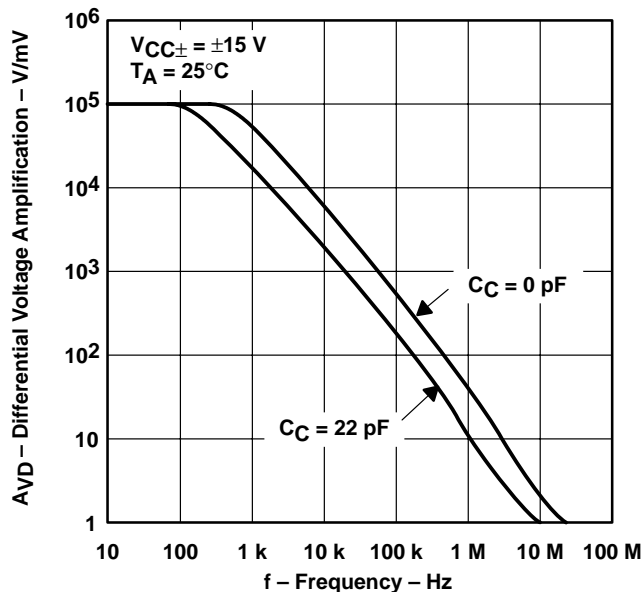

Figure 3

**NORMALIZED SLEW RATE AND
UNITY-GAIN BANDWIDTH
VS
SUPPLY VOLTAGE**

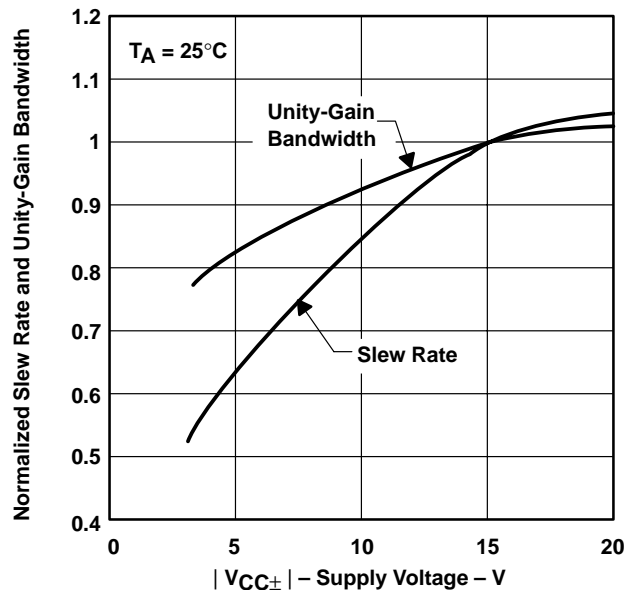

Figure 4

**NORMALIZED SLEW RATE AND
UNITY-GAIN BANDWIDTH
VS
FREE-AIR TEMPERATURE**

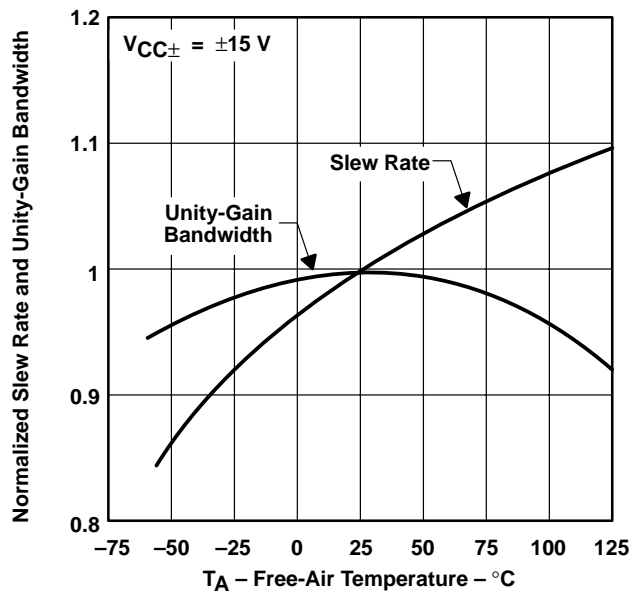

Figure 5

**TOTAL HARMONIC DISTORTION
VS
FREQUENCY**

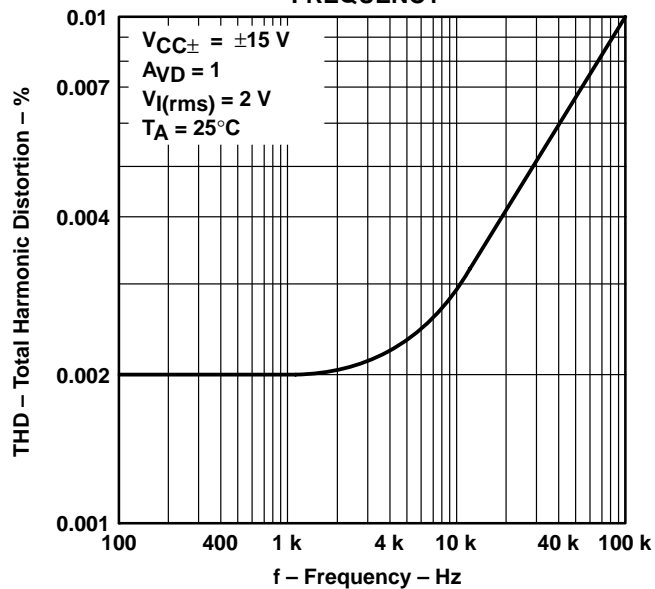

Figure 6

† Data at high and low temperatures are applicable only within the rated operating free-air temperature ranges of the various devices.



TYPICAL CHARACTERISTICS

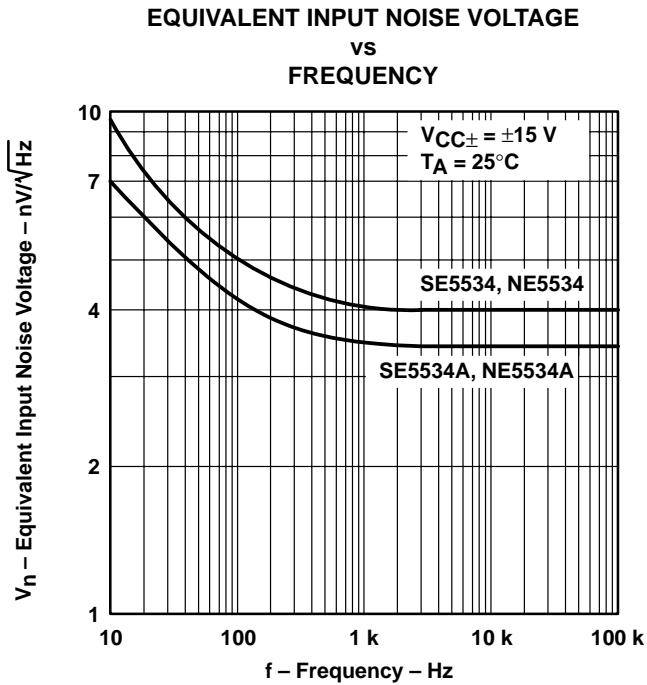

Figure 7

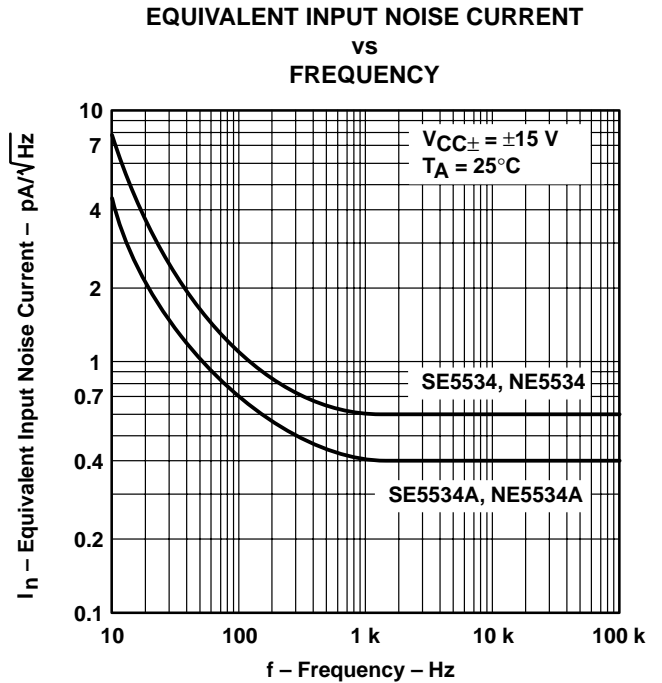

Figure 8

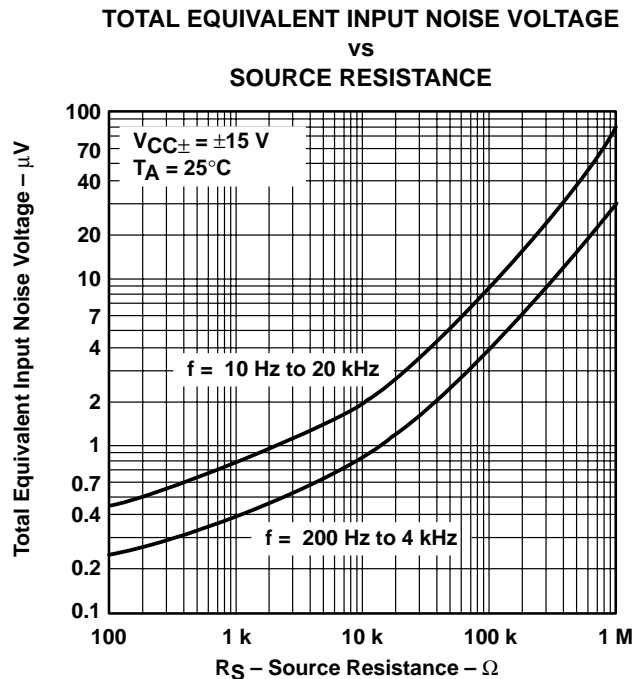

Figure 9

JG (R-GDIP-T8)

CERAMIC DUAL-IN-LINE



- NOTES: A. All linear dimensions are in inches (millimeters).
 B. This drawing is subject to change without notice.
 C. This package can be hermetically sealed with a ceramic lid using glass frit.
 D. Index point is provided on cap for terminal identification.
 E. Falls within MIL STD 1835 GDIP1-T8

P (R-PDIP-T8)

PLASTIC DUAL-IN-LINE



- NOTES: A. All linear dimensions are in inches (millimeters).
 B. This drawing is subject to change without notice.
 C. Falls within JEDEC MS-001

For the latest package information, go to http://www.ti.com/sc/docs/package/pkg_info.htm

D (R-PDSO-G**)

PLASTIC SMALL-OUTLINE PACKAGE

8 PINS SHOWN

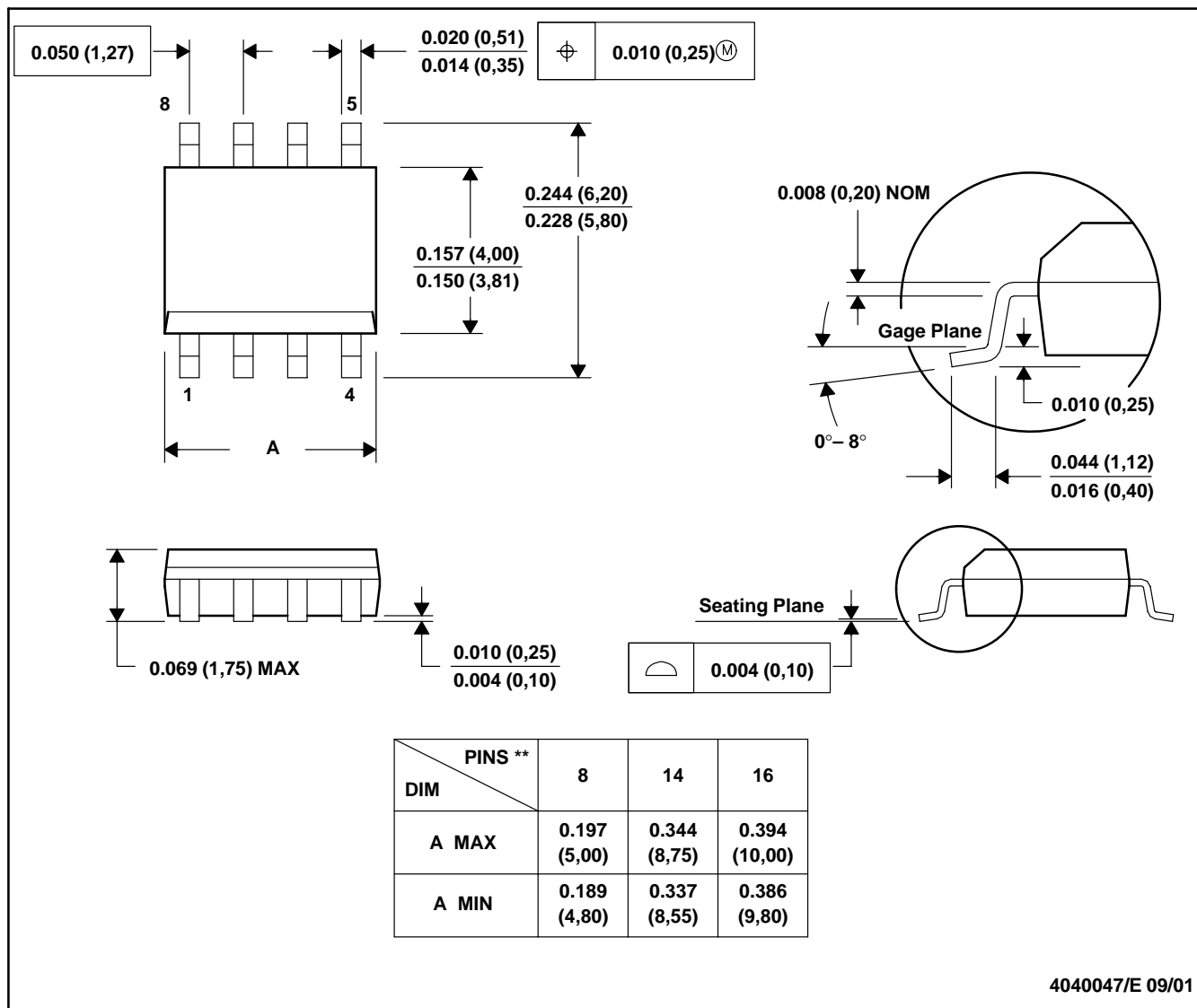

- NOTES: A. All linear dimensions are in inches (millimeters).
 B. This drawing is subject to change without notice.
 C. Body dimensions do not include mold flash or protrusion, not to exceed 0.006 (0,15).
 D. Falls within JEDEC MS-012

PS (R-PDSO-G8)

PLASTIC SMALL-OUTLINE PACKAGE

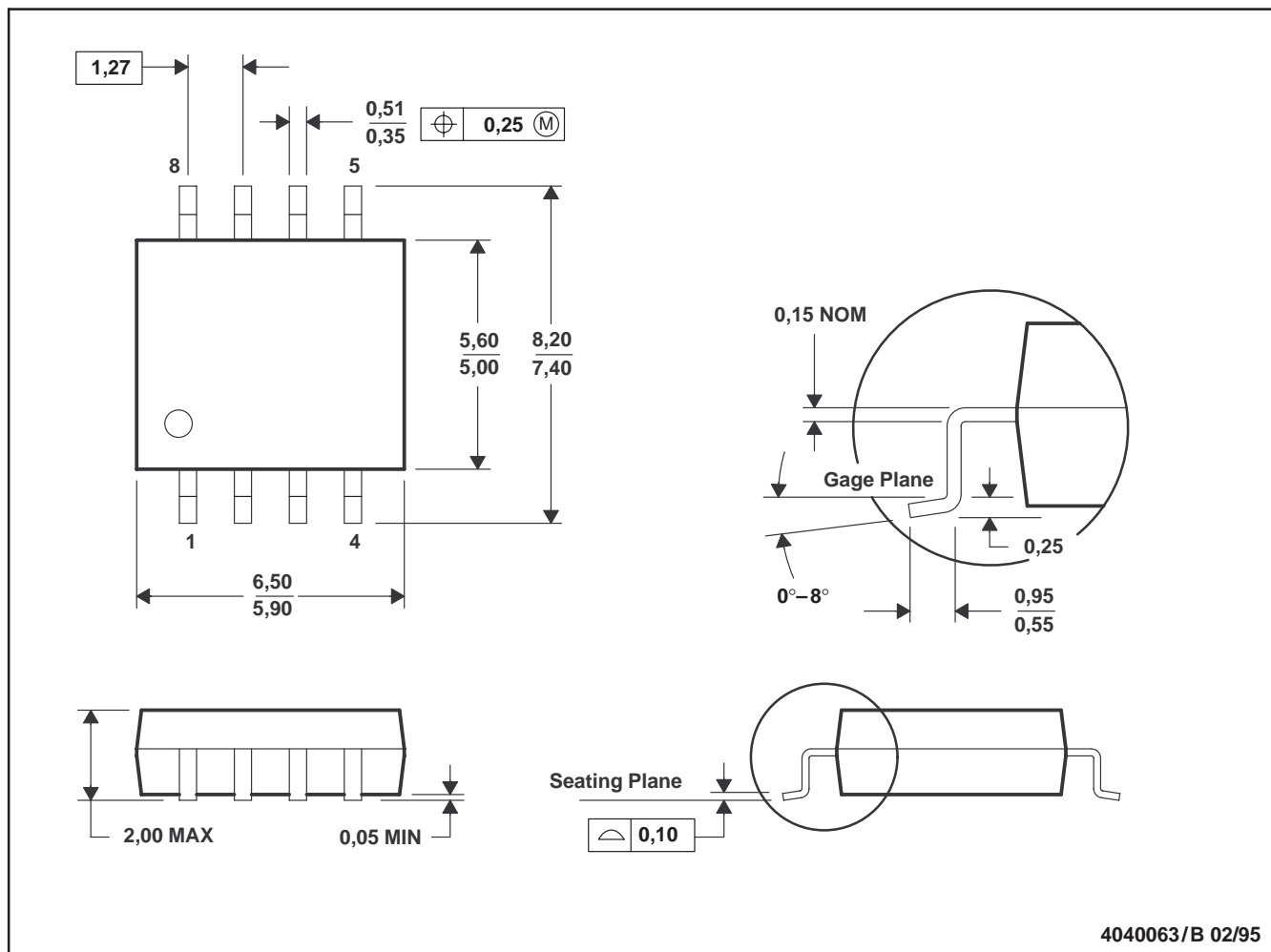

- NOTES: A. All linear dimensions are in millimeters.
 B. This drawing is subject to change without notice.
 C. Body dimensions do not include mold flash or protrusion, not to exceed 0,15.

IMPORTANT NOTICE

Texas Instruments Incorporated and its subsidiaries (TI) reserve the right to make corrections, modifications, enhancements, improvements, and other changes to its products and services at any time and to discontinue any product or service without notice. Customers should obtain the latest relevant information before placing orders and should verify that such information is current and complete. All products are sold subject to TI's terms and conditions of sale supplied at the time of order acknowledgment.

TI warrants performance of its hardware products to the specifications applicable at the time of sale in accordance with TI's standard warranty. Testing and other quality control techniques are used to the extent TI deems necessary to support this warranty. Except where mandated by government requirements, testing of all parameters of each product is not necessarily performed.

TI assumes no liability for applications assistance or customer product design. Customers are responsible for their products and applications using TI components. To minimize the risks associated with customer products and applications, customers should provide adequate design and operating safeguards.

TI does not warrant or represent that any license, either express or implied, is granted under any TI patent right, copyright, mask work right, or other TI intellectual property right relating to any combination, machine, or process in which TI products or services are used. Information published by TI regarding third-party products or services does not constitute a license from TI to use such products or services or a warranty or endorsement thereof. Use of such information may require a license from a third party under the patents or other intellectual property of the third party, or a license from TI under the patents or other intellectual property of TI.

Reproduction of information in TI data books or data sheets is permissible only if reproduction is without alteration and is accompanied by all associated warranties, conditions, limitations, and notices. Reproduction of this information with alteration is an unfair and deceptive business practice. TI is not responsible or liable for such altered documentation.

Resale of TI products or services with statements different from or beyond the parameters stated by TI for that product or service voids all express and any implied warranties for the associated TI product or service and is an unfair and deceptive business practice. TI is not responsible or liable for any such statements.

Mailing Address:

Texas Instruments
Post Office Box 655303
Dallas, Texas 75265