

Short description of the product

The Akyga® AK-L1-075 is a 75W power supply for industrial automation systems, machine control and lighting based on LED technology, which is used in powering LED strips, LED bulbs, LED panels, RGB LED drivers and other electronic equipment powered with 11 - 15V DC, which is regulated by a potentiometer. A set of protectors OVP, OTP, OPP, SCP, OCP provides safe and stable work of both power supply and powered device.

The product is adapted to supply voltage in the range of 110-265V, 50/60Hz.
The power consumption of powering device can not exceed the power supply nominal current.

The product is compatible with the applicable national and European requirements.

What is in the box?

- AK-L1-075 power supply
- Short user manual

Symbols explanation:

 There is a particular danger connected with service.

 There is a risk of losing health or life (e.g. by electric shock).

 Important tips and information.

 The CE standard description on the product is the manufacturer's declaration that the marked product meets the requirements of the directive so-called The "New Approach" of the European Union (EU). For security and certification (CE) reasons, the device can not be rebuilt or changed in any way. In the reason of using the power supply for other purposes than those described, the product may be damaged. The incorrect use may also cause hazard such as short-circuits, burns, electric shocks, etc. Read the user manual carefully and keep it for later use. The product could be shared to third parties only with the user manual included.

 Product accordance with the EU directive 2002/96/EC. The symbol of the crossed out basket placed on the product means that the marked product can not be disposed of with other household waste. After use, the product must be returned to collection point for used electrical and electronic equipment or to the seller. Appropriate segregation of rubbish for subsequent processing, recovery or destruction contributes to avoiding negative effects on the environment and health, and also allows the recovery of raw materials from which the product is made.

 The RoHS mark on the product is the manufacturer's declaration that the marked product meets the requirements of the EU Restriction of Hazardous Substances (2002/95/EC) directive, which aims to reduce the amount of hazardous substances penetrating into the environment from electrical and electronic waste.



The II protection class device. It provides protection against electric shock against direct and indirect contact, and thanks to the additional isolation it is not necessary to connect the device case with the protective earth conductor.



The device is intended only for domestic use, indoors.

Safety Precautions



WARNING! Product heats up during operation. To reduce the risk of burns or overheating the power supply, do not place it in restricted ventilation area. Also, do not allow the working power supply to touch soft surface such as pillows, blankets or clothing. The power supplies meets the limits on the surface temperatures available to the user, as defined in the International Standard for Safety of Information Technology Equipment (IEC 60950).



Connecting LED strips or other device whose demanded power is greater than power of the power supply, can cause battery failure or even damage (burn) of power supply.



An electrostatic discharge occurs when two objects touch each other, for example, an electric charge that occurs when a user touches a metal door handle after walking on a carpet. Discharging electrostatic charges from fingers or other electrostatic conductors can damage electronic components. To avoid damaging the computer, abstain from touching electrical outlets, wires and electronic circuits. The user's contact with electronic components should be kept to a minimum.



The manufacturer of the product is not responsible for damage or insults caused in effect of disobeying the safety instructions and information contained in this user manual.



- Keep the product and the packaging out of range of children and animals. The package includes a foil that a child could choke while playing.
- It is forbidden to apply mechanical load to the product - strong shocks, impacts, dropping or crushing may cause its damage.
- The product operation in adverse conditions is not allowed. Adverse conditions are primarily: exposure to direct sunlight, high or very low ambient temperatures, strong vibrations, high humidity, surroundings of gases, dusts or flammable and aggressive liquids.
- If the product has been damaged, does not work properly or has been stored for a long period of time in bad or unfavorable conditions, safe operation of the device is not possible. It is essential to stop using the product and to protect it against re-use for security purposes.
- Take account of the user manual for other devices connected to the LED power supply.
- Product and power cord should not be touched with moist or wet hands under no circumstances.
- Short-circuiting the current connection is prohibited.
- It is forbidden to put objects inside the housing.
- Make sure that the power cord is not crushed, bent, twisted, rubbed against sharp edges or mechanically loaded in any other way. Avoid thermal load of the cable - in particular keep away from heat sources (such as stoves, radiators, fireplaces).
- Power cords should be laid in such a way as to eliminate the risk of stumbling or hooking over.
- Connection of power supply to electricity is made by connecting it to the AC phase conductor.
- Before connecting the power supply to the phase conductor (cable is not included), make sure that the voltage specified on the power supply matches voltage supplied to the electrical connection.
- Before connecting the power supply / LED strips (or other devices) or conservation of the power supply make sure that the power cords are not live.



• In case of any doubts regarding operation, safety or connection of the product, please contact the manufacturer or a qualified specialist for this purpose.



• All maintenance, adjustment and repair work on the product may only be carried out by a qualified person in a specialist facility.

Removing the most common problems

Problem	Cause	Solution
The LED strip or other device connected via power supply does not work	No mains voltage	<ul style="list-style-type: none"> • Check the correct connection of the power supply to the energy grid • Check the mains fuses
	The power adapter is overloaded	<ul style="list-style-type: none"> • Disconnect the power adapter from energy grid, check the correctness of the current parameters
	Incorrect connection of the device	<ul style="list-style-type: none"> • Make sure that the power supply is correctly connected to the power grid • Check that the cords are well embedded in the connectors
	There is a suspicion of a product defect	<ul style="list-style-type: none"> • Stop using and contact the seller
The LED strip lights poorly	The power adapter does not correspond to the current parameters	<ul style="list-style-type: none"> • Check corresponds of the power of the LED strip to the power supply

LED Power Supply

How to choose the LED power supply correctly?

In order to properly match the power supply with the LED strip, multiply the length of the strip expressed in meters by the power of the tape, and then select the power supply with a margin of min. 10% to guarantee long and trouble-free system operation, unless the manufacturer of the LED strip recommends otherwise.

Connecting the LED Strip to the Power Supply:

1. If LED strip doesn't have attached locking connectors prepare 0.5 mm² cables or special LED connectors with cables.
2. Solder cables to LED strip or attach special LED connector on LED strip in the points intended for this.
3. Screw the cables from the LED strip to the LED power supply using the COM (pin 4, 5) and + V (pin 6, 7) screw connectors according to the polarity.
4. **WARNING!** For larger LED lighting installations, it is recommended to divide the strip into smaller sections.
5. The LED strip in RGB version needs RGB controller.

Connecting the Power Supply to energy grid:

1. Prepare the 3-wire power cable. **WARNING!** Make sure that the cables are not live.
2. Remove the insulation from the ends of the cables (about 0.5 cm).
3. Screw the cables: phase conductor (brown) to L connector, neutral conductor (blue) to N connector, protective conductor (yellow-green) to FG / .
4. Turn on the power.

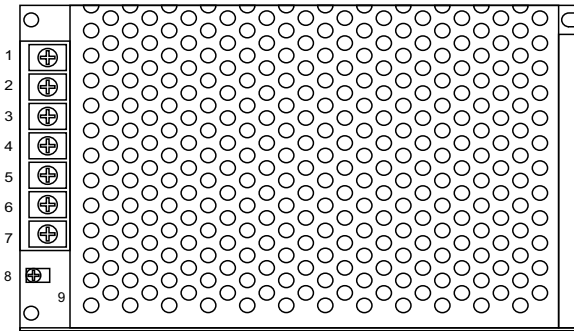

1. Phase conductor connector (L).
2. Neutral conductor connector (N).
3. Protective conductor connector (.
4. Output connector from the power supply (COM).
5. Output connector from the power supply (COM).
6. Output connector from the power supply (-V).
7. Output connector from the power supply (+V).
8. Potentiometer for changing the output voltage (+V ADJ).
9. LED diode indicating that the power supply is on.

Cleaning the power supply:



Disconnect the power supply from the electrical socket and connected devices before cleaning.



- Use soft and antistatic cloth for cleaning the power supply.
- Do not use abrasive or chemical cleaners.

Technical specification



Product code:	AK-L1-075
Supply voltage:	110-265V , 50/60Hz
Output voltage and amperage:	12V / 6.25A
Maximum power:	75W
Voltage adjustment:	11-15 V
Efficiency:	80%
Temperature:	5-50°C
Storage temperature:	-40/+80°C
OVP (over voltage protection):	Yes
OCP (over current protection):	Yes
OPP (overpower protection):	Yes
OTP (over temperaturre protection):	Yes
SCP (short circuit protection):	Yes
Power supply connector:	Screw
Output connector:	Screw
IP Rating:	IP20
Compliance with standards:	CE, FCC, RoHS
REACH compatibility:	YES
EAN code:	5901720134998

Product manufacturer:

Akyga Europe sp. z o.o.
ul. Wrocławska 1c
52-200 Suchy Dwór