

UNI-T®



UT139A/B/C

Operating Manual



True RMS Digital Multimeters



P/N: 110401104116X
MAY.2018 REV. 1

Table of Contents

I. Overview	1
II. Accessory	1
III. Safety Operation Regulation	1
IV. Electric Symbol	2
V. Comprehensive Specification	3
VI. Appearance Structure	4
VII. LCD Display	5
VIII. Knobs and Keys for Range Selection	7
IX. Measurement Instruction	9
X. Technical Index	16
XI. Upkeep and Maintenance	22

I. Overview

UT139A/B/C DMM is a small auto range, hand-held 3 1/2~3 5/6 bit true RMS multimeter featuring complete function, novel structure, high reliability and safety as well as large screen for display . It can be used for measuring AC/DC voltage and current, variable frequency voltage (V.F.C), resistance, diode, circuit on-off, capacitance, frequency ratio, NCV non-contact AC voltage sensing and so on, is an ideal portable maintenance instrument for users.

II. Accessory

Unpack and take out the instrument, please check following attachments carefully for completeness or intactness. In case of any shortage or damage, please contact with your supplier.

1. An operating instruction manual
2. A test pen (CAT III 600V)10 A
3. Point-type K(nickel chromium~nickel silicon) thermocouple (UT139C only)
4. An optional current clamp (UT139C only)

III. Safety Information

UT139A/B/C is designed in compliance with standards such as IEC/EN61010-1, pollution grade II, overvoltage (CATIII600V) and double insulation standards. Please comply with operation instruction specified in the Manual; otherwise the protection provided by the instrument may be affected.

CE:This Meter complies with the standards EN 61010-1,EN 61010-2-030: in pollution degree 2, overvoltage category (CAT III 600V) and double insulation.











ETL/cETL: CONFORMS TO UL STD 61010-1, 61010-2-030

CERTIFIED TO CSA STD C22.2 No. 61010-1, 61010-2-030

1. It is forbidden to use the product without having rear cap in place, or otherwise there will be electric shocking.
2. Prior to use, inspect the insulation layer of test pen for intactness, confirming no breakage and broken line.
3. When LCD display shows the icon “”, it is required to replace the battery in time to ensure the measurement accuracy.

4. Range switch shall be set at the correct measurement position.
5. In case of electric shock and damage to the instrument, signals being measured shall not exceed rated limit value.
6. To prevent any damage to the instrument, it is forbidden to change the gear of range switch in measurement.
7. After each measurement, disconnect table pen and the circuit being measured; after the current measurement, especially the measurement of large current, it is necessary to power off before disconnecting table pen and the circuit being measured.
8. In case of electric shock, it is required to be cautious when voltage being measured higher than DC 60V or AC 30Vrms.
9. Do not use the product in high-temperature or high-humidity environment, particularly in the damp environment in where the instrument performance may be severely degraded
10. Refrain from changing the internal wiring in the clamp ammeter to guard against damage to the meter and danger.
11. Clean the meter case with damp cloth and mild detergent rather than the abrasive material and solvent.

IV. Electric Symbol

	Low electricity of internal battery
	Buzzing On-off
	Diode
	AC/DC
	Warning
	Battery to be measured
	Grounding
	Current clamp
	Double Insulation
	Comply with European Union directive
	This symbol signify the product comply with both USA and Canada requirement

V. Comprehensive Specification

- Maximum voltage between input terminal and grounding: see instruction about each input terminal protection voltage.
- 10A terminal (CE) is equipped with:
F 10A H 600V fast-acting fuse (Φ6x25) mm
- mA/μA terminal (CE) is equipped with:
UT139A-FF 0.2A H 600V fast-acting fuse (Φ6x32) mm
UT139B-FF 0.5A H 600V fast-acting fuse (Φ6x32) mm
UT139C-FF 0.6A H 600V fast-acting fuse (Φ6x32) mm
- Maximum display: (UT139A): 1999; (UT139B): 4000; (UT139C): 6000 Refresh 2~3 times per second, display "OL" in case of overrange .
Capacitance and frequency (only applicable for UT139B/C): 9999 count.
Duty ratio (only applicable for UT139B/C): 1~99.9%
Diode: about 2.1V (UT139A) and 3.2V(UT139B/C), displaying "OL" in case of overrange.
Range: auto/manual
Polarity: auto
Working temperature: 0℃~40℃
Relative humidity: ≤75% when 0℃~30℃, and ≤50% when 30℃~40℃
Storage temperature: -10℃~50℃
- Electromagnetic compatibility:
In 1V/m radio frequency (RF) field: Overall accuracy=specified accuracy + 5% of range, and no specified index for RF over 1V/m.
- Operating ASL: 0~2000m
- Internal battery: AA R6P 1.5V×2
- Low electricity: LCD displays "".
- Contour dimension: about (175×80×48.5) mm
- Weight: about 350g (inclusive of battery)
- Safety Standard: IEC/EN 61010-1: CATIII/600V; Pollution grade II
- Accreditation: CE

VI. Appearance Structure (See Figure 1)

- Case
- LCD Display
- 3/4/7.: Selection buttons
5. Range Switch
6. Measuring input terminal

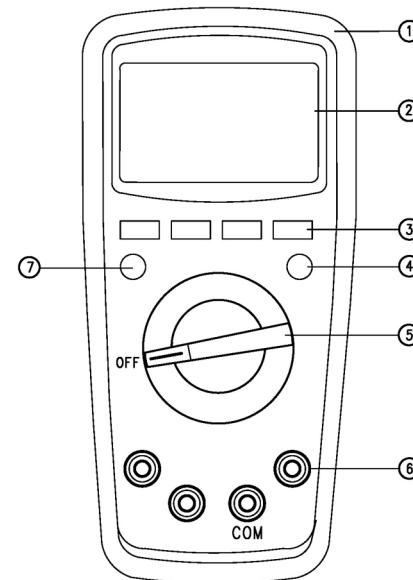
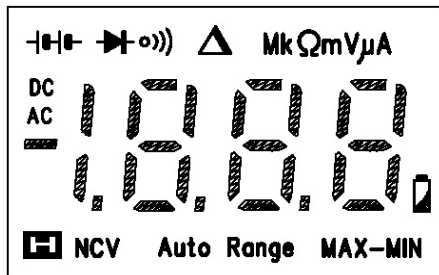

Figure 1

VII. LCD Display (See Figure 2)

139A-LCD:



139B/C-LCD:

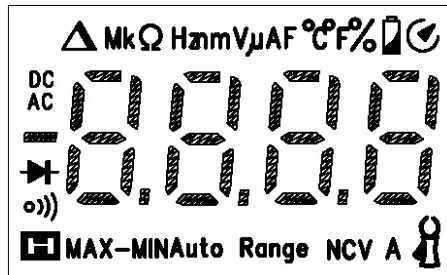

	Symbol	Instruction
1		Data hold prompt
2		Negative reading
3	AC/DC	AC/DC measurement prompt
4	MAX-MIN	Maximum/Minimum/Maximum-Minimum value measurement prompt
5		Under-voltage internal battery
6	Auto Range	Automatic range prompt

7		Diode measurement prompt
8		Circuit on-off measurement prompt
9		Relative measurement prompt
10	Ω/kΩ/MΩ	Resistance units: Ohm, Kilohm and Megohm
11	Hz/kHz/MHz	frequency units: Hz, kHz, MHz
12	%	Duty ratio measurement unit
13	mV/V	Voltage units: mV, V
14	μA/mA/A	Current units: μA, mA, A
15	nF/μF/mF	Capacitance units: nF, μF, mF
16	°C	Centigrade temperature unit
17	°F	Fahrenheit temperature unit
18	(EF)NCV	Non-contact AC voltage sensing
19		Auto power-off prompt
20		Current clamp