

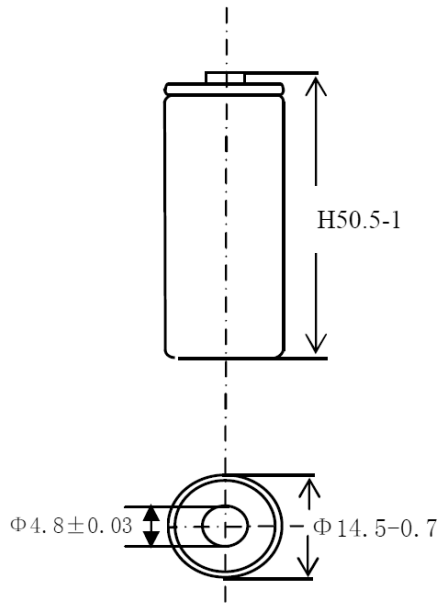

## Ni-MH "Ready to Use" Rechargeable Battery R6 AA 2000 mAh



<b>Designation IEC:</b>	HRL6
<b>Nominal voltage:</b>	1.2V
<b>Designed capacity:</b>	2000 mAh
<b>Typical capacity:</b>	1900 mAh (IEC 61951-2, 7.3.2)
<b>Cycle life:</b>	>700 according to IEC standard
<b>Standard charge:</b>	190 mA / 16 h
<b>Internal impedance:</b>	≤35 mΩ (fully charged)
<b>Weight:</b>	27 g
<b>Dimensions:</b>	50.5 x 14.5 mm
<b>Temperature ranges:</b>	long-term storage: -20..35°C application/discharge: -20..50°C charge: 0..45°C

### Discharge characteristics (load 0.2C – 380 mA):

Voltage (V)

