

SHA852A

SHA851A

Spectrum Analyzer

User Manual

EN_01A

Copyright and Declaration

Copyright

SIGLENT TECHNOLOGIES CO., LTD. All Rights Reserved.

Trademark Information

SIGLENT is the registered trademark of **SIGLENT TECHNOLOGIES CO., LTD.**

Declaration

- **SIGLENT** products are protected by patent law in and outside of P.R.C.
- **SIGLENT** reserves the right to modify or change parts of or all the specifications or pricing policies at company's sole decision.
- Information in this publication replaces all previously corresponding material.
- Any way of copying, extracting or translating the contents of this manual is not allowed without the permission of **SIGLENT**.

Product Certification

SIGLENT guarantees this product conforms to the national and industrial stands in China and other international stands conformance certification is in progress.

Contact Us

If you have any problem or requirement when using our products, please contact **SIGLENT TECHNOLOGIES CO., LTD**

Add : Blog No.4 & No.5, Antongda Industrial Zone, 3rd Liuxian Road, Bao'an District, Shenzhen, 518101, China

Tel : 400-878-0807

E-mail : sales@siglent.com

<http://www.siglent.com>

General Safety Summary

Carefully read the following safety precautions to avoid any personal injury or damage the instrument and avoid any products connected to it. To avoid potential hazards, please use the instrument as specified.

Protection is impaired if used in a manner not specified by the manufacturer.

Precautions for Operation

Before operating this product, special training is required to ensure that the user is physically, mentally and emotionally healthy and able to use the spectrum & network analyzer, otherwise it may cause personal injury or material damage. Employers, operators are responsible for selecting suitable personnel to operate this product.

Before moving or transporting this product. Please read and observe the "Safety Transportation Matters" chapter.









As with all industrial products, the use of substances that cause allergic reactions such as nickel cannot generally be ruled out. If you experience an allergic reaction while using this product, please consult a doctor in time to determine the cause.

Before you perform mechanical or heat treatment or disassemble the spectrum & network analyzer, please be sure to read and pay special attention to the "Waste Disposal/Environmental Protection" chapter.

In the event of a fire, this product may release harmful substances (gas, liquids, etc.), causing health problems. Therefore, appropriate measures must be taken, for example, protective masks and protective clothing must be worn.

Safety Terms and Symbols

The meaning of symbols

symbol	meaning	symbol	meaning
	Warning		Power Switch
	Hazardous Voltage		Equipment meeting double insulation or reinforced insulation
	EarthGround		Indoor use only
	Lithium battery failure		EU label for separately recycled electrical and electronic equipment

Cue and its meaning

DANGER : Indicates direct injury or hazards that may happen.

WARNING : Indicates potential injury or hazards that may happen.

CAUTION : Indicates potential damage to the instrument or other property that may happen.

It must be consulted in all cases where  is marked, in order to find out the nature of the potential HAZARDS and any actions which have to be taken to avoid them.

Cue et sa signification

DANGER : Indique des blessures directes ou des dangers qui peuvent survenir.

WARNING : indique des blessures ou des dangers potentiels pouvant survenir.

CAUTION : indique des dommages potentiels à l'instrument ou à d'autres biens pouvant survenir.

Il doit être consulté dans tous les cas où  est marqué, afin de connaître la nature des DANGERS potentiels et les actions à entreprendre pour les éviter.

Safety Operation Matters

The product can only be operated under the safe conditions and positions specified by the manufacturer. Do not obstruct the ventilation of the spectrum & network analyzer during use. Failure to comply with the manufacturer's specifications may result in electric shock, fire, serious personal injury, or even death. Applicable local safety regulations and accident prevention rules must be observed in all applications.

When powered by a power adapter, it can only be used indoors.

Do not place the product on surface, vehicle, cabinet or tables that for reasons of weight or stability are unsuitable for this purpose. When installing the product and fastening it to the article or structures, always follow the manufacturer's installation instructions. If the installation is not carried out in accordance with the requirements of the document, it may cause personal injury or even death.

Do not use this product in or near a heat source, and the ambient temperature cannot exceed the maximum temperature in the document or datasheet

Safety of Electricity

If you ignore the electrical safety methods, electric shock, fire and/or serious personal injury or death may occur.

Only use the power adapter and battery specified by the manufacturer to power the spectrum & network analyzer, and the power adapter can only work within its rated input voltage range.

Only the probe specified by the manufacturer can be used for testing. The use of non-manufacturer probes for testing may result in electric shock accidents.

The user is not allowed to damage the insulation protection layer of the spectrum & network analyzer and accessories. Doing so may cause electric shock. If an extension cord or terminal block is used for power supply, it must be checked regularly to ensure safe use.

Before use, please check whether the power cord and probe are damaged. If the power cord and probe are damaged, please do not continue to use the product.

Do not insert the AC plug of the power adapter into a dusty or dirty socket. Please make sure that the plug is firmly inserted into the socket, otherwise it may cause fire and/or injury due to sparks.

Do not overload any sockets, extension cords or connectors. Doing so may cause fire or electric shock.

When the measured voltage V_{rms} exceeds 30V, you should take appropriate measurement methods to avoid any danger.

Unless expressly permitted, do not remove the cover or any part of the shell while the product is in operation. Doing so will expose circuits and components, reduce the overvoltage level of the measurement, and may cause personal injury, fire, or damage to the spectrum & network analyzer.

Anything that is not designed to be placed on the external interface of this product should not be placed on the external interface, otherwise it will cause an internal short circuit and/or electric shock, fire or injury to the spectrum & network analyzer.

Do not place this product in an environment exceeding IP51, otherwise the spectrum & network analyzer will be damaged.

This product must be used in a dry environment, otherwise it may cause electric shock.

It is forbidden to use this product when condensation has formed or may form inside or on the surface of this product. For example, when the spectrum & network analyzer moves from a cold environment to a warm environment, the penetration of water increases the risk of electric shock.

Safety Transportation Matters

SIGLENT Technology provides handbags for the spectrum & network analyzer. For short-distance transportation under supervision, please make sure that the spectrum & network analyzer is turned off before putting it in the handbag. For long-distance transportation under unsupervised, please take out the battery and put it in your handbag.

In order to facilitate the user to hold, SIGLENT Technology has installed a fabric handle on the spectrum & network analyzer. This handle cannot be used as a focus point to be fixed on transportation equipment, such as cranes, forklifts, trucks, etc. It is the user's responsibility to fasten the product firmly to the transportation or lifting tool.

If you use this product in a vehicle, the driver is responsible for driving the vehicle safely and correctly. The manufacturer is not responsible for any accidents or collisions. Do not use this product in a moving vehicle to avoid distracting the driver. Use this product appropriately in the vehicle to prevent injury or other damage in the event of an accident.

Battery Usage

This product contains a rechargeable lithium battery pack. If misused, there is a risk of explosion, fire and / or serious personal injury, and even death in some cases.

The battery cannot be disassembled or crushed.

The battery or battery pack cannot be exposed to high temperature or fire, and it must be stored in direct sunlight. Keep the battery clean and dry. Use a dry, clean cloth to clean contaminated connectors.

The battery or battery pack cannot be short-circuited. Batteries or battery packs should not be stored in an environment that can easily cause a short circuit, such as boxes and drawers containing metal debris. The battery pack cannot be taken out of its original packaging before use.

Batteries and battery packs should not be exposed to any mechanical shock that exceeds the allowable level.

If the battery leaks, do not let the liquid contact the skin or eyes. If contact occurs, wash the contact

area with plenty of water and seek medical assistance.

The power adapter specified by SIGLENT Technology must be used for charging, otherwise it may cause a fire or cause personal injury or death.

It must be charged in a well-ventilated room. During the charging process, the spectrum & network analyzer should not be covered by objects (such as blankets, towels, clothes), which will affect the heat dissipation effect and cause a serious fire.

Improper battery replacement may cause an explosion. For the reliability and safety of the spectrum & network analyzer, the battery model specified by SIGLENT Technology must be replaced.

Used batteries and battery packs must be recycled and separated from residual waste. Batteries contain hazardous waste, and local regulations on waste disposal and recycling must be followed.

Waste Disposal

The used batteries in the product must not be disposed of together with unsorted municipal waste, they must be collected separately and placed in designated recycling points.

If the product and its components are mechanically and/or thermally processed in a way beyond the intended use, hazardous substances may be released. Therefore, this product can only be disassembled by professional personnel. Improper disassembly may endanger your health. The local waste disposal regulations must be followed.

Safety Compliance

This section lists the safety standards with which the product complies.

U.S. nationally recognized testing laboratory listing

- UL 61010-1:2012/R:2018-11. Safety Requirements for Electrical Equipment for Measurement, Control, and Laboratory Use – Part 1: General Requirements.
- UL 61010-2-030:2018. Safety Requirements for Electrical Equipment for Measurement, Control, and Laboratory Use – Part 2-030: Particular requirements for testing and measuring circuits.

Canadian certification

- CAN/CSA-C22.2 No. 61010-1:2012/A1:2018-11. Safety Requirements for Electrical Equipment for Measurement, Control, and Laboratory Use – Part 1: General Requirements.
- CAN/CSA-C22.2 No. 61010-2-030:2018. Safety Requirements for Electrical Equipment for Measurement, Control, and Laboratory Use – Part 2-030: Particular requirements for testing and measuring circuits.

General Care and Cleaning

Care

Do not store or leave the instrument in direct sunshine for extended periods of time.

To avoid damages to the instrument or probes, please do not expose them to fog, liquid, or solvents.

Cleaning

Please perform the following steps to clean the instrument and probes regularly in accordance with its operating conditions.

Disconnect the instrument from all power sources and then clean with a soft wet cloth.

Clean the loose dust on the outside of the instrument and probe with a soft cloth. When cleaning the LCD, take care to avoid scratching it.

To avoid damage to the surface of the instrument and probe, please do not use any corrosive liquid or chemical cleansers.

Make sure that the instrument is completely dry before restarting it to avoid potential short circuits or personal injury.

Measurement Category



WARNING

Make sure that no measurement overvoltage reach the product, or else the operator might expose to danger of electric shock.

Assurez-vous qu'aucune surtension de mesure n'atteigne le produit, sinon l'opérateur pourrait s'exposer à un risque de choc électrique.

IEC61010-2-030 defines the measurement category to rate the ability of measuring instruments to withstand short-term transient overvoltage outside of the working voltage. This product and its accessories can only be used in the environment of the nominal measurement category.

- CAT I :

0- An instrument with no rated measurement category is used to measure circuits that are not directly connected to the mains, such as a circuit board powered by a battery or a secondary circuit with special protection.

- CAT II:

For measurements installed in buildings, such as junction boxes, circuit breakers, distribution boards and equipment permanently connected to fixed installations.

- CAT III:

Used for measurements installed in buildings, such as junction boxes, circuit breakers, distribution boards and equipment that are permanently connected to fixed installations.

- CAT IV:

It is used for measuring at the source of low-voltage devices, such as electricity meters and primary overcurrent protection devices.

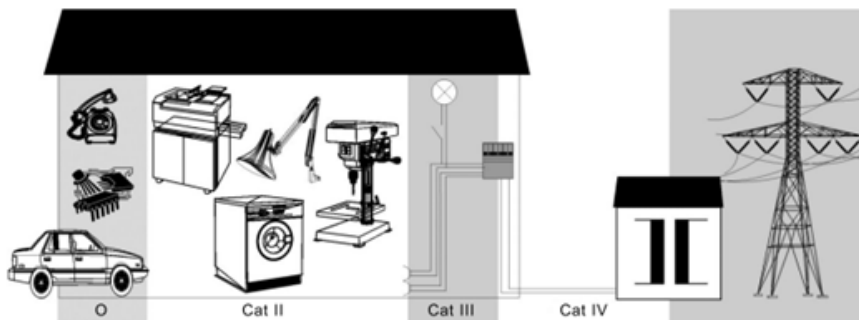

Working Environment

General requirement

Environment

This product is intended for indoor use and should be operated in a clean, dry environment.

It can be stored in an environment with a waterproof/dustproof rating better than IP51.

Temperature

Operating: 0°C to +40°C

Non-operation: -20°C to +60°C

Note: Direct sunlight, radiators, and other heat sources should be taken into account when assessing the ambient temperature.

Humidity

Operating: 85% RH, 40 °C, 24 hours

Non-operating: 85% RH, 65 °C, 24 hours

Altitude

Operating: less than 2 km

Non-operation: less than 3 km

Installation (overvoltage) Category

This product is powered by mains conforming to installation (overvoltage) category II.



WARNING

Make sure that no overvoltage (such as that caused by thunderbolt) can reach the product, or else the operator might expose to danger of electric shock.

Assurez-vous qu'aucune surtension (comme celle causée par la foudre) ne peut atteindre le produit, sinon l'opérateur pourrait s'exposer à un risque de choc électrique.

Installation (overvoltage) Category Definitions

Installation (overvoltage) category I refers to signal level which is applicable to equipment measurement terminals connected to the source circuit. In these terminals, precautions are done to limit the transient voltage to the corresponding low level.

Installation (overvoltage) category II refers to the local power distribution level which is applicable to equipment connected to the AC line (AC power).

Degree of Pollution

The spectrum & network analyzers may be operated in environments of Pollution Degree II.

Note: Degree of Pollution II refers to a working environment which is dry and non-conductive pollution occurs. Occasional temporary conductivity caused by condensation is expected.

IP Rating

IP51 (as defined in IEC 60529).

Ventilation Requirement

Please make sure that the air intake and exhaust areas are free from obstructions and have free air. When using the spectrum & network analyzer in a bench-top or rack setting, provide at least 10 cm clearance beside, above and behind the instrument for adequate ventilation.



WARNING

Inadequate ventilation may cause temperature increase which would damage the instrument. So please keep the instrument well ventilated during operation.

Une ventilation inadéquate peut entraîner une augmentation de la température qui endommagerait l'instrument. Veuillez donc garder l'instrument bien ventilé pendant le fonctionnement.

AC Power Requirement

The power adapter operates with a single-phase, 100 to 240 Vrms (+/-10%) AC power at 50/60 Hz (+/-5%).

No manual voltage selection is required because the instrument automatically adapts to line voltage.

Depending on the type and number of options and accessories (probes, PC port plug-in, charging etc.), When powered by adapter, the scope can consume up to 35 W of power.

Note: The power adapter automatically adapts to the AC line input within the following ranges:

Voltage Range:	90 - 264 Vrms
Frequency Range:	47 - 63 Hz

Please use the power cord and adapter provided by the manufacturer. Use of other non-designated products may cause personal injury.



WARNING

Electrical Shock Hazard!

Use of an adapter or power supply not specified by the manufacturer may cause personal injury.

Risque de choc électrique !

L'utilisation d'un adaptateur ou d'un bloc d'alimentation non spécifié par le fabricant peut entraîner des blessures.

To make the spectrum & network analyzer completely power off, unplug the instrument power cord from the AC socket and remove the battery from the scope.

The battery should be removed from the scope when it is not to be used for an extended period of time.

Maintenance and Services

Only authorized and specially trained personnel can open the spectrum & network analyzer. When performing maintenance operations on the spectrum & network analyzer, you must remove the power adapter and make sure that the spectrum & network analyzer is turned off, otherwise it may cause an internal short circuit of the spectrum & network analyzer.

Adjustment, replacement of parts, maintenance and repair can only be performed by operators authorized by SIGLENT Technology. Safety-related parts can only be replaced with original parts. Safety tests must be carried out after replacing part.

CONTENTS

COPYRIGHT AND DECLARATION	I
GENERAL SAFETY SUMMARY	II
PRECAUTIONS FOR OPERATION.....	II
SAFETY TERMS AND SYMBOLS	III
SAFETY OPERATION MATTERS	IV
SAFETY OF ELECTRICITY	IV
SAFETY TRANSPORTATION MATTERS	V
BATTERY USAGE	V
WASTE DISPOSAL	VII
SAFETY COMPLIANCE	VII
GENERAL CARE AND CLEANING	VIII
MEASUREMENT CATEGORY	IX
WORKING ENVIRONMENT	X
GENERAL REQUIREMENT	X
VENTILATION REQUIREMENT	XI
AC POWER REQUIREMENT.....	XII
MAINTENANCE AND SERVICES	XIII
CONTENTS	XIV
1 QUICK START	1
1.1 GENERAL INSPECTION	1
1.2 PREPARING FOR USE	2
1.2.1 <i>Appearance and Dimension</i>	2
1.2.2 <i>Power Supply Information</i>	3
1.3 FRONT PANEL	4
1.4 REAR PANEL.....	7
1.5 USER INTERFACE	10
1.6 TOUCH SCREEN AND MOUSE OPERATION.....	11
1.7 FIRMWARE OPERATION	12
1.7.1 <i>Check System Information</i>	12
1.7.2 <i>Load Option</i>	12
1.7.3 <i>Firmware Upgrade</i>	12

1.8	COMMUNICATION AND REMOTE CONTROL.....	12
1.9	SERVICE AND SUPPORT.....	13
1.10	TROUBLESHOOTING	13
2	MODE & MEASUREMENT	16
3	SPECTRUM ANALYZER MODE.....	19
3.1	FREQUENCY & SPAN	19
3.1.1	<i>Frequency & Span</i>	19
3.1.2	<i>X Axis Scale</i>	21
3.1.3	<i>Freq Offset</i>	21
3.1.4	<i>Freq Step</i>	21
3.1.5	<i>Auto Tune</i>	22
3.2	BW.....	22
3.2.1	<i>Resolution Bandwidth</i>	22
3.2.2	<i>Video Bandwidth</i>	23
3.2.3	<i>V/R Ratio</i>	24
3.3	SWEEP	25
3.3.1	<i>Sweep Points</i>	25
3.3.2	<i>Sweep Time & Sweep Time Rules</i>	25
3.3.3	<i>Sweep Time Estimate</i>	26
3.3.4	<i>Sweep/Measure</i>	27
3.4	AMPLITUDE	27
3.4.1	<i>Ref Level</i>	27
3.4.2	<i>Attenuator</i>	28
3.4.3	<i>RF Preamp</i>	29
3.4.4	<i>Ref Offset</i>	29
3.4.5	<i>Y Axis Scale</i>	29
3.4.6	<i>Correction</i>	31
3.5	TRIGGER.....	33
3.5.1	<i>Trigger Source</i>	33
3.5.2	<i>Trigger Level</i>	33
3.5.3	<i>Trigger Slope</i>	34
3.5.4	<i>Trigger Delay</i>	34
3.5.5	<i>Zero Span Trigger Delay Compensation (external trigger only)</i>	35

3.5.6	<i>Period (periodic trigger only)</i>	35
3.5.7	<i>Offset Time</i>	36
3.5.8	<i>Reset Time Offset Display</i>	36
3.5.9	<i>Sync Source (periodic trigger only)</i>	36
3.5.10	<i>Gate Source</i>	37
3.5.11	<i>Gate</i>	37
3.6	TRACE	41
3.6.1	<i>Select Trace</i>	41
3.6.2	<i>Trace Type</i>	42
3.6.3	<i>Trace State</i>	42
3.6.4	<i>Detect</i>	43
3.6.5	<i>Math</i>	44
3.6.6	<i>Normalize</i>	46
3.6.7	<i>Trace Function</i>	47
3.7	MARKER & PEAK	47
3.7.1	<i>Select Marker</i>	48
3.7.2	<i>Select Trace</i>	48
3.7.3	<i>Marker Type</i>	48
3.7.4	<i>Marker Postion</i>	50
3.7.5	<i>Relative To</i>	51
3.7.6	<i>Readout Type</i>	51
3.7.7	<i>Marker Couple</i>	52
3.7.8	<i>Marker Lines</i>	52
3.7.9	<i>Marker Table</i>	53
3.7.10	<i>Marker -></i>	53
3.7.11	<i>Marker Fn</i>	55
3.7.12	<i>Peak Search</i>	58
3.8	LIMIT.....	62
3.8.1	<i>Limit State</i>	62
3.8.2	<i>Limit Margin</i>	62
3.8.3	<i>Limit Type</i>	63
3.8.4	<i>Limit Edit</i>	63
3.8.5	<i>Limit Test</i>	66

3.8.6	Setup	67
3.9	MEAS & MEAS SETUP.....	67
3.9.1	Swept SA.....	68
3.9.2	Channel Power	73
3.9.3	ACPR.....	75
3.9.4	OBW	78
3.9.5	T-Power	81
3.9.6	TOI.....	83
3.9.7	Spectrum Monitor	84
3.9.8	CNR.....	86
3.9.9	Harmonics.....	88
3.9.11	IQ Acquisition	90
4	CABLE AND ANTENNA MODE.....	93
4.1	MEAS SETTINGS.....	93
4.1.1	Distance to Fault Measurement	93
4.1.2	Return Loss Measurements	95
4.1.3	1-Port Cable Loss Measurements.....	95
4.1.4	2-Port Insertion Loss Measurement.....	95
4.1.5	Time Domain Reflection Measurement.....	96
4.1.6	Output Power.....	99
4.2	FREQ/DIST.....	100
4.3	AMPLITUDE	101
4.3.1	Scale/Reference level and Position	101
4.3.2	Automatic Scaling.....	102
4.4	SWEEP	102
4.4.1	Points.....	102
4.4.2	Sweep Time.....	102
4.4.3	Sweep/Measure.....	103
4.5	AVERAGING.....	104
4.6	TRACE	104
4.6.1	Select Trace.....	104
4.6.2	Display Trace.....	105
4.6.3	Math.....	105

4.7	MARKER & PEAK.....	106
4.7.1	Marker Settings	106
4.7.2	Peak Search	109
4.7.3	Continue Peak/Valley	109
4.8	LIMIT.....	110
4.8.1	Limit Edit.....	110
4.8.2	Limit Test.....	113
4.9	CALIBRATION	114
4.9.1	Definitions.....	114
4.9.2	Calibration Kit	115
4.9.3	Calibration Type	116
4.9.4	Ecal.....	119
5	VECTOR NETWORK ANALYZER MODE	121
5.1	MEAS SETTING.....	121
5.1.1	Meas Type.....	121
5.1.2	Format	121
5.1.3	Output power	123
5.1.4	Port extention	124
5.2	FREQUENCE RANGE	125
5.3	BW.....	126
5.4	SWEEP	127
5.4.1	Points.....	127
5.4.2	Sweep Time &Sweep Time Rules.....	127
5.4.3	Sweep/Measure.....	127
5.5	AMPLITUDE	128
5.5.1	RF Atten.....	128
5.5.2	Y Axis.....	128
5.5.3	Auto Scaling.....	129
5.6	TRACE	130
5.6.1	Num of Traces.....	130
5.6.2	Select Trace.....	130
5.6.3	Memory Trace	131
5.6.4	Hold Trace	132

5.7	MARKER & PEAK.....	133
5.7.1	Marker Settings	133
5.7.2	Marker Function.....	135
5.7.3	Peak.....	138
5.8	LIMIT.....	139
5.8.1	Limit Edit.....	139
5.8.2	Limit Test.....	142
5.9	CAIBRATION	143
5.9.1	Definitions.....	143
5.9.2	Calibration Kit	144
5.9.3	Calibration Type	145
5.9.4	Ecal.....	148
6	MODULATION ANALYZER MODE	150
6.1	DIGITAL MODULATION ANALYSIS (DMA)	150
6.1.1	Settings.....	150
6.1.2	Demod	151
6.1.3	Filter.....	154
6.1.4	Burst/sync Search	155
6.1.5	BERT	158
6.2	ANALOG MODULATION ANALYSIS (AMA).....	159
6.2.1	Demod Type	159
6.2.2	IFBW.....	160
6.2.3	EqLPF.....	160
6.2.4	Average	160
6.3	FREQ.....	161
6.3.1	Freq & Span.....	161
6.3.2	CF Step.....	161
6.4	BW.....	162
6.4.1	EQBW.....	162
6.4.2	Window.....	162
6.5	SWEEP	163
6.5.1	Measure/Sweep Control (Single/Continue/Restart).....	163
6.6	TRIGGER.....	164

6.6.1	Trigger Source.....	164
6.6.2	Trigger Level.....	164
6.6.3	Trigger Slope.....	165
6.6.4	Trigger Delay.....	165
6.6.5	Zero Span Trigger Delay Compensation (External Trigger).....	166
6.6.6	Period(Period).....	166
6.6.7	Offset Time(Period).....	166
6.6.8	Reset Offset Display(Period).....	166
6.6.9	Sync Source(Period).....	167
6.6.10	Auto Trigger.....	167
6.6.11	Hold Off.....	168
6.7	AMPT.....	169
6.7.1	Attenuator & RF Preamp.....	169
6.7.2	Ref Level & Scale.....	170
6.8	TRACE.....	171
6.8.1	Select Trace.....	171
6.8.2	Layout.....	171
6.8.3	Trace Display and Layout (DMA).....	172
6.8.4	Trace Display and Layout (AMA).....	172
6.8.5	Select Trace.....	172
6.8.6	Num of Traces.....	172
6.8.7	Data.....	172
6.8.8	Format.....	173
6.8.9	Eye Length.....	173
6.8.10	Symbol Table.....	174
6.9	MARKER.....	174
6.9.1	Select Marker & Select Trace.....	174
6.9.2	Marker Type.....	174
6.9.3	Marker X.....	176
6.9.4	Reset Delta.....	176
6.9.5	Relative To.....	176
6.9.6	Marker Couple.....	177

7	INPUT AND OUTPUT	178
7.1	FREQ REF INPUT	178
7.2	INPUT Z CORRECTION	178
7.3	GPS	179
7.3.1	GPS Switch.....	179
7.3.2	Clock Synchronization Button	180
7.4	BIAS	180
7.4.1	Bias switch.....	180
7.4.2	Bias voltage	180
8	SYSTEM SETTINGS.....	181
8.1	SYSTEM	181
8.1.1	About	181
8.1.2	Hardware	182
8.1.3	Log Record	182
8.1.4	Language.....	182
8.1.5	Connect Setting.....	183
8.1.6	Date and Time	185
8.1.7	Option	185
8.1.8	Upgrade.....	185
8.2	RESET	186
8.2.1	Preset	186
8.2.2	Preset Type	186
8.2.3	Save User Config	186
8.2.4	Power On.....	186
8.2.5	Factory Reset	187
8.2.6	Reset&Clear	187
8.3	ALIGNMENTS	187
8.4	FILE	188
8.5	DISPLAY.....	189
8.6	POWER.....	190
8.7	SELF TEST	190
8.7.1	Screen Test	190
8.7.2	Keyboard Test	190

8.7.3	<i>LCD Test</i>	190
8.7.4	<i>Touch Test</i>	190
9	REMOTE CONTROL	191
9.1	REMOTELY OPERATING THE ANALYZER.....	191
9.1.1	<i>USB Device port</i>	191
9.1.2	<i>LAN port</i>	191
9.1.3	<i> GPIB-USB Host port</i>	192
9.2	BUILD COMMUNICATION.....	193
9.2.1	<i>VISA</i>	193
9.2.2	<i>Sockets/Telnet</i>	195
9.3	REMOTE CONTROL CAPABILITIES.....	195
9.3.1	<i>User-defined Programming</i>	195
9.3.2	<i>NI MAX</i>	196
9.3.3	<i>Web browser</i>	199
10	SCPI OVERVIEW	200
10.1	COMMAND FORMAT	200
10.2	SYMBOL INSTRUCTION.....	200
10.3	PARAMETER TYPE	201
10.4	COMMAND ABBREVIATION	202
10.5	IEEE COMMON COMMANDS	202
10.6	SCPI LIST.....	205
10.6.1	<i>GPSA</i>	205
10.6.2	<i>VNA</i>	209
10.6.3	<i>CAT</i>	212
10.6.4	<i>MA</i>	214
10.6.5	<i>Other</i>	216
11	SERVICE AND SUPPORT	217
11.1	SERVICE SUMMARY	217
11.2	TROUBLESHOOTING	217

1 Quick Start

This chapter guides users to quickly get familiar with the appearance, panel and the user interface, as well as announcements during the first use of the analyzer.

1.1 General Inspection

When you get a new analyzer, it is recommended that you proceed through the following steps.

Check to see if there is any damage caused by shipping problems

If the packing case or foam protective pad is seriously damaged, keep it until the whole machine and accessories pass the electrical and mechanical tests.

Inspection machine

If you notice external damage, contact your **SIGLENT** dealer or local office, and **SIGLENT** will arrange for a repair or replacement.

Check the accessories

Please check the accessories according to the packing list in the box. If the accessories are incomplete or damaged, please contact your **SIGLENT** sales representative.

1.2 Preparing for Use

1.2.1 Appearance and Dimension

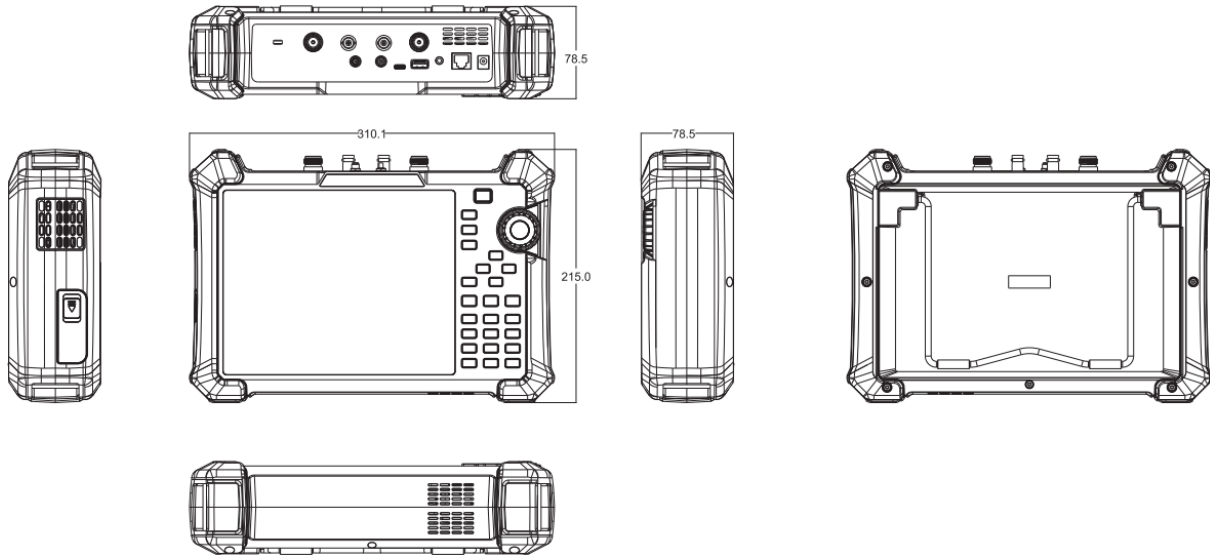

Unit:mm

Figure 1-1 Front and lateral View

The included tilting stand is available for desktop operation. The tilting bracket provides a backward tilt for improved stability. To deploy the tilt bracket, pull the bottom of the tilt bracket away from the back of the instrument. To retract the tilting bracket, push the bottom of the bracket toward the back of the instrument.



Figure 1-2 Side View

1.2.2 Power Supply Information

The battery that comes with the SHA800A may need to be recharged before use. The device can use the supplied AC-DC adapter (refer to the product technical data sheet for ordering information). The specifications of the input AC power supply are: 100-240V, 50/60Hz; Or charge through the on-board DC adapter in the accessory.

Specifically, the analyzer can be connected to the adapter according to the power socket shown in the figure below.

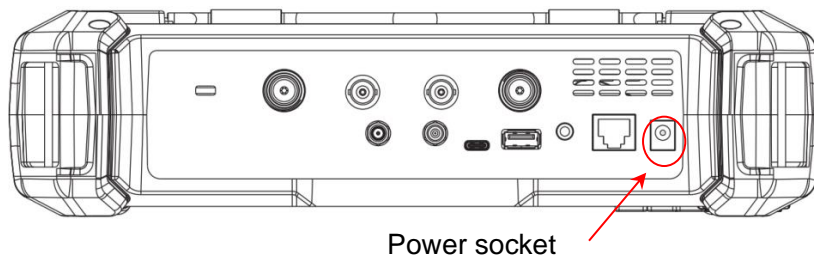

Figure 1-3 Rear View and Power

- ◆ Adapter factory configuration is the 12V 4A
- ◆ Battery factory installed, the user can change itself



WARNING

This instrument can only use Siglent approved batteries, adapters and chargers. When using an onboard DC adapter, always ensure that the power supply is rated at least 75 W @ 15 VDC and that there is no dust or debris on the socket. If the adapter plug becomes hot during operation, discontinue use immediately. Siglent recommends taking out the batteries when devices aren't used for too long.

1.3 Front Panel







Figure 1-4 the Front Panel

Table 1-1 Front Panel Description

NO.	Name	Description
1	LCD Screen	8.4 inch multi-touch screen, resolution 800*600
2	Power Switch	Stand by status: Orange Power on status: White Short press: To Stand by status with current state saved Long press: To Stand by status without current state saved
3	Function Keys	Complete the function control and parameter input of the analyzer, and most operations can be completed by the touch screen. Press Lock to turn off/on the keyboard and touch functions.
4	Three-dimensional knob	Complete the quick adjustment and selection of parameters.
5	Fan vent	Built-in fan external exhaust port. Please ensure that this vent is unblocked.
6	Battery case cover	Internal battery protection cover. Remove during battery replacement.
7	Detachable hand strap	Convenient hand force, can be installed on both sides.



Table 1-2 Shortcut Keys Description









Name	Description
	The menu selection window pops up on the screen, and you can use the touch screen control to directly enter a function menu.
	Shortcut screenshot button to save the current screen display as a picture. Save parameters, such as path, reverse color, and screenshot area, to be set in System > File.
	Measurement control, pause or resume the current measurement process. When the button light is on, the measurement is suspended. When the button light is off, the measurement is resumed.
	Key and touch screen lock control. When the button light is on, all key pad buttons and touch screen buttons except the Lock button are locked to prevent misoperation.



The function key part of the front panel is the reuse key of menu selection mode and value input mode, which can be switched by **Enter** and **Esc** :

- ◆ Under default reset, the operation interface is in menu selection mode, and function keys will be identified as the blue silk screen function identifier on the upper side of the key. Use **Enter** to switch from menu selection mode to value input mode.
- ◆ When the operation interface is in value input mode, the multiplex key will be identified as the white silk screen digital identifier inside the key. You can use **Esc** to switch from value input mode to menu selection mode.

Table 1-3 Function Keys Description

Name	Description
	Menu selection mode, to select the analyzer operation mode, such as spectrum analysis mode, antenna and cable test mode, network analyzer mode, etc.
	In menu selection mode, control of mode measurement parameters, such as average times, specific test items, etc.
	In menu selection mode, frequency parameters are controlled. In time domain analysis, length (distance) parameters are controlled.
	Menu selection mode, bandwidth class parameter control, such as RBW, VBW, IFBW and so on.
	In menu selection mode, control cursor Marker parameters, such as cursor type, cursor positioning, noise cursor, N dB bandwidth, etc.
	Menu selection mode, for amplitude class parameters control, such as scale and unit, as well as preattenuator, preamplifier, amplitude correction, etc.
	In the menu selection mode, control the scanning parameters, such as scanning time and type, scanning number, trigger, gating, etc.
	In the menu selection mode, control the peak parameters, such as peak search, peak rule setting, etc.
	In menu selection mode, trace parameters are controlled, such as trace state, detection, mathematical calculation, normalization, etc.
	In menu selection mode, control the parameters of limit line, such as limit line editing, margin, test state setting, etc.
	In menu selection mode, port calibration of antenna and cable test mode and network analysis mode is carried out, such as selecting the type of mechanical calibration part, user-defined calibration part parameters, loading electronic calibration part, etc.
	In menu selection mode, reset parameters can be controlled, such as reset status definition, power-on status definition, user status definition, etc.
	In the menu selection mode, you can perform file operations, such as saving and invoking files, and viewing file browsers.
	In menu selection mode, the system general information view, version and calibration operation, as well as input and output port Settings, screen display Settings, etc.

1.4 Rear Panel

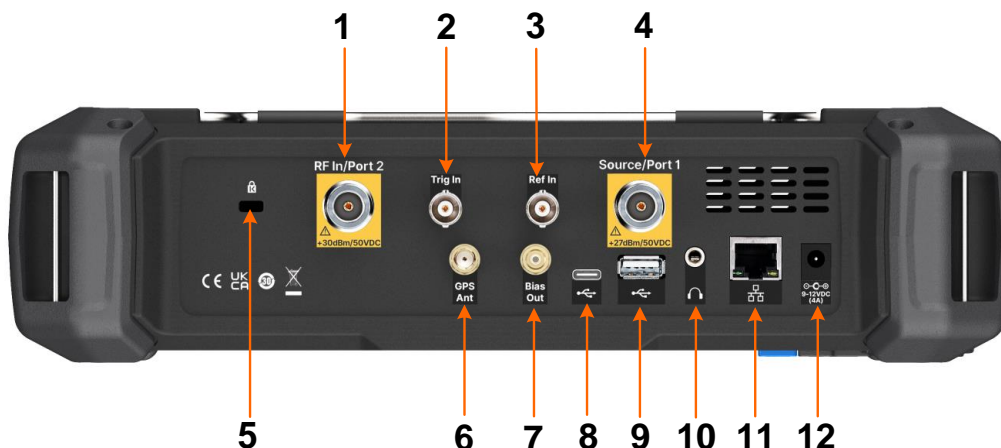



Figure 1-5 Rear Panel

Table 1-4 Rear Panel Description

NO.	Name	Description
1	RF In/Port 2	Signal input: 50Ω N female connector. Maximum input ±50 VDC, + 30 dBm.
2	Trig In	Trigger input is a BNC female connector. When the analyzer uses an external trigger mode, the connector receives a rising or falling edge of an external trigger signal that is used to establish event synchronization.
3	Ref In	Reference clock input, BNC female connector. The analyzer can use an internal reference clock or an external reference clock. If the instrument detects a signal from an external 10 MHz reference clock, it automatically uses the signal as the analyzer's reference clock source. At this time the screen status bar frequency reference display external; When the external 10 MHz reference signal is lost, exceeded, or not connected, the analyzer's reference clock is automatically switched to the internal 10 MHz reference clock, and the screen frequency reference bar will display the internal. [Ref In] is used to establish clock synchronization between multiple instruments.
4	Source/Port 1	The signal output and input terminals are 50Ω N female connectors. In spectrum analysis mode, signal output as an independent signal source. In the network analysis mode, as the excitation and receiving interface, this port built-in coupler, to achieve a single port vector network analysis function.
5	K-groove	Slots are provided to accept Kensington® cable locks.
6	GPS Ant	The GPS antenna port is a SMA female connector used to install the GPS antenna and receive GPS satellite signals. Can provide 3.3V DC feed for active GPS antenna.

7	Bias Out	The offset voltage output port is a 50Ω female SMB connector. Used to provide bias voltage for external signal amplifiers, such as tower amplifiers.
8	USB Device	The main USB port is TypeC. The analyzer can be used as a slave device and connected to a PC via USB cable. The PC uses the USB-TMC protocol to remotely control the analyzer.
9	USB Host	USB slave port, TypeB. The analyzer can be used as the main device and is connected to external USB devices through this port. For example, Connect external extended memory to read files in memory, or store the current instrument state, data, or current screen display content into memory; Connect a USB keyboard, USB mouse, or other USB receiver; Connect USB-GPIB adapter to realize GPIB remote control of analyzer; Connect electronic calibration parts to realize automatic calibration of analyzer.
10	Audio output	3.5mm headphone jack. The analyzer provides AM and FM demodulation functions. The headphone jack is used to insert the headphone to listen to the audio output of the demodulation signal. You can turn on or off the headset and adjust the volume of the headset through the menu.
11	LAN	RJ45 ports. The analyzer is connected to the LAN through network cable, and can be viewed and controlled remotely through VXI, Socket protocol, or a web browser.
12	External power supply	2.5mm x 5.5mm barrel connector, connected to 12V 4A power adapter charging port, center positive. Used to power devices and charge batteries.

	<p>WARNING</p> <p>The analyzer does not support DC input. To avoid damage to the instrument, the DC voltage component of the signal reaching the RF input must not exceed 50 V.</p> <p>If possible, add an isolated DC component to the RF input of the analyzer before signal measurement.</p>
---	--

	<p>WARNING</p> <p>In order to avoid damage to the instrument, the DC voltage component of the signal input to the RF input should not exceed 50 V;</p> <p>When the frequency is greater than 10 MHz, the maximum continuous power of the RF signal shall not exceed +33 dBm.</p> <p>When the frequency is less than 10 MHz, the maximum continuous power of the RF signal should not exceed +20 dBm.</p>
---	---

	<p>WARNING</p> <p>Before connecting any signal, short connect the inner core of the test cable to the housing floor to release the static electricity accumulated on the inner core of the test cable.</p>
---	---

1.5 User Interface

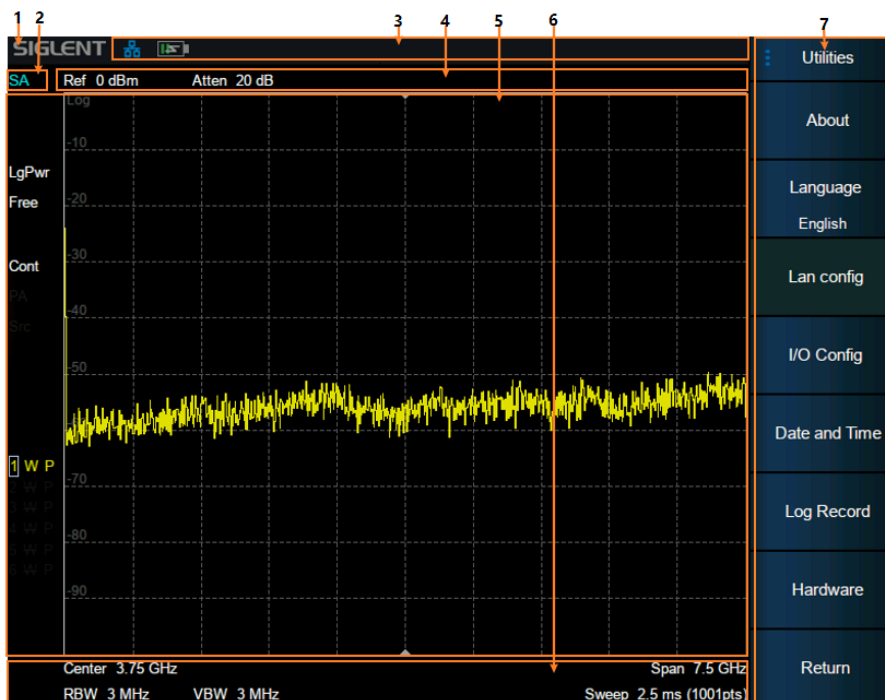

Figure 1-5 User Interface of spectrum analyzer mode

Table 1-5 Spectrum Analyzer Mode User Interface

No	Name	Description
1	SIGLENT	SIGLENT logo
2	Mode/Measure	Indicate the current working mode and measurement function of the analyzer, and click to switch, such as spectrum analysis mode, real-time spectrum mode, etc.
3	Hardware status bar	Indicates the status of hardware, interfaces, etc.
4	Measurement status bar	Indicates measurement status of reference level, attenuation, cursor, etc.
5	Result display area	The measurement results are displayed in various forms such as spectral lines, cursors, tables and constellation charts.
6	Scan parameter area	Indicates and controls major scan parameters.
7	Menu area	Used to configure measurement Settings.

1.6 Touch screen and mouse operation

The analyzer provides a 8.4 inch multi-touch screen and supports various gesture operations including:

- ◆ Slide the waveform left and right or up and down in the measurement result area to change the X-axis center coordinate or Y-axis reference coordinate. Perform two-points scaling in the waveform area to change the X-axis span
- ◆ The waveform is scaled horizontally at two points in the measurement result area to change the X-axis display range
- ◆ Click the shortcut menu area, working status area, scanning parameter area and menu area for function selection
- ◆ Click editable parameters, virtual numeric keyboard or QWERT keyboard will pop up, parameter or text editing
- ◆ Open and drag the cursor
- ◆ When the mouse is connected, clicking the left mouse button has the same effect as a single touch

You can turn the touch screen function on and off via **Lock** .

Table 1-6 Touch Operations

No	Name	Description
1	Click	Most controls just need to be tapped, touched and released.
2	Double click	Some controls require double clicking. If the second press is not detected within a specific time period, the operation is cancelled or treated as a single press.
3	Press and drag	Some objects can be dragged. This is done by gently holding down the action object and dragging it to a new position while releasing it. For example, you can drag items such as tags, limit line nodes, and center frequencies by dragging tracks left or right.
4	Pinch or release	Some projects can be scaled down or expanded. This is done by pressing down with two fingers at the same time and gently holding the item as you pull the fingers closer or further, then releasing. You can pull items in and out, such as frequency spans, by touching and holding the trace in two locations, then pulling your finger closer to narrow the span or pulling your finger further to widen it.

1.7 Firmware Operation

1.7.1 Check System Information

Users can get the system information by press **System** > “System” -> “About”, including

- Product Model, Serial and Host ID
- Software Version and hardware Version
- Option Information

1.7.2 Load Option

Refer to the procedures below to activate the options you have purchased.

- 1 Press **System** > “System”-> “Load Option”
- 2 Enter the license key in the onscreen window. Press **Enter** to confirm your input and terminate the license key input. Or
- 3 Load the .lic file provided by pressing **File** > “Load” from internal memory or USB stick.

The option will be enabled after rebooting.

1.7.3 Firmware Upgrade

Follow this procedure to update the instrument firmware:

1. Download the firmware package from an official SIGLENT website.
2. Extract and copy the .ADS file into the root directory of an USB stick.
3. Plug the USB stick into the USB Host connector. Press **System** > “System” -> “Update”; find the .ADS file in USB stick.
4. Press the “Load”, the analyzer will perform the update process automatically.



The upgrade process will take several minutes. When the upgrade is completed, the machine will reboot.
Any interruption during the update process will result in update failure and system data loss. This is **not covered under the warranty** and the user will bear repair costs and shipping.
Do not remove the USB storage device until the update is finished.

1.8 Communication and Remote Control

The analyzer supports communication with computers via USB, LAN, and GPIB-USB interfaces. By using these interfaces, in combination with programming languages and/or NI-VISA software, users can remotely control the analyzer based on a SCPI (Standard Commands for Programmable Instruments) compliant command set, LabView and IVI (Interchangeable Virtual Instrument), to

interoperate with other programmable instruments.

You can also go to **System** > System > Interface Settings > Web Services and set the corresponding communication port to view and control the analyzer directly on a PC or mobile terminal using a web browser. For more details, refer to the 'User Guide'.

1.9 Service and Support

SIGLENT warrants that the products that it manufactures and sells will be free from defects in materials and workmanship for a period of three years (accessories for a period of one year) from the date of shipment from an authorized Siglent distributor.

If the product proves defective within the respective period, SIGLENT will provide repair or replacement as described in the complete warranty statement. To arrange for service or obtain a copy of the complete warranty statement, please contact your nearest Siglent sales and service office. Except as provided in this summary or the applicable warranty statement, SIGLENT makes no warranty of any kind, express or implied, including without limitation the implied warranties of merchantability and fitness for a particular purpose. In no event shall SIGLENT be liable for indirect, special or consequential damages.

1.10 Troubleshooting

Troubleshoot the analyzer according to the following steps:

1. Switch on the power and the instrument will enter the charging state. The backlight of the power switch on the front panel will light up orange (charging)/green (full).

If the power switch on the front panel is not on:

- ◆ Check that the power switch is turned on and that the power connector is properly connected

2. Press the power switch on the front panel, and the instrument will turn on. The color of the power switch on the front panel will turn white. At the same time, the fan on the back will turn and the screen will light up.

If the instrument does not enter the power on state normally:

- ◆ Check whether the fan and screen are loose or damaged
- ◆ If the fan and screen are normally powered on, but the screen stops in the startup screen, or the button does not respond

If the above problems exist, do not disassemble the instrument and contact SIGLENT in time.

3. The analyzer enters the working state normally, and the buttons and touch screen should respond to the measurement operation normally.

If the instrument does not work properly:

- ◆ Check that the analyzer is working in the remote control lock state
- ◆ Check whether the analyzer can be controlled using the mouse and keyboard
- ◆ Check whether the analyzer can be controlled using VNC or remote commands
- ◆ Press **System** > **Self-Test** > Screen Test/Key Test /LED test/Touch test to check whether there is any response or interference between the key and screen
- ◆ Check whether strong electromagnetic fields exist around the analyzer. Strong electromagnetic fields will affect the response of the capacitor touch screen

If the above problems exist, do not disassemble the instrument and contact SIGLENT in time.

4. The analyzer should be in scanning or measuring state when working normally, and the screen waveform and parameters are in updating state.

If the instrument screen waveform or parameters are not updated for a long time:

- ◆ Check whether the current trace is in View state or multiple averaging state
- ◆ Check whether the trigger conditions are not met and wait. Check the trigger Settings and whether there is a trigger signal
- ◆ Check whether it is currently in a single scan state, or whether it is in a measurement calculation state
- ◆ Check whether the current scan time is set too long or whether the measured dwell time is set too long

5. Incorrect or inaccurate measurement:

Users can obtain detailed instructions on technical indicators from the back of this manual to calculate systematic errors, check measurement results and accuracy problems. To achieve the performance indicators listed in this manual, you need:

- ◆ The instrument is in the calibration cycle, stored in the working temperature of 20°C~30°C for at least two hours, and preheated for more than 40 minutes
- ◆ Have a certain understanding of the measured signal, and set the appropriate parameters for the instrument
- ◆ Check that external devices are properly connected and working, and that line losses are correctly compensated
- ◆ Check whether signal tracing, frequency offset, amplitude offset, or correction functions are applied
- ◆ Check whether an external reference clock source is applied
- ◆ The instrument is measured and calibrated regularly to compensate for measuring errors caused by aging and other factors. For calibration, contact SIGLENT, Inc., or an authorized measurement provider for paid service.

6. Pop-up message:

The instrument will give prompt message, error message or status message according to the state it is in. These messages can help the user to use the device correctly, not the device failure.

2 Mode & Measurement

The analyzer operates in multiple operating modes, each of which contains several measurements:

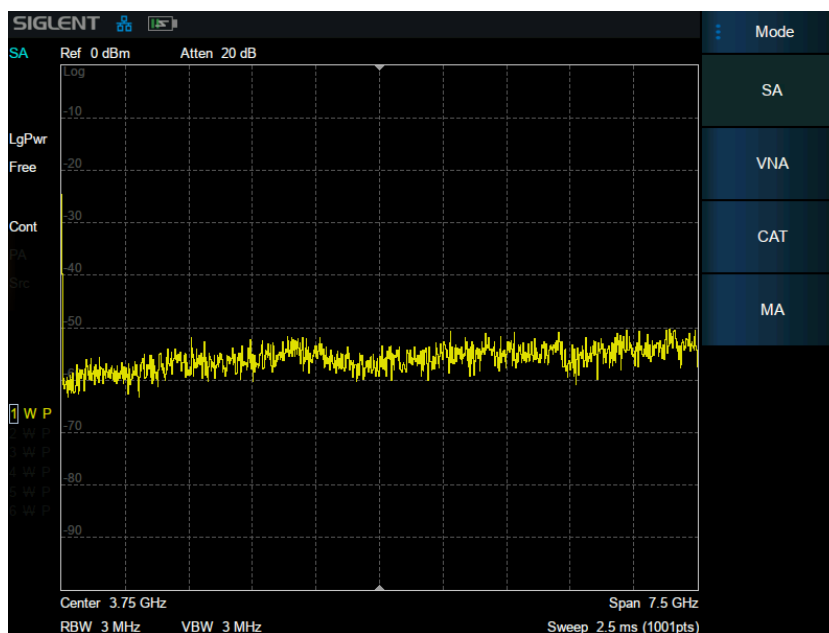

Figure 2-1 Mode selection

- Spectrum Analyzer Mode (GPSA)
- Cable and Antenna Mode (CAT)
- Vector Network Analyzer Mode (VNA)
- Modulation Analyzer Mode (MA)

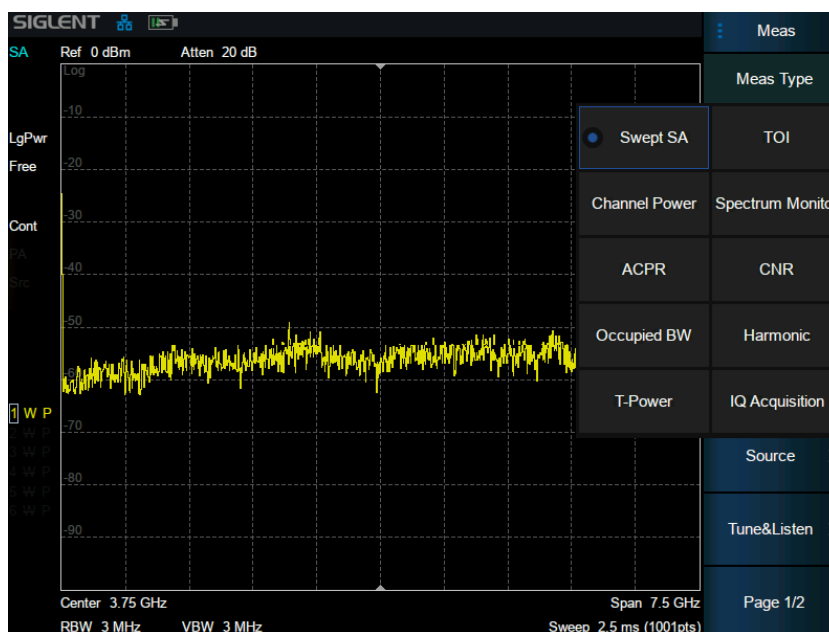

Figure 2-2 GPSA measurement selection

- **Spectrum Analyzer Mode(GPSA) :**
 - Swept Spectrum Analyzer (Swept SA)
 - Channel Power (CH Power)
 - Adjacent Channel Power Ratio (ACPR)
 - Occupied BW (OBW)
 - T-Power (T-Power)
 - Third Order Intercept (TOI)
 - Spectrum Monitor (Spectrum Monitor)
 - Carrier Noise Ratio (CNR)
 - Harmonic Analysis (Harmonic)
 - IQ Acquisition

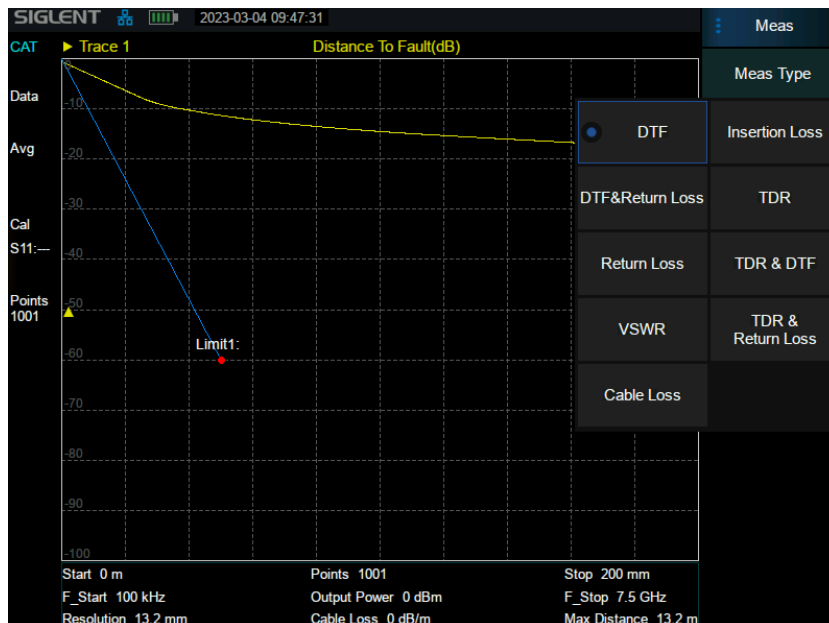

Figure 2-3 CAT measurement selection

- **Cable and Antenna Mode (CAT) :**
 - Distance to Fault
 - Return Loss
 - VSWR
 - Cable Loss
 - Insertion Loss
 - Time Domain Reflectometry
 - DTF&Return Loss

TDR&Return Loss

TDR&DTF

- **Vector Network Analyzer Mode (VNA)**

- **Modulation Analyzer Mode (MA) :**

Digital Modulation Analyzer (DMA)

Analog Modulation Analyzer (AMA)

The analyzer supports the creation of multiple independent modes / measurements, but only one of them can be activated at the same time. Wait until the next activation to restore the state before switching

Command Format	:INSTrument[:SElect] :INSTrument[:SElect]?
Instruction	Select the working mode of the spectrum analyzer.
Parameter Type	Enumeration
Parameter Range	SA: Spectrum Analysis Mode MA: Modulation Analysis RTSA: Real-Time Spectrum Analysis
Return	Enumeration
Example	:INSTrument MA

Command Format	:INSTrument:MEASure :INSTrument:MEASure?
Instruction	Get/Set the measurement mode.
Parameter Type	Enumeration
Parameter Range	SA: Spectrum Analysis ACPR: Adjacent Channel Power Ratio CHPower: Channel Power OBW: Occupy Bandwidth TPOWer: Time-Domain Power SPECtrogram: Spectrogram TOI: Third-Order Intermodulation HARMonics: Harmonic Analysis CNR: Carrier-to-Noise Ratio
Return	Enumeration: SA ACPR CHP OBW TPOW SPEC TOI HARM CNR
Example	:INSTrument:MEASure ACPR

3 Spectrum Analyzer Mode

The Spectrum Analyzer Mode is the default mode of the analyzer.

3.1 Frequency & Span

3.1.1 Frequency & Span

Set the frequency-related parameters and functions of the analyzer. The sweep will restart every time the frequency parameters are modified.

The frequency range of a channel can be expressed by these parameters: Start Frequency, Center Frequency, Stop Frequency and Span. If any of the parameters change, the others will be adjusted automatically in order to ensure the coupling relationship among them:

$$f_{\text{center}} = (f_{\text{start}} + f_{\text{stop}})/2$$

$$f_{\text{span}} = f_{\text{stop}} - f_{\text{start}}, \text{ Where } f_{\text{span}} \text{ is the span.}$$

The LO will sweep from the Start Frequency to the Stop Frequency if the Span > 0, while the LO is fixed at a constant frequency if Span = 0 (Zero Span).

Span change, associated with BW and scan parameters.

After the frequency related parameters are changed, restart scanning \ measurement.

Last sweep sets the sweep width to the value before the last modification.

Zoom in sets the sweep width to half the current sweep width value.

Zoom out sets the sweep width to twice the current sweep width value.

Command Format	[[:SENSE]:FREQUENCY:CENTER [:SENSE]:FREQUENCY:CENTER?
Instruction	Sets the center frequency of the spectrum analyzer. Gets the center frequency.
Parameter Type	Float, unit: Hz, kHz, MHz, GHz
Parameter Range	50 Hz~7.5 GHz Zero Span: 0 ~ 7.5 GHz
Return	Float, unit: Hz
Example	:FREQUENCY:CENTER 0.2 GHz

Command Format	[[:SENSE]:FREQUENCY:START [:SENSE]:FREQUENCY:START?
Instruction	Sets the start frequency of the spectrum analyzer. Gets the start Frequency.
Parameter Range	0 Hz ~ 7.5 GHz Zero Span: 0 ~ 7.5 GHz
Example	:FREQUENCY:START 100 Hz

Command Format	[[:SENSe]:FREQuency:STOP [:SENSe]:FREQuency:STOP?
Instruction	Sets the stop frequency of the spectrum analyzer. Gets the stop frequency.
Parameter Type	Float, unit: Hz, kHz, MHz, GHz
Parameter	100 Hz ~ 7.5 GHz
Range	Zero Span: 0 ~ 7.5 GHz
Return	Float, unit: Hz
Example	:FREQuency:STOP 1.0 GHz

Command Format	[[:SENSe]:FREQuency:SPAN [:SENSe]:FREQuency:SPAN?
Instruction	Sets the frequency span. Setting the span to 0 Hz puts the analyzer into zero span. Gets span value.
NOTE	Channel Power Only : [:SENSe]:CHPower:REQuency:SPAN OBW Only : [:SENSe]:OBWidth:REQuency:SPAN ACPR Only : [:SENSe]:ACPower:REQuency:SPAN TOI Only : [:SENSe]:TOI:REQuency:SPAN CNR Only : [:SENSe]:CNR:REQuency:SPAN
Parameter Type	Float, unit: Hz, kHz, MHz, GHz
Parameter Range	0 Hz, 100 Hz ~ 28GHz
Return	Float, unit: Hz
Example	:FREQuency:SPAN 1 GHz

Command Format	[[:SENSe]:FREQuency:SPAN:FULL
Instruction	Sets the frequency span to full scale.
Example	:FREQuency:SPAN:FULL

Command Format	[[:SENSe]:FREQuency:SPAN:ZERO
Instruction	Sets the frequency span to zero span.
Example	:FREQuency:SPAN:ZERO

Command Format	[[:SENSe]:FREQuency:SPAN:PREVious
Instruction	Sets the frequency span to the previous span setting.
Example	:FREQuency:SPAN:PREVious

Command Format	[[:SENSe]:FREQuency:SPAN:HALF
Instruction	Sets the frequency span to half of the current span setting.
Example	:FREQuency:SPAN:HALF

Command Format	[[:SENSe]:FREQuency:SPAN:DOUBle
Instruction	Sets the frequency span to double the current span setting.
Example	:FREQuency:SPAN:DOUBle

3.1.2 X Axis Scale

Set the scale type of X-axis to Linear (Lin) or Logarithmic (Log) scale.

In Log scale type, the frequency scale of X-axis is displayed in the logarithmic form.

Command Format	:DISPlay:WINDow:TRACe:X[:SCALe]:SPACing :DISPlay:WINDow:TRACe:X[:SCALe]:SPACing?
Instruction	Sets the The x type Gets the The x type
Parameter Type	enumeration
Return	LOG/LIN
Example	:DISPlay:WINDow:TRACe:X:SPACing LOG :DISPlay:WINDow:TRACe:X:SPACing?

3.1.3 Freq Offset

Set the frequency offset value to illustrate the frequency conversion between the measured device and the input of the spectrum analyzer.

- This parameter does not affect any hardware settings of the spectrum analyzer, but only changes the display values of center frequency, start frequency and stop frequency.
- To eliminate the frequency offset value, the frequency offset value can be set to 0 Hz.

Command Format	[:SENSe]:FREQUency:OFFSet [:SENSe]:FREQUency:OFFSet?
Instruction	Sets the frequency offset of the spectrum analyzer. Gets the frequency offset.
Parameter Type	Float, unit: Hz, kHz, MHz, GHz
Parameter Range	-100 GHz ~ 100 GHz
Return	Float, unit: Hz
Example	:FREQUency:OFFSet 1 GHz

3.1.4 Freq Step

Setting the value of Freq Step will change the direction key step of center frequency, start frequency, stop frequency and frequency offset.

- At a fixed step change the value of the center frequency can reach the purpose of switching measurement channels rapidly and continuously.
- There are two kinds of frequency step modes: **Auto** and **Manual**. In Auto mode, the Freq step is 1/10 of the span in Non-zero span or equals the RBW while in Zero Span. In Manual mode, you can set the step using the numeric keys.

Command Format	[[:SENSE]:FREQUENCY:CENTer:STEP[:INCRement] [:SENSe]:FREQUENCY:CENTer:STEP[:INCRement]?
Instruction	Specifies the center frequency step size. Gets the center frequency step.
Parameter Type	Float, unit: Hz, kHz, MHz, GHz
Parameter Range	1 Hz ~ 7.5 GHz
Return	Float, unit: Hz
Example	:FREQUENCY:CENTer:STEP 2 MHz

Command Format	[[:SENSE]:FREQUENCY:CENTer:STEP:AUTO OFF ON 0 1 [:SENSe]:FREQUENCY:CENTer:STEP:AUTO?
Instruction	Specifies whether the step size is set automatically based on the span. Gets center frequency step mode.
Parameter Type	Boolean
Parameter Range	OFF ON 0 1
Return	0 1
Example	:FREQUENCY:CENTer:STEP:AUTO OFF

3.1.5 Auto Tune

Automatically search the signal in the full frequency band and adjust the frequency and amplitude parameters to the best state. One key to perform signal search and automatic parameter setting.

- When this function is enabled, Auto Tune is displayed in the status bar of the screen. After the automatic search is complete, Auto Tune disappears.
- Reference level, scale size, input attenuation and other parameters may be modified during automatic search.

Command Format	[[:SENSE]:FREQUENCY:TUNE:IMMEDIATE
Instruction	Perform auto tune
Parameter Type	No parameter
Parameter Range	No parameter
Return	No return
Example	:FREQUENCY:TUNE:IMMEDIATE

3.2 BW

The bandwidth menu contains the RBW (Resolution Bandwidth), VBW (Video Bandwidth), average type and filter type. Filter type includes the EMI filter type that enables EMI measurement controls.

3.2.1 Resolution Bandwidth

Set the resolution bandwidth in order to distinguish between signals which have frequency components that are near one another.

- Reducing the RBW will increase the frequency resolution, but will also increase the sweep time dramatically (Sweep Time is affected by a combination of RBW and VBW when the analyzer is in

Auto mode).

- Generally, the frequency resolution ability is affected by RBW, RBW Filter shape factor, LO Phase noise, and LO Residual FM.
- RBW varies with the span (non-zero span) in Auto RBW mode.
- Under EMI filter, RBW can only be set to 200 Hz, 9 kHz, 120 kHz and 1 MHz with a 6dB shape factor.

Command Format	[[:SENSe]:BWIDth[:RESolution] [:SENSe]:BWIDth[:RESolution]?
Instruction	Specifies the resolution bandwidth. For numeric entries, all RBW types choose the nearest (arithmetically, on a linear scale, rounding up) available RBW to the value entered. Gets the resolution bandwidth.
NOTE	[[:SENSe]:CHPower:BANDwidth[:RESolution] [:SENSe]:OBWidth:BANDwidth[:RESolution] [:SENSe]:ACPower:BANDwidth[:RESolution] [:SENSe]:TOI:BANDwidth[:RESolution] [:SENSe]:HARMonics:BANDwidth[:RESolution] [:SENSe]:TPOWer:BANDwidth[:RESolution] [:SENSe]:SPECTrogram:BANDwidth[:RESolution] [:SENSe]:CNR:BANDwidth[:RESolution]
Parameter Type	Discrete
Parameter Range	1 Hz , 3 Hz , 10 Hz , 30 Hz , 100 Hz , 300 Hz , 1 kHz , 3 kHz , 10 kHz , 30 kHz , 100 kHz , 300 kHz , 1 MHz , 3 MHz , 10 MHz
Return	Float, unit: Hz
Example	:BWIDth 1 kHz

Command Format	[[:SENSe]:BWIDth[:RESolution]:AUTO OFF ON 0 1 [:SENSe]:BWIDth[:RESolution]:AUTO?
Instruction	Turn on/off auto resolution bandwidth state. Gets the resolution bandwidth auto state.
Parameter Type	Boolean
Parameter Range	OFF ON 0 1
Return	0 1
Example	:BWID:AUTO On

3.2.2 Video Bandwidth

Set the video bandwidth in order to filter out the noise outside the video band.

- Reducing the VBW will smooth the trace and helps to highlight small signals from noise, but it will also increase the sweep time (Sweep Time is affected by a combination of RBW and VBW when it is in Auto mode).
- VBW varies with RBW when it is in Auto mode. While in Manual mode, VBW is not affected by RBW.

Command Format	[[:SENSE]:BWIDth:VIDeo [:SENSE]:BWIDth:VIDeo?
Instruction	Specifies the video bandwidth. Gets the video bandwidth.
NOTE	[[:SENSE]:OBWidth:BANDwidth[:RESolution] [:SENSE]:ACPower:BANDwidth[:RESolution] [:SENSE]:TOI:BANDwidth[:RESolution] [:SENSE]:HARMonics:BANDwidth[:RESolution] [:SENSE]:TPOWer:BANDwidth[:RESolution] [:SENSE]:SPECTrogram:BANDwidth[:RESolution] [:SENSE]:CNR:BANDwidth[:RESolution]
Parameter Type	Discrete
Parameter Range	1 Hz , 3 Hz , 10 Hz , 30 Hz , 100 Hz , 300 Hz , 1 kHz , 3 kHz , 10 kHz , 30 kHz , 100 kHz , 300 kHz , 1 MHz , 3 MHz , 10 MHz
Return	Float, unit: Hz
Example	:BWIDth:VIDeo 10 kHz

Command Format	[[:SENSE]:BWIDth:VIDeo:AUTO OFF ON 0 1 [:SENSE]:BWIDth:VIDeo:AUTO?
Instruction	This command turns on/off auto video bandwidth state. Gets the video bandwidth state.
Parameter Type	Boolean
Parameter Range	OFF ON 0 1
Return	0 1
Example	BWIDth:VIDeo:AUTO OFF

3.2.3 V/R Ratio

Set the ratio of VBW to RBW. This value is different while measuring different kinds of signals:

- Sine/Continuous Wave (CW) signals: Use 1 to 3 (for faster sweeps)
- Pulsed/transient signals: Use 10 (to reduce the influence on the amplitude of transient signals)
- Noise signals: Generally use 0.1 (to obtain the average of noises)

Command Format	[[:SENSE]:BWIDth:VIDeo:RATio [:SENSE]:BWIDth:VIDeo:RATio?
Instruction	Specifies the ratio of the video bandwidth to the resolution bandwidth. Gets the ratio of the video bandwidth to the resolution bandwidth.
Parameter Type	Discrete, Float
Parameter Range	0.001, 0.003, 0.01, 0.03, 0.1, 0.3, 1.0, 3.0, 10.0, 30.0, 100.0, 300.0, 1000.0
Return	Float
Example	:BWIDth:VIDeo:RATio 30

3.3 Sweep

3.3.1 Sweep Points

The number of sweep points represents the number of sweep and trace displayed points (201~10001).

More sweep points will improve the resolution of waveform, but also affect the minimum sweep time, and increase the time of data processing and remote access to data, and reduce the response rate.

Under the influence of the scheme, when the sweep type is FFT, the sweep points cannot remain effective all the time, and the actual output points may be less than the sweep points in some states.

Command Format	[:SENSe]:SWEep:POINts [:SENSe]:SWEep:POINts?
Instruction	Sets sweep points. Gets sweep points.
Parameter Type	integer
Parameter Range	201-10001
Example	:SWEep:POINts 2001 :SWEep:POINts?

3.3.2 Sweep Time & Sweep Time Rules

When the sweep type is normal swept, you can change the sweep time (SWT) to control the time required to sweep the current frequency range. The sweep time supports automatic mode and manual mode:

AutoSWT refers to the appropriate sweep time of the analyzer according to the relevant configuration line operation, which satisfies the following calculation logic:

When Span>0:

$$\text{AutoSWT} = \max[\text{minSWT}, k * (f_{\text{span}}/\text{RBW} / \text{VBW}), \text{Points} * \text{ResTimeperPoint}];$$

$$k = 3、12;$$

$$\text{minSWT} = 1 \text{ ms}$$

When Span=0:

$$\text{AutoSWT} = \max[\text{minSWT}, \text{Points} * \text{ResTimeperPoint}];$$

$$\text{minSWT} = 1 \text{ us}$$

Where velocity factor K =3 or 12, corresponding to two supported Sweep Time Rules:Speed or Accuracy; ResTimeperPoint Represents the DSP response time of a sweep point,it is inversely correlated with RBW value.

Users can also manually set the sweep time based on actual requirements. But it needs to be satisfied:

When Span>0: 1ms <= SWT <= 4ks

When Span=0: 1us <= SWT <= 6ks

In general, the manual sweep time should not be longer than the automatic sweep time in this condition. Otherwise, unforeseeable anomalies may be caused and may be marked (UNCAL).

It should be pointed out in particular that under the influence of the scheme, when the sweep type is FFT, the sweep time can only be calculated by the instrument itself, and any modification related to the sweep time cannot take effect.

Command Format	[:SENSE]:SWEep:TIME [:SENSE]:SWEep:TIME?
Instruction	Specifies the time in which the instrument sweeps the display. A span value of 0 Hz causes the analyzer to enter zero span mode. In zero span the X-axis represents time rather than frequency.
Parameter Type	Float, unit: ks, s, ms, us
Parameter Range	1us ~ 6000s
Return	Float, unit: s
Example	:SWEep:TIME 5s

Command Format	[:SENSE]:SWEep:TIME:AUTO OFF ON 0 1 [:SENSE]:SWEep:TIME:AUTO?
Instruction	This command turns on/off auto sweep time state.
Parameter Type	Boolean
Parameter Range	OFF ON 0 1
Return	0 1
Example	:SWEep:TIME:AUTO ON

Command Format	[:SENSE]:SWEep:SPEEd NORMAl ACCUracy [:SENSE]:SWEep:SPEEd?
Instruction	Toggles the sweep speed between normal and accuracy.
Parameter Type	Enumeration
Parameter Range	ACCUracy NORMAl
Example	:SWEep: SPEEd NORMAl

3.3.3 Sweep Time Estimate

The estimated sweep time represents the time actually consumed by each sweep, including data sampling time (sweep time) and related scheduling time.

The estimated sweep time cannot be modified.

3.3.4 Sweep/Measure

Sweep/Measure

Single/Continue controls analyzer to perform single or continuous sweep/measure,

Restart

Restart the current sweep or measure. In particular, if the sweep parameters are modified, a restart will be performed.

Command format	:INITiate:CONTInuous OFF ON 0 1 :INITiate:CONTInuous?
Instructions	Sets continuous sweep mode on-off. Gets continuous sweep mode state.
Parameter Type	Boolean
Parameter Range	OFF ON 0 1
Return	0 1
Example	:INITiate:CONTInuous OFF

Command Format	:INITiate[:IMMEDIATE]
Instruction	Restarts the current sweep.
Example	:INITiate:IMMEDIATE

Command Format	:INITiate:REStart
Instruction	Restarts the current sweep.
Example	:INITiate:REStart

3.4 Amplitude

Set the amplitude parameters of the analyzer. Through modifying these parameters, signals under measurement can be displayed in a proper mode for easier observation and minimum error. Any change of Ref Level, Attenuator Value, Preamp mode and Ref Offset will restart sweep.

3.4.1 Ref Level

Set the maximum power or voltage that can be currently displayed in the trace window. The value is displayed at the upper left corner of the screen grid.

The maximum reference (Ref) level available is affected by the maximum mixing level; input attenuation is adjusted under a constant maximum mixing level in order to fulfill the following condition:

$Ref \leq ATT - PA - 20dBm$, where *ATT* = Attenuation value, *PA* = Preamplifier value

Note: the maximum reference level of different machine models may be different, please refer to the data manual specifically.

Command Format	:DISPlay:WINDow:TRACe:Y[:SCALe]:RLEVel :DISPlay:WINDow:TRACe:Y[:SCALe]:RLEVel?
Instruction	This command sets the reference level for the Y-axis. Gets reference level.
Parameter Type	Float, unit: dBm, dBmV, dBuV, dBuA, V, W
Parameter Range	Unit is dBm : -170 dBm ~ 23 dBm Unit is dBmV : -123.01 dBmV ~ 69.99 dBmV Unit is dBuV : -63.01 dBuV ~ 129.99 dBuV Unit is dBuA : -96.99 dBuA ~ 96.01 dBuA Unit is Volts : 707.11pV ~ 3.16 V Unit is Watts : 0W ~ 199.53m W
Return	Float , unit: dBm
Example	:DISPlay:WINDow:TRACe:Y:RLEVel 20 DBM

3.4.2 Attenuator

Set the value for the internal attenuator of the RF input. So that the large signal can be low distortion and the small signal can pass through the mixer with low noise.

$Ref \leq ATT - PA - 20dBm$, where *ATT* = Attenuation value, *PA* = Preamplifier value

Input attenuation can be set up to auto or manual mode.

- Auto mode: the attenuation value is automatically adjusted according to the state of preamplifier and the current reference level.
- The maximum input attenuation can be set to 50dB , resolution: 2dB. When the set parameters do not meet the above formula, you can adjust the reference level.

Command format	[:SENSe]:POWer[:RF]:ATTenuation [:SENSe]:POWer[:RF]:ATTenuation?
Instructions	Sets/gets the attenuation value
Parameter Type	Integer
Parameter Range	0 dB ~ 50 dB (Even gears only)
Return	Integer , unit dB
Example	:POWer:ATTenuation 10

Command format	[:SENSe]:POWer[:RF]:ATTenuation:AUTO OFF ON 0 1 [:SENSe]:POWer[:RF]:ATTenuation:AUTO?
Instructions	Sets/gets the auto attenuation value switch
Parameter Type	Boolean

Parameter Range	OFF ON 0 1
Return	0 1
Example	:POWer[:RF]:ATTenuation:AUTO ON

3.4.3 RF Preamp

Control the state of the internal preamplifier (PA) located in the RF input signal path. When the signal-under-measurement is small, turning on the preamplifier can reduce the displayed noise level and aid distinguishing small signals from the noise.

The corresponding icon “PA” will appear at the left side of the screen when the preamplifier is turned on.

Command format	[:SENSe]:POWer[:RF]:GAIN[:STATe] OFF ON 0 1 [:SENSe]:POWer[:RF]:GAIN[:STATe]?
Instructions	Sets/gets the preset amplifier inside the switch spectrometer
Parameter Type	Boolean
Parameter Range	OFF ON 0 1
Return	0 1
Example	:POWer:GAIN ON

3.4.4 Ref Offset

Assign an offset to the reference level to compensate for gains or losses generated between the device under measurement and the analyzer.

The change of this value changes both the reference level readout and the amplitude readout of the marker; but does not impact the position of traces on the screen.

Command format	:DISPlay:WINDow:TRACe:Y:SCALE:RLEVel:OFFSet :DISPlay:WINDow:TRACe:Y:SCALE:RLEVel:OFFSet?
Instructions	Sets/gets the frequency offset
Parameter Type	Float
Parameter Range	-100 dB~100 dB
Return	Float , unitdB
Example	:DISPlay:WINDow:TRACe:Y:SCALE:RLEVel:OFFSet 2

3.4.5 Y Axis Scale

3.4.5.1 Scale

Users can change the display range of Y axis by adjusting the scale. The scaling is allowed only the scale type is Log.

- Setting different scales can adjust the display range of the current interface amplitude;

Command format	:DISPlay:WINDow:TRACe:Y[:SCALE]:PDIVision :DISPlay:WINDow:TRACe:Y[:SCALE]:PDIVision?
Instructions	Sets/gets the scale on which trace logarithms are displayed
Parameter Type	Float
Parameter Range	0.1 dB ~ 20 dB
Return	Float , unit dB
Example	:DISPlay:WINDow:TRACe:Y:PDIVision 10 dB

3.4.5.2 Scale Type

Set the scale type of the Y-axis to Lin or Log. The default is Log.

- In Lin mode, the vertical Scale value cannot be changed. The Display area is set for reference level of 0%.
- In Log scale type, the Y-axis denotes the logarithmic coordinate. The value shown at the top of the grid is the reference level and each grid represent the scale value. The unit of Y-axis will automatically switch to the default unit (dBm) in Log scale type when the scale type is changed from Lin to Log.
- In Lin scale type, the Y-axis denotes the liner coordinate; the values shown at the top of the grid and the bottom of the grid are the reference level and 0 V. The scale setting function is invalid. The unit of Y-axis will automatically switch to the default unit (Volts) in Lin scale type when the scale type is charged from Log to Lin.
- The scale type does not affect the setting of Y-axis unit.

Command format	:DISPlay:WINDow:TRACe:Y[:SCALE]:SPACing LINear LOGarithmic :DISPlay:WINDow:TRACe:Y[:SCALE]:SPACing?
Instructions	Sets/Gets the scale display type
Parameter Type	Enumeration : LINear LOGarithmic
Return	Enumeration : LIN LOG
Example	:DISPlay:WINDow:TRACe:Y:SPACing LINear

3.4.5.3 Unit

Set the unit of the Y-axis to dBm, dBmV, dBuV, dBuA, Volts (RMS) or Watts. Default is dBm.

The conversion relationships between units are as follows.

Where, R denotes the reference impedance. The default value is 50Ω and can be adjusted by pressing “**Correction -> RF input**”.

$$\text{dBm} = 10\lg \left(\frac{\text{Volts}^2}{R} \times \frac{1}{1\text{mW}} \right)$$

$$\text{dB}\mu\text{V} = 20\lg \left(\frac{\text{Volts}}{1\mu\text{V}} \right)$$

$$\text{dBmV} = 20 \lg \left(\frac{\text{Volts}}{1\text{mV}} \right)$$

$$\text{dB}\mu\text{A} = 10 \lg \left(\frac{\text{Volts}^2}{R} \times \frac{1}{1\text{mW}} \right) - 10 \lg(R) + 10 \lg 10^9$$

$$\text{Watts} = \frac{\text{Volts}^2}{R}$$

Command format	:UNIT:POWer DBM DBMV DBUV V W :UNIT:POWer?
Instructions	Sets/gets the display unit of magnitude
Parameter Type	Enumeration
Parameter Range	DBM DBMV DBUV DBUA V W
Return	Enumeration: DBM DBMV DBUV V W
Example	:UNIT:POWer DBMV

3.4.6 Correction

Measured value can be corrected in specific x-axis and y-axis. Now, there are eight corrections, witch enter into force at the same time.

Select Correction

Select a correction (1-8) to operating.

Correct Switch

If the selected switch enter into force.

Command Format	[:SENSe]:CORRection:CSET#[[:STATe]] [:SENSe]:CORRection:CSET#[[:STATe]]?
Illustration	Set Correction Switch Status
Parameter Type	Boolean
Menu	Input/Output>Correction
Return Value	0 1
example	:CORRection:CSET1 0 :CORRection:CSET2 1

Edit Correction

Editing, preserving, loading the selected correction.

Command Format	[:SENSe]:CORRection:CSET[1]2[3]...[8]:DATA {x1,y1 } [:SENSe]:CORRection:CSET#:DATA?
Illustration	Get/Set correction points

Parameter Type	Character String of Correction Data {Freq 1Hz, Amp 1dBm, Freq 2Hz, Amp 2dBm,}
Parameter Range	
Menu	Input/Output>Correction>Edit Correction
example	:CORRection:CSET1:DATA 10000000,-15, 15000000, -15 :CORRection:CSET1:DATA 10000000,-15

Command Format	[[:SENSE]:CORRection:CSET[1]2 3 ... 8:ADD {x1,y1 }
Illustration	Add Correction Point
Parameter Type	Character String of Correction Data {Freq 1Hz, Amp 1dBm, Freq 2Hz, Amp 2dBm,}
Parameter Range	
Menu	Input/Output>Correction>Edit Correction
example	:CORRection:CSET1:ADD 10000000,-15, 15000000, -15 :CORRection:CSET1:ADD10000000,15

Command Format	[[:SENSE]:CORRection:CSET[1]2 3 ... 8:POINT:DELEte
Illustration	Delete a special correction point.
Parameter Type	Serial Number
Menu	Input/Output>Correction>Edit Correction
example	:CORRection:CSET1:POINT:DELEte 0

Close All the Correction

All the correction is not effective.

Delet One/All the Correction

Empty all the points of a specail/all correction(s).

Command Format	[[:SENSE]:CORRection:CSET[1]2 3 ... 8:DELEte
Illustration	Delete all points of a special correction.
example	CORRection:CSET1:DELEte

Command Format	[[:SENSE]:CORRection:CSET:ALL:DELEte
Illustration	Delete all the corrections
example	:CORRection:CSET:ALL:DELEte

3.5 Trigger

The analyzer provides a variety of trigger functions, users can choose from the trigger menu.

3.5.1 Trigger Source

The analyzer provides a variety of trigger sources to suit different trigger requirements.

Free Run

Free trigger is the default mode of the analyzer, in which the spectrum analyzer sweeps circularly and continuously.

Video

When the user wants to capture an instantaneous signal that appears for a very short time, the video trigger mode can be adopted. In this working mode, only when the rising edge or falling edge of a signal touches the Trigger Level, the signal will be triggered and displayed on the screen.

External

External trigger provides users with richer trigger functions. If users want to realize the periodic trigger and delay trigger spectrum analyzer, they can choose the external trigger mode. In this mode, it is triggered by the rising or falling edge of the external input signal. The square wave signal with a certain frequency can be periodically triggered, and the delay time can be adjusted by setting the Trigger Delay option.

Periodic

When Periodic is selected, the analyzer uses the built-in period timer signal as the trigger. The trigger event is set by the periodic timer parameter, which is modified by offset and periodic synchronization Src.

You can synchronize periodic signals with external events (using periodic synchronization Src) to get closer to a reliable trigger signal.

If the synchronization source is not selected (off state), the internal timer will not synchronize with any external timed events.

Command format	:TRIGger[:SEQuence]:SOURce :TRIGger[:SEQuence]:SOURce?
Instructions	sets the trigger source. gets the trigger source.
Parameter Type	Enumeration
Parameter Range	"IMMEDIATE ", "VIDeo ", "EXTernal ", "FRAMe"
Return	"IMM", "VID", "EXT", "FRAMe"
Example	:TRIGger:SOURce VID

3.5.2 Trigger Level

Sets the amplitude level for the video trigger (absolute level only supported). When the video signal

crosses the voltage level with the selected slope, it is triggered.

Command format	:TRIGger[:SEQuence]: {type}:LEVel :TRIGger[:SEQuence]: {type}:LEVel?
Instructions	sets the trigger level. gets the trigger level. {type}: "VIDeo", "EXTernal"
Parameter Type	Float
Parameter Range	-300 dBm ~50 dBm
Return	Float
Example	:TRIGger:VIDeo:LEVel -20

3.5.3 Trigger Slope

Set the trigger polarity for external trigger, video trigger. The options are rising edge trigger and falling edge trigger.

The same trigger source uses the same trigger edge for both gating and triggering.

Command format	:TRIGger[:SEQuence]: {type}:SLOPe :TRIGger[:SEQuence]: {type}:SLOPe?
Instructions	sets the trigger edge. gets the trigger edge. {type}: " VIDeo ", " EXTernal "
Parameter Type	Enumeration
Parameter Range	"POS", "NEG"
Return	"POS", "NEG"
Example	:TRIGger: EXTernal:SLOPe :TRIGger: VIDeo:SLOPe?

3.5.4 Trigger Delay

When scanning is at zero span, negative delay can be set . The time range of negative delay is related to the number of sweep points and sweep time:

$$\text{Maximum negative delay time} = [496M / (\text{sweep points} * 64) - 5] * \text{sweep time}$$

$$\text{Maximum positive delay time} = 500\text{ms}$$

Command format	:TRIGger[:SEQuence]:{type}:DELay :TRIGger[:SEQuence]:{type}:DELay?
Instructions	sets the trigger delay gets the trigger delay {type}:" VIDeo ", " EXTernal " ,"FRAMe"
Parameter Type	Float
Return	Float

Example	:TRIGger:EXTernal:DELay 5e-3 :TRIGger:FRAMe:DELay?
Command format	:TRIGger[:SEQuence]:{type}:DELay:STATe :TRIGger[:SEQuence]:{type}:DELay:STATe?
Instructions	sets the trigger delay state. gets the trigger delay state. {type}: " VIdeo ", " EXTernal ", " FRAMe"
Parameter Type	Boolean
Parameter Range	OFF ON 0 1
Return	0 1
Example	:TRIGger:EXTernal: DELay:STATe 1

3.5.5 Zero Span Trigger Delay Compensation (external trigger only)

In normal cases, after the trigger is generated, the data is displayed and the data is triggered at the same time. However, the processing time of the trigger path and the data path is different. As a result, the data displayed at the trigger time is the previous data. This does not affect the integrity of the data and does not cause data loss at the trigger point. However, in some cases, it is necessary to display the zero point of screen coordinate as the input signal information of trigger point, so the function of zero span delay compensation is needed.

Command format	:TRIGger[:SEQuence]:EXTernal:DELay:COMPensation OFF ON 0 1 :TRIGger[:SEQuence]:EXTernal:DELay:COMPensation?
Instructions	Enable /disable the external trigger zero sweep delay compensation
Parameter Type	Boolean
Parameter Range	OFF ON 0 1
Return	0 1
Example	:TRIGger:EXTernal:DELay:COMPensation OFF

3.5.6 Period (periodic trigger only)

Set the trigger period. For gating and triggering, the same trigger source uses the same trigger cycle.

Command format	:TRIGger[:SEQuence]:FRAMe:PERiod :TRIGger[:SEQuence]:FRAMe:PERiod?
Instructions	Set/Query Period Trigger period
Parameter Type	Float
Parameter Range	100ns~10s
Return	Float
Example	:TRIGger:FRAMe:PERiod 1s

3.5.7 Offset Time

Adjust the cumulative offset between the periodic trigger clock and trigger events. The periodic trigger clock cannot be viewed on the software, only the trigger event can be seen. Therefore, in order to adjust the trigger event time, only the offset between the periodic triggering clock and the triggering event can be adjusted. However, the absolute value of the internal offset is unknown, and each modification of the offset is cumulative on the previous basis.

Command format	:TRIGger[:SEQuence]:FRAMe:OFFSet :TRIGger[:SEQuence]:FRAMe:OFFSet?
Instructions	Set/Query Period Trigger period offset
Parameter Type	Float
Parameter Range	0s~10s
Return	Float
Example	:TRIGger:FRAMe:OFFSet 1s

3.5.8 Reset Time Offset Display

Reset the display of cycle trigger time offset.

Command format	:TRIGger[:SEQuence]:FRAMe:OFFSet:DISPlay:RESet
Instructions	Reset Period trigger offset return to zero
Example	:TRIGger:FRAMe:OFFSet:DISPlay:RESet

3.5.9 Sync Source (periodic trigger only)

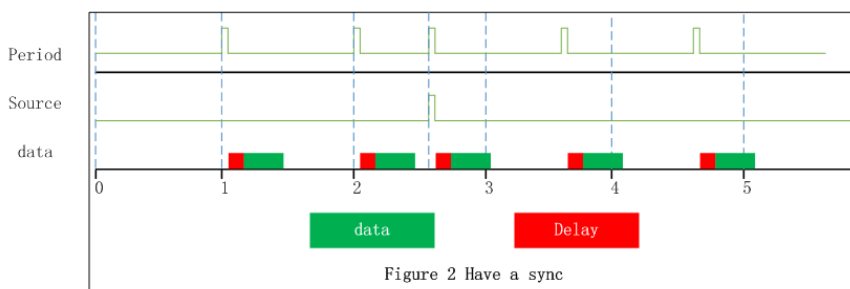
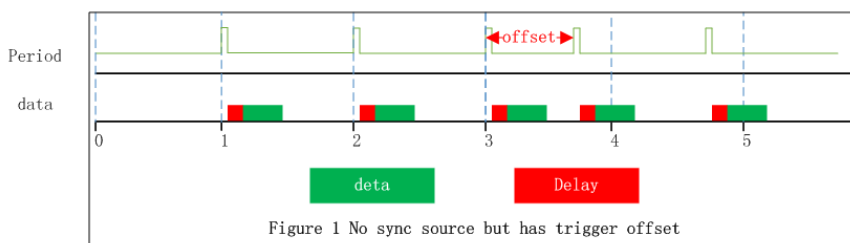

Figure 3-1 Trigger of synchronization source

Command format	:TRIGger[:SEQuence]:FRAMe:SYNC :TRIGger[:SEQuence]:FRAMe:SYNC?
Instructions	Set/Query the type of periodic synchronization
Parameter Type	Enumeration
Parameter Range	"OFF", "EXT"
Return	"OFF", "EXT"
Example	:TRIGger:FRAMe:SYNC EXT

3.5.10 Gate Source

Select a gate source for gate measurement. The optional sources are external source and periodic source.

External

Set the trigger source of the gate to be an external source. Similar to trigger, when configuring external sources, you can choose whether to trigger on the rising edge or the falling edge, and configure zero span delay compensation. The configuration of the gating source affects the configuration of the trigger source.

Period

Set the trigger source of the gate to a periodic source. Similar to trigger, you can configure trigger period, trigger offset, and trigger period synchronization sources when configuring periodic sources. The configuration of the gating source affects the configuration of the trigger source.

Command format	[:SENSe]:SWEep:EGATe:SOURce [:SENSe]:SWEep:EGATe:SOURce?
Instructions	Set or query the gate source type
Parameter Type	Enumeration
Parameter Range	" EXTeRnal ", "FRAMe"
Return	"EXT", "FRAMe"
Example	:SWEep:EGATe:SOURce EXT

3.5.11 Gate

The gate is to separate the spectrum information of some signals that occupy the same part in the frequency domain but are separated from each other in the time domain, such as time division multiple access signals.

3.5.11.1 Gate On

Turn on or off the gate function. When this function is enabled, the gate settings view is closed

Command format	[:SENSe]:SWEep:EGATe[:STATe] [:SENSe]:SWEep:EGATe[:STATe]?
Instructions	Set or query the gate switch

Parameter Type	Boolean
Parameter Range	0 1
Return	0 1
Example	:SWEep:EGATe 1

3.5.11.2 Gate Method

Configure the gate method.

- **LO gate:** In this gate mode, the sweep does not start immediately, but detects the trigger of the gate source first. After the trigger of the gate source, the gate signal is determined according to the gate delay and gate width.

When the gate signal is high, the sweep begins. When the gate signal is low, sweep stops. When the next gate trigger occurs, continue as before until the specified bandwidth has been swept.

In zero span mode, data is collected only when the gate is open, so the setting of the gate will affect the actual sweep time, even though there is no actual sweep process.

- **FFT gate:** In this gate mode, the sweep does not start immediately, but detects the trigger of the gating source first. After the trigger of the gate source, the gate signal is determined according to the gate delay and gate width.

When the gate signal is high, sweep starts, data is collected and FFT transformation is carried out. Since the data processed by FFT needs to be continuous, the gate can be low only after FFT transformation is completed, which is also why the gate length of FFT is a fixed value.

The gate length of FFT needs to be larger than the data length required to complete FFT. When FFT completes a spectrum calculation, the gate will be lower. Then wait for the generation of the next gate trigger and repeat the previous action until the specified bandwidth is swept. FFT gate is unavailable in zero span mode.

- **Video gate:** In this gate mode, after entering the sweep mode, it starts immediately and detects the trigger of the gate source at the same time. After the trigger of the gate source, the gate signal is determined according to the gate delay and the gate width.

When the gate signal is low, the output data is a constant value; when the gate signal is high, the spectrum swept at this time is output. The video trigger does not affect the sweep process, but displays the spectrum of the gate signal at the high moment, and a fixed value at other moments.

With this gate mode, it is usually necessary to set the sweep time to a long time so that the gate signal appears at least once in each display point, thus ensuring that the detector can obtain the real data in the corresponding time interval when the detect mode is peak detect.

Command format	[[:SENSe]:SWEep:EGATe:MEtHod [:SENSe]:SWEep:EGATe:MEtHod?
Instructions	Set/Query the gate method

Parameter Type	Enumeration
Parameter Range	"OFF","LO","VIDeo","FFT"
Return	"OFF","LO","VIDeo","FFT"
Example	:SWEep:EGATe:METhod FFT

3.5.11.3 Gate Length

Set the gate length. This parameter cannot be changed when FFT gate.

The relationship between RBW and gate length in FFT gate mode

RBW	gate length (us)
1Hz	2498064
3Hz	828368
10Hz	272348
30Hz	86968
100Hz	27807
300Hz	10323
1000Hz	5447
3000Hz	2333
10000Hz	1117

Command format	[:SENSe]:SWEep:EGATe:LENGth [:SENSe]:SWEep:EGATe:LENGth?
Instructions	Set/Query the gate length
Parameter Type	Float
Parameter Range	2.106us~5s
Return	Float
Example	:SWEep:EGATe:LENGth 1s

3.5.11.4 Gate Delay

Configure the delay between gate trigger and gate on.

Command format	[:SENSe]:SWEep:EGATe:DELay [:SENSe]:SWEep:EGATe:DELay?
Instructions	Set or query the gate delay
Parameter Type	Float
Parameter Range	Swept : 8.906us~25s Zero span : 1.894us~25s
Return	Float
Example	SWEep:EGATe:DELay 0.005s

3.5.11.5 Gate View

When Turn on this view:

- Disable the gate on/off and the gate function.
- To enter the zero span mode, set different Gate View Sweep Time based on different gate methods. When you close the gate view, the sweep span and sweep time before the gate view is enabled are restored.

Gate View Sweep Time

Controls the sweep time in the gate view window. When selecting different gate methods, the instrument will automatically configure different sweep time.

Gate View Start Time

Set the start time on the left of the gate view, that is, set a delay.

Command format	[[:SENSe]:SWEep:EGATe:VIEW [:SENSe]:SWEep:EGATe:VIEW?
Instructions	Set or query the gate view switch
Parameter Type	Boolean
Parameter Range	0 1
Return	0 1
Example	:SWEep:EGATe:VIEW 1

Command format	[[:SENSe]:SWEep:EGATe:VIEW:START [:SENSe]:SWEep:EGATe:VIEW:START?
Instructions	Set/Query the gate View start time
Parameter Type	Float
Return	Float
Example	:SWEep:EGATe:VIEW:START 1s

Command format	[[:SENSe]:SWEep:EGATe:TIME [:SENSe]:SWEep:EGATe:TIME?
Instructions	Set/Query the gate View time
Parameter Type	Float
Return	Float
Example	[[:SENSe]:SWEep:EGATe:TIME 1s

3.6 Trace

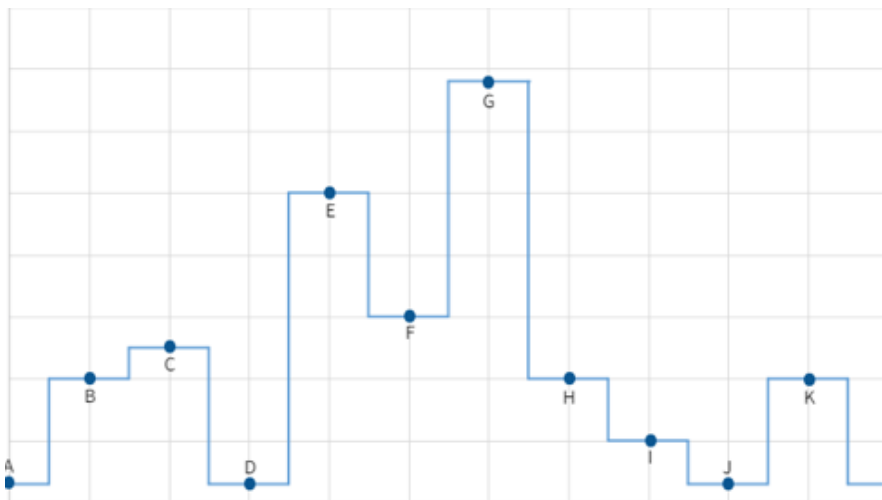

Figure 3-2 trace select

The sweep signal is displayed as a trace on the screen.

Command format	:TRACe[1] 2 3 4 5 6 [:DATA]?
Instructions	Get trace data
Return	String
Example	:TRACe:DATA?

Command format	:FORMat[:TRACe][:DATA]ASCii REAL32 REAL :FORMat[:TRACe][:DATA]?
Instructions	Sets/gets the format of trace data read
Parameter Type	Enumeration
Parameter Range	ASCii REAL32 Floating 32 bit REAL Floating 64 bit
Return	Enumeration : ASCii REAL REAL32
Example	:FORMat ASCii

3.6.1 Select Trace

The analyzer allows for up to four traces to be displayed at the same time. Each trace has its own color (Trace A - Yellow, Trace B - Purple, Trace C - Light blue and Trace D - Green). All traces can be set parameter independently. As a default, analyzer will choose Trace A and set the type of the trace as Clear Write.

Command format	TRACe:SELEct TRACe:SELEct?
Instructions	Sets/gets the current trace
Parameter Type	EnumerationTRACE1-6
Return	Enumeration : TRACE1-6
Example	TRACe:SELEct TRACE3

3.6.2 Trace Type

Set the type of the current trace or disable it. The system calculates the sampled data using a specific operation method according to the trace type selected and displays the result. Trace types include Clear Write, Max Hold, Min Hold, View, Average and Blank. The corresponding icon of the trace type will be displayed in the status bar at the left of the screen, as shown in the figure below.

Clear Write

Erases any data previously stored in the selected trace, and display the data sampled in real-time of each point on the trace.

Max Hold

Retain the maximum level for each point of the selected trace. Update the data if a new maximum level is detected in successive sweeps. Max Hold is very effective when measuring events that may take successive scans to measure accurately. Some common applications include FM Deviation, AM NRSC, and frequency hopping or drift.

Min Hold

Display the minimum value from multiple sweeps for each point of the trace and update the data if a new minimum is generated in successive sweeps.

Average

Set the averages times of the selected trace.

More averages can reduce the noise and the influence of other random signals; thus highlighting the stable signal characteristics. The larger the averages times is, the smoother the trace will be. Enabling averaging will take more time to collect the full spectral information because the analyzer needs to sweep the set average count. The displayed data is averaged in a first-in-first-out fashion.

Command format	:TRACe[1] 2 3 4 5 6:TYPE WRITe MAXHold MINHold AVERAge :TRACe[1] 2 3 4 5 6:TYPE?
Instructions	Sets/gets the display type of trace
Parameter Type	Enumeration
Parameter Range	WRITe : Trace is in normal mode. Update data MAXHold : Displays the maximum value of traces MINHold : Displays the minimum value of trace AVERAge : Displays the average value of trace
Return	Enumeration : WRITE MAXH MINH AVER
Example	:TRAC1:TYPE MINH

3.6.3 Trace State

There are four trace states: active, view, blank, and background. Different trace states indicate the refresh and display states of traces:

Active

Refreshed and displayed trace data.

View

The trace data will not be refreshed, and the current latest trace will be displayed in a fixed frame.

Blank

Trace data is no longer refreshed or displayed

Background

Refreshed trace data but no display.

Command format	:TRACe[1] 2 3 4 5 6:DISPlay[:STATe] :TRACe[1] 2 3 4 5 6:DISPlay[:STATe]?
Instructions	Sets/gets the display status of the trace
Parameter Type	Enumeration : ACTI VIEW BLAN BACK
Parameter Range	ACTIve : Trace is in normal mode. Update data VIEW : Stops updating trace to display current trace data BLANK : Clear trace data BACKground : Set as background
Return	Enumeration : ACTI VIEW BLAN BACK
Example	:TRACe2:DISPlay BLANK :TRACe2:DISPlay?

3.6.4 Detect

The analyzer displays the sweep signal on the screen in the form of a trace. For each trace point, the analyzer always captures all the data within a specific time interval and processes (Peak, Average, etc.) the data using the detector currently selected, then it displays the processed data (a single data point) on the screen.

Select an appropriate detector type according to the actual application in order to ensure the accuracy of the measurement.

The available types are **Pos Peak**, **Neg Peak**, **Sample**, **Normal**, **Average** and **Quasi Peak**. The default is **Pos peak**.

Positive Peak

For each trace point, Positive Peak detector displays the maximum value of data sampled within the corresponding time interval.

Negative Peak

For each trace point, Negative Peak detector displays the minimum value of data sampled within the corresponding time interval.

Sample

For each trace point, Sample detector displays the transient level corresponding to the central time point of the corresponding time interval. This detector type is applicable to noise or noise-like signal.

Normal

Normal detector (also called ROSENFELL Detector) displays the maximum value and the minimum value of the sample data segment in turn: Odd-numbered data points display the maximum value and even-numbered data points display the minimum value. In this way, the amplitude variation range of the signal is clearly shown.

Average

For each trace point, Average detector displays the average value of data sampled within the corresponding time interval.

Command format	[[:SENSe]:DETECTOR:TRACe[1] 2 3 4 5 6[:FUNCTION] [:SENSe]:DETECTOR:TRACe[1] 2 3 4 5 6[:FUNCTION]?
Instructions	Sets/Gets the trace detection type
Parameter Type	Enumeration NEG POS SAMP AVER NORMAL
Parameter Range	NORMAL : standard NEGative : Negative peak POSitive : positive peak SAMPle : The sampling AVERage : average,
Return	Enumeration : NEG POS SAMP AVER NORMAL
Example	:DETECTOR:TRAC1 AVERage

Command format	[[:SENSe]:DETECTOR:TRACe[1] 2 3 4 5 6:AUTO 0 1 [:SENSe]:DETECTOR:TRACe[1] 2 3 4 5 6:AUTO? [:SENSe]:DETECTOR:TRACe:AUTO:ALL
Instructions	Set/get trace automatic detection switch
Parameter Type	Boolean
Parameter Range	0 1
Return	0 1
Example	:DETECTOR:TRACe3:AUTO 1 :DETECTOR:TRACe:AUTO:ALL

3.6.5 Math

Set the computational method of the math trace.

Output Z

The Math result is denoted by the Z variable and can be displayed by trace

Input X, Y

Input X, Y can be applied to trace

Calculation Type

The analyzer provides the calculation types as shown below:

Power Diff : X-Y+Offset→Z

Power Sum : X+Y+Offset→Z

Log Offset : X+ Offset→Z

Log Diff : X-Y-Ref→Z

Offset value

Command format	:TRACe[1] 2 3 4 5 6:MATH:X :TRACe[1] 2 3 4 5 6MATH:X?
Instructions	Sets/gets the x-trace of the variable
Parameter Type	Enumeration
Parameter Range	TRACE1-6
Return	Enumeration
Example	:TRACe3:MATH:X 5

Command format	:TRACe:MATH:Y [1] 2 3 4 5 6 :TRACe:MATH:Y?
Instructions	Set the variable Y trace Get the variable y-trace
Parameter Type	Enumeration
Parameter Range	TRACE1-6
Return	Enumeration
Example	:TRACe1:MATH:Y 3

Command format	:CALCulate[:SElected]:MATH:FUNcTion :CALCulate[:SElected]:MATH:FUNcTion?
Instructions	Sets/gets the trace calculation type
Parameter Type	Enumeration
Parameter Range	OFF PDIF : Power subtracting PSUM : Power up LOFF : Logarithmic deviation LDIF : Logarithmic subtraction
Return	Enumeration
Example	:CALCulate:MATH:FUNcTion PDIF

Command format	:TRACe[1] 2 3 4 5 6:MATH:OFFSet :TRACe[1] 2 3 4 5 6:MATH:OFFSet?
Instructions	Set the LOG OFFSET constant Ask for the LOG OFFSET constant
Parameter Type	Integer
Parameter Range	-100dB-100dB
Return	-100dB-100dB
Example	:TRACe1:MATH:OFFSet -10 :TRACe3:MATH:OFFSet?

Command format	:TRACe[1] 2 3 4 5 6:MATH:REFerence :TRACe[1] 2 3 4 5 6:MATH:REFerence?
Instructions	Sets/gets the LOG DIFF constant

Parameter Type	Integer
Parameter Range	-100dB-100dB
Return	-100dB-100dB
Example	:TRACe5:MATH:REFerence 10 :TRACe6:MATH:REFerence?

3.6.6 Normalize

Trace normalization function. Please save the reference trace before using this function.

Command format	:CALCulate:NTData:STORE:REF
Instructions	Set normalization to save the reference trace
Example	:CALCulate:NTData:STORE:REF

Command format	:CALCulate:NTData[:STATe] OFF ON 0 1 :CALCulate:NTData[:STATe]?
Instructions	Set/read switch normalization
Parameter Type	Boolean
Parameter Range	0 1
Return	0 1
Example	:CALCulate:NTData 1

Command format	:DISPlay:WINDow:TRACe:Y[:SCALe]:NRLevel :DISPlay:WINDow:TRACe:Y[:SCALe]:NRLevel?
Instructions	Sets/gets the normalized reference level
Parameter Type	Float , unitdB
Parameter Range	-200 dB ~ 200 dB
Return	Float , unitdB
Example	:DISPlay:WINDow:TRACe:Y:NRLevel 10

Command format	:DISPlay:WINDow:TRACe:Y[:SCALe]:NRPosition :DISPlay:WINDow:TRACe:Y[:SCALe]:NRPosition?
Instructions	Sets/reads the normalized reference location
Parameter Type	Integer
Parameter Range	0 ~ 100
Return	Integer
Example	:DISPlay:WINDow:TRACe:Y:NRPosition 10

Command format	:DISPlay:WINDow:NTTRace[:STATe] :DISPlay:WINDow:NTTRace[:STATe]?
Instructions	Sets/gets the normalized reference trace switch
Parameter Type	Boolean
Parameter Range	0 1
Return	0 1
Example	:DISPlay:WINDow:NTTRace 1

3.6.7 Trace Function

Trace function supports the following operations on the specified trace

Trace Copy

Copy data from the source trace to the destination trace. After copying, the trace state of the target trace is automatically changed to view.

Trace Exchange

Exchange the data of the source trace with the data of the target trace. After the exchange, the trace status of the source trace and the target trace will be automatically changed to view.

Preset All Traces

The settings and data of all traces are changed to the default state.

Clear All Traces

Clear all traces data.

Command format	:TRACe:COpy
Instructions	Copy the trace
Example	:TRACe:COpy 1,2

Command format	:TRACe:EXCHange
Instructions	Exchange of trace
Example	:TRACe:EXCHange 1,2

Command format	:TRACe:PRESet:ALL
Instructions	Reset all traces
Example	:TRACe:PRESet:ALL

Command format	:TRACe:CLEar:ALL
Instructions	Clear all traces
Example	:TRACe:CLEar:ALL

3.7 Marker & Peak

The marker appears as a rhombic sign (as shown below) for identifying points on a trace. You can easily read the amplitude, frequency and sweep time of the marked point on the trace.

- The analyzer allows for up to eight/four pairs of markers to be displayed at one time, but only one pair or a single marker is active every time.
- You can use the numeric keys, knob or direction keys to modify the desired frequency or time as well as view the readouts of different points on the trace.

3.7.1 Select Marker

Select one of the eight markers. The default is Marker1. When a marker is selected, you can set its type, trace to be marked, readout type and other related parameters. The enabled marker will appear on the trace selected through the **Select Trace** option and the readouts of this marker are also displayed in the active function area and at the upper right corner of the screen.

Command format	:CALCulate:MARKer:SELEct :CALCulate:MARKer:SELEct?
Instructions	Sets/Gets the current marker
Parameter Type	Enumeration1-8
Return	Enumeration : 1-8
Example	:CALCulate:MARKer:SELEct 5

3.7.2 Select Trace

Select the trace to be marked by the current marker. Valid selections include Trace1,2,3,4,5,6.

Command format	:CALCulate:MARKer[1] 2 3 4 5 6 7 8:TRACe 1 2 3 4 5 6 :CALCulate:MARKer[1] 2 3 4 5 6 7 8:TRACe?
Instructions	Sets/Gets the marker trace
Parameter Type	Enumeration
Parameter Range	1 2 3 4 5 6
Return	Enumeration
Example	CALCulate:MARK:TRAC 1

3.7.3 Marker Type

3.7.3.1 Normal

One of the marker types. It is used to measure the X (Frequency or Time) and Y (Amplitude) values of a certain point on the trace. When selected, a marker with the number of the current marker (such as " 1 ") appears on the trace.

- If no active marker exists currently, a marker will be enabled automatically at the center frequency of the current trace.
- You can use the numeric keys, knob or direction keys to move the marker. The readouts of the marker will be displayed at the upper right corner of the screen.
- The readout resolution of the X-axis (frequency or time) is related to the span. For higher readout resolution, reduce the span.

3.7.3.2 Delta

One of the marker types. It is used to measure the delta values of X (Frequency or Time) and Y (Amplitude) between the reference point and a certain point on the trace. When selected, a pair of

markers appears on the trace: Fixed Related Marker (marked by a combination of the marker number and letter “ + ”, such as “ 2+ ”) and the Delta Marker (marked by the “Δ”, such as “ 1Δ2 ”).

- After the marker selects “Delta”, the original marker will become the delta measurement marker, and the related marker of the incrementing sequence number will become the reference “fixed” marker
- The delta marker is in the "relative to" state, and its X-axis position can be changed; the related marker is in the "fixed" state by default (the X-axis and Y-axis positions are fixed), but the X-axis can be adjusted by changing to the "normal" state.
- The first row in the upper right corner of the trace area shows the frequency (or time) difference and amplitude difference between the two markers; the second row in the upper right corner of the trace area shows the X axis and amplitude value of the related marker.
- Delta reset. It is only valid when the current marker is a differential marker. If the marker type of the relative marker of the current marker is normal or differential, change the horizontal position of the relative marker to the horizontal position of the current marker; if the marker type of the relative marker is fixed, change the horizontal position and vertical position of the relative marker to the current one. The horizontal and vertical position of the marker.

3.7.3.3 Fixed

One of the marker types. When “Fixed” is selected, the X-axis and Y-axis of the marker will not change by the trace and can only be changed through the menu. The fixed marker is marked with "+". After the marker selects “Delta”, the original marker will become the delta measurement marker, and the related marker of the incrementing sequence number will become the reference “fixed” marker

3.7.3.4 Off

Turn off the marker currently selected. The marker information displayed on the screen and functions based on the marker will also be turned off.

Command format	:CALCulate:MARKer[1][2][3][4][5][6][7][8]:MODE POSition DELTA FIXed OFF :CALCulate:MARKer[1][2][3][4]:MODE?
Instructions	Sets/Gets the marker mode
Parameter Type	Enumeration
Parameter Range	POSition DELTA FIXed OFF
Return	Enumeration : POS DELT FIX OFF
Example	:CALCulate:MARK1:MODE POSition

Command format	:CALCulate:MARKer[1][2][3][4][5][6][7][8]:STATe OFF ON 0 1 :CALCulate:MARKer[1][2][3][4][5][6][7][8]:STATe?
Instructions	Sets/gets the marker switch status
Parameter Type	Boolean

Parameter Range	OFF ON 0 1
Return	0 1
Example	:CALCulate:MARK1:STATe ON

Command format	:CALCulate:MARKer:AOff
Instructions	Close all markers
Example	:CALCulate:MARKer:AOff

Command format	:CALCulate:MARKer[1] 2 3 4 5 6 7 8 [:SET]:RESEt:DELTA
Instructions	Difference marker resets to 0 Only valid when the current cursor is a differential marker
Example	:CALCulate:MARKer2:RESEt:DELTA

3.7.4 Marker Postion

Displays and sets the position of the marker. Only the x-axis position can be set.

Command format	:CALCulate:MARKer[1] 2 3 4 5 6 7 8:X :CALCulate:MARKer[1] 2 3 4 5 6 7 8:X?
Instructions	Sets/gets the value of the marker point X axis This command takes effect only when the marker mode is not OFF : :CALCulate:MARKer[1] 2 3 4 5 6 7 8:STATe :CALCulate:MARKer[1] 2 3 4 5 6 7 8:MODE If the marker readout type is frequency, the parameter is frequency. When the marker readout type is time, the value is time. Reference commands: :CALCulate:MARKer[1] 2 3 4 5 6 7 8:X:READout
Parameter Type	frequency , Float , unitHz , kHz , MHz , GHz , default Hz or time , Float , unitus , ms , s , ks , default s
Parameter Range	0 Hz ~ max span or 10 ms ~ 1000 s
Return	When the marker readout type is frequency, the reading is frequency, floating point type, in Hz; When the marker readout type is time, the reading is time, floating point type, in s; When the marker readout type is cycle, the reading is cycle, floating point type, unit s;
Example	:CALCulate:MARKer4:X 0.4 GHz :CALCulate:MARKer4:X 200 ms :CALCulate:MARKer4:X?

Command format	:CALCulate:MARKer[1] 2 3 4 5 6 7 8:Y :CALCulate:MARKer[1] 2 3 4 5 6 7 8:Y?
Instructions	Read the value of the Y-axis of the marker point, which can also be used to read the marker noise in the marker function. To execute this command, ensure that the marker is in the onstate.:CALCulate:MARKer[1] 2 3 4 5 6 7 8:STATe :CALCulate:MARKer[1] 2 3 4 5 6 7 8:MODE
Parameter Type	Float
Parameter Range	None
Return	Float , unitdBm
Example	:CALCulate:MARKer1:Y? Return : -25

3.7.5 Relative To

“Relative to” is used to measure the delta values of X (Frequency or Time) and Y (Amplitude) between two markers which can mark on different traces.

After the marker selects “Delta”, the original marker will become the delta measurement marker, and the related marker of the incrementing sequence number will become the reference “fixed” marker

Command format	:CALCulate:MARKer[1 2 3 4 5 6 7 8:REFerence 1 2 3 4 :CALCulate:MARKer[1 2 3 4 5 6 7 8:REFerence?
Instructions	Sets/Gets the marker relative to
Parameter Type	Enumeration
Parameter Range	1 2 3 4 5 6 7 8
Return	Enumeration
Example	:CALCulate:MARKer1:REFerence 3

3.7.6 Readout Type

Select a desired readout type for the X-axis for the marker. Different markers can use different readout types. This setting will change the readout type and affect the marker readings in the active function area and at the upper right corner of the screen, but will not change the actual value.

Frequency

In this type, Normal marker shows the absolute frequency. Delta markers and Delta Pair markers show the frequency difference between the delta marker and reference marker. The default readout mode in non-zero span is “**Frequency**”.

Note: This type is invalid in Zero span.

Period

In this type, the Normal marker shows the reciprocal of frequency; while Delta marker and Delta Pair marker show the reciprocal of frequency difference. When the frequency difference is zero, the reciprocal is infinite and 100 Ts is displayed.

Note: This type is invalid in Zero span.

Time

In this type, the Normal marker shows the time difference between the marker and the start of the sweep; while Delta marker and Delta Pair marker show the sweep time difference between the delta marker and reference marker.

The default readout mode in Zero span is Time.

Inverse Time

In this type, the Normal marker Inverse Time = 1 / Time; while Delta marker and Delta Pair marker Inverse Time = 1 / Δ Time.

Command format	:CALCulate:MARKer[1] 2 3 4 5 6 7 8:X:READout FREQuency TIME PERiod INTIme :CALCulate:MARKer[1] 2 3 4 5 6 7 8:X:READout?
Instructions	Sets/gets the marker in X-axis reading mode
Parameter Type	Enumeration
Parameter Range	FREQuency , frequency TIME PERiod INVERSE_TIME
Return	Enumeration: FREQ TIME PER INTIme
Example	:CALCulate:MARKer1:X:READout FREQuency

Command format	:CALCulate:MARKer[1] 2 3 4 5 6 7 8:X:READout:AUTO 0 1 :CALCulate:MARKer[1] 2 3 4 5 6 7 8:X:READout:AUTO?
Instructions	Sets/gets the marker in X-axis reading mode auto
Parameter Type	Boolean
Parameter Range	OFF ON 0 1
Return	0 1
Example	:CALCulate:MARKer1:X:READout:AUTO 1

3.7.7 Marker Couple

When Marker Couple is on, Markers are set up and moved in coupled operation on all traces.

When Marker Couple is off, Markers are set up and moved independently for each trace.

Command format	:CALCulate[:SELected]:MARKer:COUPle :CALCulate[:SELected]:MARKer:COUPle?
Instructions	Set/query the marker coupling switch
Parameter Type	Boolean
Parameter Range	ON OFF 0 1
Return	0 1
Example	:CALCulate:MARKer:COUPle 1 :CALCulate:MARKer:COUPle?

3.7.8 Marker Lines

Mark the marker with the intersection of horizontal and vertical lines, which is more convenient to query the marker position in the waveform area.

Command format	:CALCulate:MARKer[1] 2 3 4 5 6 7 8:X:LINE:STATe :CALCulate:MARKer[1] 2 3 4 5 6 7 8:X:LINE:STATe?
Instructions	Sets/gets the marker line switch
Parameter Type	Boolean
Parameter Range	ON OFF 0 1
Return	0 1
Example	:CALCulate:MARKer2:X:LINE:STATe 1 :CALCulate:MARKer2:X:LINE:STATe?

3.7.9 Marker Table

Enable or disable the Marker Table.

Display all the markers enabled on the lower portion of the screen, including marker number, trace number, marker readout type, X-axis readout and amplitude. Through this table you can view the measurement values of multiple points. The table allows for up to eight markers to be displayed at one time.

Command format	:CALCulate:MARKer:TABLE ON OFF 0 1 :CALCulate:MARKer:TABLE?
Instructions	Sets/gets the marker table state
Parameter Type	Boolean
Parameter Range	ON OFF 0 1
Return	0 1
Example	:CALCulate:MARKer:TABLE ON

3.7.10 Marker ->

3.7.10.1 M->CF

Set the center frequency of the analyzer to the frequency of the current marker.

- If the **Normal** marker is selected, the center frequency will be set to the frequency of the current marker.
- If the **Delta** or **Delta Pair** marker is selected, the center frequency will be set to the frequency of the Delta Marker.
- The function is invalid in Zero span.

Command format	:CALCulate:MARKer[1] 2 3 4 5 6 7 8[:SET]:CENTer
Instructions	Sets/gets the value of the marker X axis to the center frequency .If the marker is not open, this command automatically turns the marker on the center frequency.
Example	:CALCulate:MARKer1:CENTer

3.7.10.2 M -> CF Step

Set the center frequency step of the analyzer to the frequency of the current marker.

- If the **Normal** marker is selected, the center frequency step will be set to the frequency of the current marker.
- If the **Delta** or **Delta Pair** marker is selected, the center frequency step will be set to the frequency of the Delta Marker.
- The function is invalid in Zero span.

Command format	:CALCulate:MARKer[1] 2 3 4 5 6 7 8[:SET]:STEP
Instructions	Sets/gets the value of the marker X axis to mid-frequency step If the marker is not open, this command automatically turns the marker on the center frequency.
Example	:CALCulate:MARKer1:STEP

3.7.10.3 M -> Start Freq

Set the start frequency of the analyzer to the frequency of the current marker.

- If the **Normal** marker is selected, the start frequency will be set to the frequency of the current marker.
- If the **Delta** or **Delta Pair** marker is selected, the start frequency will be set to the frequency of the Delta Marker.
- The function is invalid in Zero span.

Command format	:CALCulate:MARKer[1] 2 3 4 5 6 7 8[:SET]:START
Instructions	Sets/gets the value of the marker X axis to the starting frequency, valid when the marker is on
Example	:CALCulate:MARKer1:START

3.7.10.4 M -> Stop Freq

Set the stop frequency of the analyzer to the frequency of the current marker.

- If the **Normal** marker is selected, the stop frequency will be set to the frequency of the current marker.
- If the **Delta** or **Delta Pair** marker is selected, the stop frequency will be set to the frequency of the Delta Marker.
- The function is invalid in Zero span.

Command format	:CALCulate:MARKer[1] 2 3 4 5 6 7 8[:SET]:STOP
Instructions	Sets/gets the value of the marker X axis to terminate frequency If the corresponding marker is not open, sending this command will automatically open the marker at the end frequency.
Example	:CALCulate:MARKer1:STOP

3.7.10.5 M ->Ref Level

Set the reference level of the analyzer to the amplitude of the current marker.

- If the **Normal** marker is selected, the reference level will be set to the amplitude of the current marker.
- If the **Delta** or **Delta Pair** marker is selected, the reference level will be set to the amplitude of the Delta Marker.

Command format	:CALCulate:MARKer[1] 2 3 4 5 6 7 8[:SET]:RLEVel
Instructions	Sets/gets the value of the marker Y-axis as a reference level If the marker is not open, this command automatically turns the marker on the center frequency.
Example	:CALCulate:MARKer2:RLEVel

3.7.10.6 ΔM->Span

Set the span of the analyzer to the frequency difference between the two markers in Delta marker type.

- If the **Normal** marker is selected, this function is invalid.
- The function is invalid in Zero span.

Command format	:CALCulate:MARKer[1] 2 3 4 5 6 7 8:DELTA[:SET]:SPAN
Instructions	Sets/gets the difference between the marker and the X axis to sweep width This command takes effect only when the marker mode is DELTA :CALCulate:MARKer[1] 2 3 4 5 6 7 8:MODE
Example	:CALCulate:MARKer2:DELTA:SPAN

3.7.10.7 ΔM->CF

Set the center frequency of the analyzer to the frequency difference between the two markers in **Delta** marker type.

- If the **Normal** marker is selected, this function is invalid.
- The function is invalid in Zero span.

Command format	:CALCulate:MARKer[1] 2 3 4 5 6 7 8:DELTA[:SET]:CENTer
Instructions	Sets/gets the difference between the marker and the X axis to the center frequency This command takes effect only when the marker mode is DELTA :CALCulate:MARKer[1] 2 3 4 5 6 7 8:MODE
Example	:CALCulate:MARKer3:DELTA:CENTer

3.7.11 Marker Fn

Special marker functions including Noise Marker, N dB BW and Freq Counter.

Command format	:CALCulate:MARKer[1] 2 3 4 5 6 7 8:FUNctioN OFF FCOUNT NOISE NDB :CALCulate:MARKer[1] 2 3 4 5 6 7 8:FUNctioN?
-----------------------	--

Instructions	Set/Get marker function
Parameter Type	Enumeration
Parameter Range	OFF : normal NOISe : noisy marker NDB : N dB marker
Return	Enumeration: OFF NOISe NDB
Example	:CALCulate:MARK1:FUNCTION NOISe

3.7.11.1 N dB BW

Enable the N dB BW measurement or set the value of N dB. The N dB BW denotes the frequency difference between two points that are located on both sides of the current marker and with N dB fall (N Less than or equal to 0) or rise (N>0) in amplitude as shown in the figure on the next page.

When the measurement starts, the analyzer will search for the two points which are located at both sides of the current point with N dB fall or rise in amplitude and display the frequency difference between the two points in the active function area. "----" would be displayed if the search fails.

The parameters in the figure are shown as :

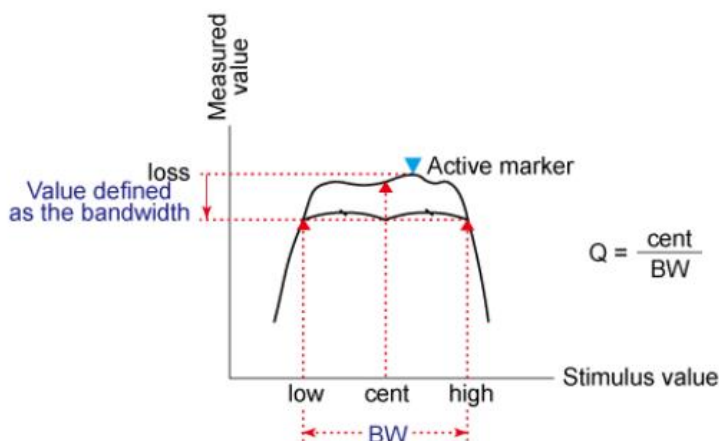

Figure 3-3 N dB parameter

[mkr_ndb_bw](#)

Command format	:CALCulate:MARKer[1] 2 3 4 5 6 7 8:BANDwidth:NDB :CALCulate:MARKer[1] 2 3 4 5 6 7 8:BANDwidth:NDB?
Instructions	Set/Obtain the N dB bandwidth reference value
Parameter Type	Float
Parameter Range	-100 dB ~ 100 dB
Return	Float
Example	:CALCulate:MARK1:BANDwidth:NDB 10 DB

Command format	:CALCulate:MARKer[1]2 3 4 5 6 7 8:BANDwidth:RESult?
Instructions	Result of setting/reading N dB bandwidth
Return	Float
Example	:CALCulate:MARK1:BANDwidth:RESult?

3.7.11.2 Freq Counter

Turn on or off the frequency counter. The frequency readout is accuracy is up to 0.01 Hz.

- The function is valid only when selecting marker 1.
- If marker 1 is selected but not active, turning on the frequency counter will open marker 1 Normal marker automatically.
- The frequency counter measures the frequency near the center frequency in Zero span.

Command format	:CALCulate:MARKer[1]2 3 4 5 6 7 8:FCOunt:[:STATe] ON OFF 0 1 :CALCulate:MARKer[1]2 3 4 5 6 7 8:FCOunt:[:STATe]?
Instructions	Sets/gets the marker frequency counter state
Parameter Type	Boolean
Parameter Range	ON OFF 0 1
Return	0 1
Example	:CALCulate:MARK1:FCOunt 1

Command format	:CALCulate:MARKer[1]2 3 4 5 6 7 8:FCOunt:X?
Instructions	Read the marker frequency counter reading
Return	Float
Example	:CALCulate:MARK1:FCOunt:X?

3.7.11.3 Noise Marker

Execute the Noise marker function for the selected marker and read the normalized noise power spectral density.

- If the current marker is “ **Off** ” in the Marker menu, pressing **Noise Marker** will first set it to Normal type automatically; then measure the average noise level at the marked point and normalize this value to 1 Hz bandwidth. During this process, certain compensation is always made based on the detection and trace types. The measurement will be more precise if RMS Avg or Sample detection type is used.
- This function can be used for measuring the C/N ratio.

3.7.11.4 Off

Turn off the noise marker, N dB BW measurement or Frequency Counter, but not the marker itself.

3.7.12 Peak Search

Open the peak search setting menu and execute peak search.

3.7.12.1 Peak Search

Next Search

Execute peak search and mark the peak.

Minium Peak

Execute minimum search and mark the minium peak.

Next Peak

Search for and mark the peak whose amplitude is closest to that of the current peak and which meets the peak search condition.

Next Left Peak

Search for and mark the nearest peak which is located at the left side of the current peak and meets the peak search condition.

Next Right Peak

Search for and mark the nearest peak which is located at the right side of the current peak and meets the peak search condition.

Peak Peak

Execute peak search and minimum search at the same time and mark the results with delta pair markers. Wherein, the result of peak search is marked with the delta marker and the result of minimum search is marked with the reference marker.

Peak -> CF

Execute peak search and set the center frequency of the analyzer to the frequency of the peak. The function is invalid in Zero Span.

Command format	:CALCulate:MARKer[1] 2 3 4 5 6 7 8:MAXimum
Instructions	Marker searches for peaks and marks them with the specified marker (If peak-to-peak value is on, peak-to-peak value search is carried out; otherwise, single peak value search is carried out, refer to the command:CALCulate:MARKer[1] 2 3 4 5 6 7 8:PTPeak:STATe Search criteria include peak type, absolute threshold, and relative offset :CALCulate:MARKer:PEAK:SEARch:MODE :CALCulate:MARKer:PEAK:THReshold :CALCulate:MARKer:PEAK:EXCursion)
Example	:CALCulate:MARKer4:MAXimum

Command format	:CALCulate:MARKer[1] 2 3 4 5 6 7 8:MINimum
Instructions	Marker searches for the minimum peak and marks it with the specified marker
Example	:CALCulate:MARKer4:MINimum

Command format	:CALCulate:MARKer[1] 2 3 4 5 6 7 8:MAXimum:NEXT
Instructions	Marker searches for the next peak and marks it with the specified marker (Based on the set search criteria, including peak type, absolute threshold, and relative offset, see the following command:CALCulate:MARKer:PEAK:SEARch:MODE :CALCulate:MARKer:PEAK:THReshold :CALCulate:MARKer:PEAK:EXCursion)
Example	:CALCulate:MARKer1:MAXimum:NEXT

Command format	:CALCulate:MARKer[1] 2 3 4 5 6 7 8:MAXimum:LEFT :CALCulate:MARKer[1] 2 3 4 5 6 7 8:MAXimum:RIGHT
Instructions	Marker searches for left/right peaks and marks with the specified marker (Based on the set search criteria, including peak type, absolute threshold, and relative offset, see the following command :CALCulate:MARKer:PEAK:SEARch:MODE :CALCulate:MARKer:PEAK:THReshold :CALCulate:MARKer:PEAK:EXCursion)
Example	:CALCulate:MARKer1:MAXimum:LEFT

Command format	:CALCulate:MARKer[1] 2 3 4 5 6 7 8:PTPeak
Instructions	Performs a peak-to-peak search, marking with the specified marker
Example	:CALCulate:MARKer1:PTPeak

Command format	:CALCulate:MARKer[1] 2 3 4 5 6 7 8:MAXimum[:SET]:CENTER
Instructions	Execute peak search and set the center frequency of the analyzer to the frequency of the peak
Example	:CALCulate:MARKer1:MAXimum:CENTER

3.7.12.2 Peak Config

Define the conditions of peak search for various peak searches. A real peak should meet the requirements of both the **“Peak Threshold”** and **“Peak Excursion”**.

Peak Threshold

Assign a minimum for the peak amplitude. Peaks whose amplitudes are greater than the specified peak threshold are treated as real peaks. The actual minimal peak threshold is -200dBm when shut down the Peak Threshold.

Peak Excursion

Set the excursion between the peak and the minimum amplitude on both sides of it. Peaks whose excursions are beyond the specified excursion are treated as real peaks. The actual minimal peak excursion is 0dBm when shut down the Peak Excursion.

Command format	:CALCulate:MARKer:PEAK:THReshold :CALCulate:MARKer:PEAK:THReshold?
Instructions	Sets/gets the absolute threshold for the peak search criteria
Parameter Type	Float , unitdBm

Parameter Range	-200.0 dBm~ 200.0 dBm
Return	Float , unitdBm
Example	:CALCulate:MARKer:PEAK:THReshold -50

Command format	:CALCulate:MARKer:PEAK:THReshold:STATe :CALCulate:MARKer:PEAK:THReshold:STATe?
Instructions	Set or obtain the absolute threshold switch
Parameter Type	Boolean
Parameter Range	OFF ON 0 1
Return	0 1
Example	:CALCulate:MARKer1:CPSEarch ON

Command format	:CALCulate:MARKer:PEAK:EXCursion :CALCulate:MARKer:PEAK:EXCursion?
Instructions	Sets/gets a relative threshold for the peak search criteria
Parameter Type	Float , unitdB
Parameter Range	0 ~ 200.0 dB
Return	Float , unitdB
Example	:CALCulate:MARKer:PEAK:EXCursion 10

Command format	:CALCulate:MARKer:PEAK:EXCursion:STATe :CALCulate:MARKer:PEAK:EXCursion:STATe?
Instructions	Set and obtain the relative threshold switch
Parameter Type	Boolean
Parameter Range	OFF ON 0 1
Return	0 1
Example	:CALCulate:MARKer:PEAK:EXCursion:STATe ON

3.7.12.3 Count Peak

Enable or disable continuous peak search. The default is Off. When enabled, the system will always execute a peak search automatically after each sweep in order to track the signal under measurement.

Command format	:CALCulate:MARKer[1] 2 3 4 5 6 7 8:CPSearch[:STATe] :CALCulate:MARKer[1] 2 3 4 5 6 7 8:CPSearch[:STATe]?
Instructions	Enable the continuous peak search function Gets the status of the continuous peak search function switch
Parameter Type	Boolean
Parameter Range	OFF ON 0 1
Return	0 1
Example	:CALCulate:MARKer1:CPSEarch ON

3.7.12.4 Peak Table

Open the peak table (in the lower window) which lists the peaks (with frequency and amplitude) that meet the peak search condition. Up to 30 peaks can be displayed in the table.

Command format	:CALCulate:MARKer:PEAK:TABLE :CALCulate:MARKer:PEAK:TABLE?
Instructions	Set/Query the switch of the peak value table
Parameter Type	Boolean
Parameter Range	ON OFF 0 1
Return	0 1
Example	:CALCulate:MARKer:PEAK:TABLE ON

Command format	:CALCulate:PEAK:TABLE?
Instructions	Get peak table data
Return	String
Example	:CALCulate:PEAK:TABLE?

3.7.12.5 Sort Order

Sort all signals in the peak table by the specific order.

Sort order based on the frequency / time (zero span) , ampt or delta to limit.

Command format	:CALCulate:MARKer:PEAK:SORT :CALCulate:MARKer:PEAK:SORT?
Instructions	Sets/gets the peak sorting basis
Parameter Type	Enumeration
Parameter Range	AMPT FREQ DELTA
Return	AMPT FREQ DELTA
Example	:CALCulate:MARKer:PEAK:SORT FREQ :CALCulate:MARKer:PEAK:SORT?

Command format	:CALCulate:MARKer:PEAK:SORT:ORDER :CALCulate:MARKer:PEAK:SORT:ORDER?
Instructions	Sets/Gets the peak sort type
Parameter Type	Enumeration
Parameter Range	ASC DEC
Return	ASC DEC
Example	:CALCulate:MARKer:PEAK:SORT:ORDER DEC :CALCulate:MARKer:PEAK:SORT:ORDER?

Command format	:CALCulate:MARKer:PEAK:TABLE:DTLimit :CALCulate:MARKer:PEAK:TABLE:DTLimit?
Instructions	Peak sorting based on limit selection
Parameter Type	Integer
Parameter Range	1-6

Return	1-6
Example	:CALCulate:MARKer:PEAK:TABLE:DTLimit 5 :CALCulate:MARKer:PEAK:TABLE:DTLimit?

Command format	:CALCulate:MARKer:PEAK:TABLE:DTLimit:STATe 0 1 :CALCulate:MARKer:PEAK:TABLE:DTLimit:STATe?
Instructions	Set/Query the switch of the peak value table
Parameter Type	Boolean
Parameter Range	ON OFF 0 1
Return	0 1
Example	:CALCulate:MARKer:PEAK:TABLE:DTLimit:STATe ON

3.8 Limit

The analyzer supports Pass/Fail test function. In this function, the measured curve will be compared with the pre-edited curve. If the related rules are met, the result is “**Pass**”, else the result is “**Fail**”.

3.8.1 Limit State

Enable or disable selected limit.

Command format	:CALCulate:LLINe[1] 2 3 4 5 6:STATe OFF ON 0 1 :CALCulate:LLINe[1] 2 3 4 5 6:STATe?
Instructions	Sets/gets the restricted state
Parameter Type	Boolean
Parameter Range	OFF ON 0 1
Return	0 1
Example	:CALCulate:LLINe1:STATe OFF

3.8.2 Limit Margin

Set the margin for selected limit.

When trace is between limit and margin, it will be displayed as **Fail Margin**.

Command format	:CALCulate:LLINe[1] 2 3 4 5 6:MARGin :CALCulate:LLINe[1] 2 3 4 5 6:MARGin?
Instructions	Sets/gets the limit margin value
Parameter Type	Float
Parameter Range	-100 dB ~ 100dB
Return	Float
Example	:CALCulate:LLINe2:MARGin 10 :CALCulate:LLINe2:MARGin? :CALCulate:LLINe2:MARGin:STATe 0

Command format	:CALCulate:LLINe[1] 2 3 4 5 6:MARGin:STATe :CALCulate:LLINe[1] 2 3 4 5 6:MARGin:STATe?
Instructions	Sets/gets the restricted state

Parameter Type	Boolean
Parameter Range	OFF ON 0 1
Return	0 1
Example	:CALCulate:LLINe1:MARGin:STATe OFF

3.8.3 Limit Type

Set the limit type as upper / lower. The limit 1,3,5 is default as the lower and 2,4,6 as the lower

Command format	:CALCulate:LLINe[1] 2 3 4 5 6:TYPE UPPer LOWer :CALCulate:LLINe[1] 2 3 4 5 6:TYPE?
Instructions	Sets/Gets the restriction type
Parameter Type	Enumeration
Parameter Range	UPPER LOWer
Return	Enumeration
Example	:CALCulate:LLINe1:TYPE LOWer

3.8.4 Limit Edit

Edit the properties of selected limit.

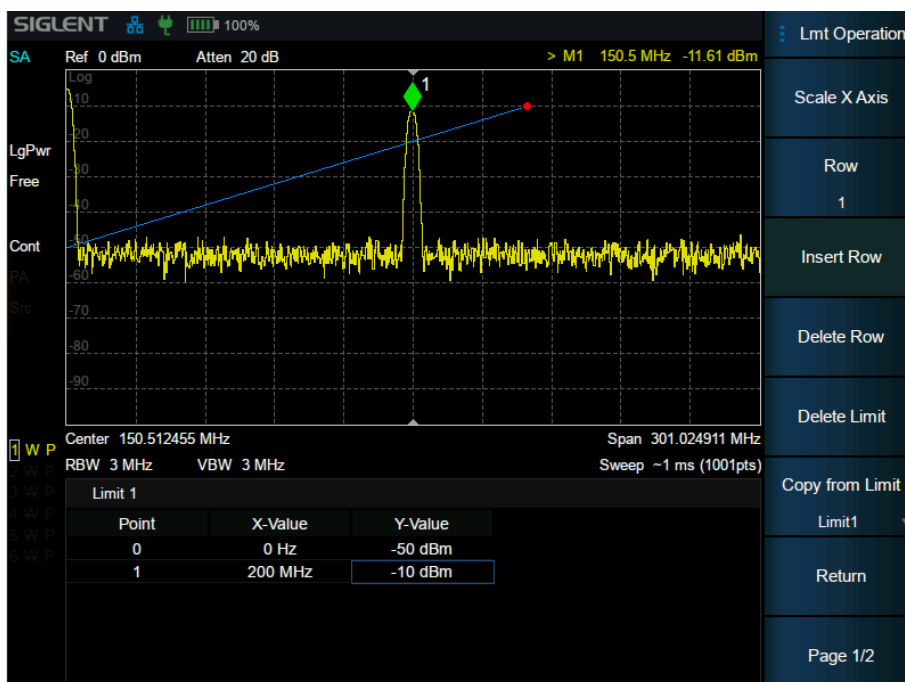

Figure 3-4 limit edit

Table 3-1 Limit1 Edit Menu

Function	Explanation
Type	Select upper or lower limit type. The default value is Upper.
Mode	Select limit line or limit point. The default value is Line. Set the number of the point to be edited if you selected the point type, and the range is 1 ~ 100.

Add point	Add a new point for editing.
X-axis	Edit the X-axis value (frequency or time) of the current point.
Amplitude	Edit the amplitude of the current point or line.
Del Point	Delete the point whose number is selected in Mode.
Del All	Delete all the points.
Save/Load	Save or load the limit file.
X Offset	Set offsets of X axis.
Y Offset	Set offsets of Y axis

Command format	:CALCulate:LLINe[1] 2 3 4 5 6:Offset:X :CALCulate:LLINe[1] 2 3 4 5 6:Offset:X?
Instructions	Set the limit point template frequency offset Gets the limit point template frequency offset
Parameter Type	Float
Parameter Range	0 ~ 26.5G
Return	Float
Example	:CALCulate:LLINe[1] 2 3 4 5 6:Offset:X 1MHz

Command format	:CALCulate:LLINe[1] 2 3 4 5 6:Offset:Y :CALCulate:LLINe[1] 2 3 4 5 6:Offset:Y?
Instructions	Sets the limit point template amplitude offset Gets the limiter template amplitude offset
Parameter Type	Float
Parameter Range	-350 dB~380 dB
Return	Float
Example	:CALCulate:LLINe5:Offset:Y -10

Command format	:CALCulate:LLINe[1] 2 3 4 5 6:DATA val1,val2 :CALCulate:LLINe[1] 2 3 4 5 6:DATA?
Instructions	Sets/gets restricted data (Clears previous data)
Parameter Type	val1 : frequency : Float, val2 : Ampl : Float
Parameter Range	val1 : related with Span val2 : -400 dBm~330 dBm
Return	val1 : frequency : Float, val2 : Ampl : Float
Example	:CALCulate:LLINe2:DATA 100,-20,200,-25 (add two points (100 , -20) and (200 , -25)) :CALC:LLINe1:DATA?

Command format	:CALCulate:LLINe[1] 2 3 4 5 6:ADD val1,val2 :CALCulate:LLINe[1] 2 3 4 5 6:POINT:DELeTe
Instructions	Add limit point Delete limit points
Parameter Type	val1 : frequency : Float,

Parameter Range	val2 : Ampl : Float val1 : related with Span val2 : -400 dBm~330 dBm
Example	:CALCulate:LLINe1:ADD 100,-20 :CALCulate:LLINe2:POINt:DELeTe 2

Command format	:CALCulate:LLINe[1] 2 3 4 5 6:DELeTe :CALCulate:LLINe:ALL:DELeTe
Instructions	Delete specified restrictions Delete all restrictions
Example	:CALCulate:LLINe1:DELeTe :CALCulate:LLINe:ALL:DELeTe

Command format	:CALCulate:LLINe[1] 2 3 4 5 6:TRACe :CALCulate:LLINe[1] 2 3 4 5 6:TRACe?
Instructions	Select the limit trace
Parameter Type	Integer
Parameter Range	1~6
Return	1~6
Example	:CALCulate:LLINe1:TRACe 3

Command format	:CALCulate:LLINe[1] 2 3 4 5 6:FREQUency:INTerpolate:TYPE :CALCulate:LLINe[1] 2 3 4 5 6:FREQUency:INTerpolate:TYPE?
Instructions	Set/Query the frequency difference type
Parameter Type	Enumeration
Parameter Range	LOG LIN
Return	LOG LIN
Example	:CALCulate:LLINe1:FREQUency:INTerpolate:TYPE LOG

Command format	:CALCulate:LLINe[1] 2 3 4 5 6:FREQUency:CMODE :CALCulate:LLINe[1] 2 3 4 5 6:FREQUency:CMODE?
Instructions	Set or query the frequency reference type
Parameter Type	Enumeration
Parameter Range	FIXed RELAtive
Return	FIXed RELAtive
Example	:CALCulate:LLINe2:FREQUency:CMODE FIX

Command format	:CALCulate:LLINe[1] 2 3 4 5 6:AMPLitude:INTerpolate:TYPE :CALCulate:LLINe[1] 2 3 4 5 6:AMPLitude:INTerpolate:TYPE?
Instructions	Set or query the range difference type
Parameter Type	Enumeration
Parameter Range	LOG LIN
Return	LOG LIN
Example	:CALCulate:LLINe1: AMPLitude:INTerpolate:TYPE LOG

Command format	:CALCulate:LLINe[1] 2 3 4 5 6: AMPLitude:CMODE :CALCulate:LLINe[1] 2 3 4 5 6: AMPLitude:CMODE?
-----------------------	---

Instructions	Set or query the amplitude reference type
Parameter Type	Enumeration
Parameter Range	FIXed RELAtive
Return	FIXed RELAtive
Example	:CALCulate:LLINe2: AMPLitude:CMODE FIX

Command format	:CALCulate:LLINe[1] 2 3 4 5 6: COPY :CALCulate:LLINe[1] 2 3 4 5 6: COPY?
Instructions	Copy the limit
Parameter Type	Integer
Parameter Range	1~6
Return	1~6
Example	:CALCulate:LLINe2: COPY 5

Command format	:CALCulate:LLINe[1] 2 3 4 5 6: BUILd :CALCulate:LLINe[1] 2 3 4 5 6: BUILd?
Instructions	Fitting a trace
Parameter Type	Integer
Parameter Range	1~6
Return	1~6
Example	:CALCulate:LLINe2: BUILd 1 :CALCulate:LLINe2: BUILd?

3.8.5 Limit Test

Enable or disable the limit test function.

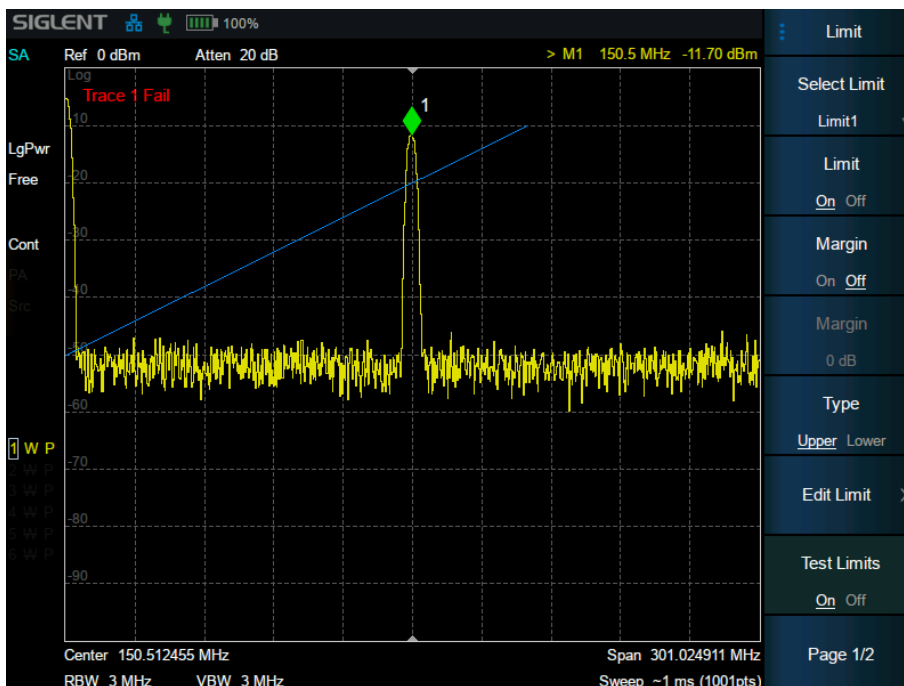

Figure 3-5 test results

Command format	:CALCulate:LLINe:TEST :CALCulate:LLINe:TEST?
Instructions	Sets/gets the status of the test switch
Parameter Type	Boolean
Parameter Range	OFF ON 0 1
Return	0 1
Example	:CALCulate:LLINe:TEST 1

Command format	:CALCulate:LLINe[1] 2 3 4 5 6:FAIL?
Instructions	Query limit test results.
Return	0 1
Example	:CALCulate:LLINe2:FAIL 1

3.8.6 Setup

Fail to stop

Turn on or off the Fail to stop function. If the function is on, the analyzer will stop sweep and retain the test result when the test result is "Fail".

Buzzer

Turn on or off the buzzer. When the buzzer is on, it beeps when the test result is "Fail".

Command format	:CALCulate:LLINe:CONTrol:BEEP :CALCulate:LLINe:CONTrol:BEEP?
Instructions	Sets/gets the restricted buzzer
Parameter Type	Boolean
Parameter Range	OFF ON 0 1
Return	0 1
Example	:CALCulate:LLINe:CONTrol:BEEP OFF

Command format	:CALCulate:LLINe:FAIL:STOP :CALCulate:LLINe:FAIL:STOP?
Instructions	The set/query limit test stops if it fails
Parameter Type	Boolean
Parameter Range	OFF ON 0 1
Return	0 1
Example	:CALCulate:LLINe:FAIL:STOP OFF

3.9 Meas & Meas Setup

Provide optional measurement functions. When activated, the screen will be divided into two parts. The above part is the measure screen which displays traces, and the other part is used to display measurement results.

3.9.1 Swept SA

The Swept SA measurement lets you perform “traditional” Spectrum Analysis, that is, Swept and Zero Span measurements, as well as “Swept FFT” analysis (FFT analysis presented as though it were swept).

3.9.1.1 Average Type

Choose one of the following averaging types: log power (video), power (RMS), or voltage averaging. When trace average is on, the average type is shown on the left side of the display.

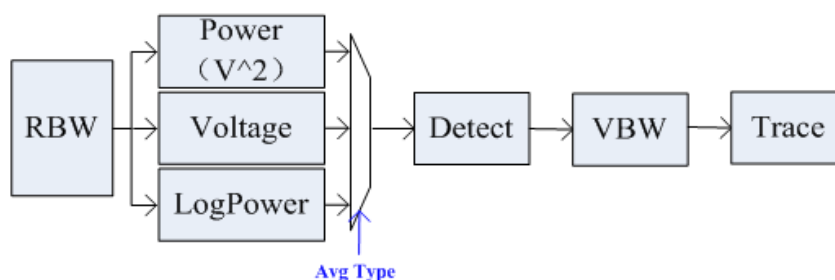

Figure 3-6 Average Type

- **Log Power**

Select the logarithmic (decibel) scale for all filtering and averaging processes. This scale is "Video" because it is the most common display and analysis scale for the video signal within analyzer. This scale is excellent for finding Sine/CW signals near noise.

- **Power Average**

In this average type, all filtering and averaging processes work on the power (the square of the magnitude) of the signal, instead of its log or envelope voltage. This scale is best for real-time power measurement of complex signals.

- **Voltage Average**

In this Average type, all filtering and averaging processes work on the voltage of the envelope of the signal. This scale is suitable for observing rise and fall behavior of AM or pulse-modulated signals such as radar and TDMA transmitters.

Command format	<code>[:SENSe]:AVERage:TYPE LOGPower POWER VOLTage</code> <code>[:SENSe]:AVERage:TYPE?</code>
Instructions	Set/Query the average type
Parameter type	Enumeration
Parameter Range	LOGPower POWER VOLTage
Return	Enumeration : LOGP POW VOLT
Example	AVERage:TYPE VOLTage

Command format	[[:SENSe]:AVERage:TYPE:AUTO 0 1 ON OFF [:SENSe]:AVERage:TYPE:AUTO?
Instructions	Set/query the average type automatically
Parameter type	Boolean
Parameter Range	OFF ON 0 1
Return	0 1
Example	:AVERage:TYPE:AUTO 1

3.9.1.2 Average/Hold Number

Sets the terminal count number N for Average, Max Hold and Min Hold trace types. This number is an integral part of how the average trace is calculated. Basically, increasing N results in a smoother average trace.

Command format	[[:SENSe]:AVERage:TRACe[1] 2 3 4 5 6:COUNT [:SENSe]:AVERage:TRACe[1] 2 3 4 5 6:COUNT?
Instructions	Sets/gets the average number of traces
Parameter type	Integer
Parameter Range	1 ~ 999
Return	Integer
Example	:AVERage:TRACe1:COUNT 10

Command format	[[:SENSe]:AVERage:TRACe[1] 2 3 4 5 6? [:SENSe]:AVERage:TRACe[1] 2 3 4 5 6:CLEar
Instructions	The current average number of times the trace has been obtained Restart average
Example	:AVERage:TRACe2 ? :AVERage:TRACe2:CLEar

3.9.1.3 Tune & Radio

- **Demod(AM/FM)**

Sets the demodulation type of AM, FM or OFF demod. Default setting is OFF demod.

When AM(or FM) demodulation is turned on, the system automatically opens a cursor to position it at the center frequency, and perform AM (or FM) demodulation for this frequency point.

This machine is equipped with a headphone jack, through which demodulation signal can be output in audio mode. Audio frequency represents the frequency of the modulated signal, and the intensity of audio indicates the amplitude of the modulated signal.

- **Earphone**

Set the headset status/volume. When the headset is turned on, the voice of the modulation signal can be heard through the headset during the demodulation process. The headset is disabled by default. You can set the volume of the headset by volume.

- **Demodulation time**

Set the dwell time of signal demodulation after each sweep. Longer dwell time will benefit continuous demodulation signal.

If the headset is turned on, the voice of the demodulated signal will be heard through the headset during this period.

Command format	[[:SENSe]:DEMod AM FM OFF [:SENSe]:DEMod?
Instructions	Sets the demodulation mode Gets the demodulation mode
Parameter type	Enumeration
Parameter Range	AM : Amplitude modulation FM : Frequency modulation OFF
Return	Enumeration: AM FM OFF
Example	:DEMod AM

Command format	[[:SENSe]:DEMod:EPHone OFF ON 0 1 [:SENSe]:DEMod:EPHone?
Instructions	Switch the headset
Parameter type	Boolean
Parameter Range	OFF ON 0 1
Return	0 1
Example	:DEMod:EPHone ON

Command format	[[:SENSe]:DEMod:VOLume [:SENSe]:DEMod:VOLume?
Instructions	Adjust the volume
Parameter type	Integer
Parameter Range	0 ~ 10
Return	Integer
Example	:DEMod:VOLume 10

Command format	[[:SENSe]:DEMod:TIME [:SENSe]:DEMod:TIME?
Instructions	Set the demodulation time Get demodulation time
Parameter type	Float , unitms , us , s
Parameter Range	5 ms ~1000 s
Return	Float , units
Example	DEMod:TIME 5 ms

3.9.1.4 Automatic coupling

Auto coupling instantly sets all auto/manual functions to auto. The automatic coupling action is limited to the current measurement. It does not affect other measurements in the mode.

In the automatic state, the automatic/manual functions are referred to as "coupled", which means that

their values will change based on changes made to other values in the measurement. This helps ensure accurate measurements and optimal dynamic range. Automatic coupling is a just-in-time action feature that, when it is performed, all automatic/manual controls for the current measurement are set to automatic and all measurement settings coupled to automatic/manual parameters are automatically set to their best values.

Command format	:COUPlE:ALL
Instructions	Automatic coupling
Example	:COUPlE:ALL

3.9.1.5 Display line

The amplitude line can be used as a reference for the amplitude readout or as a threshold condition for the peak display in the peak table.

The frequency line can be used as a reference for frequency readout.

Command format	:DISPlay:WINDow:TRACe:Y:DLINe :DISPlay:WINDow:TRACe:Y:DLINe?
Instructions	Sets/gets the amplitude display line
Parameter type	Float
Return	Float
Example	:DISPlay:WINDow:TRACe:Y:DLINe -40

Command format	:DISPlay:WINDow:TRACe:Y:DLINe:STATe :DISPlay:WINDow:TRACe:Y:DLINe:STATe?
Instructions	Set/get amplitude display line automatically
Parameter type	Boolean
Parameter Range	OFF ON 0 1
Return	0 1
Example	:DISPlay:WINDow:TRACe:Y:DLINe:STATe 1

Command format	:DISPlay:WINDow:TRACe:X:FLINe :DISPlay:WINDow:TRACe:X:FLINe?
Instructions	Set/Obtain the frequency display line
Parameter type	Float
Return	Float
Example	:DISPlay:WINDow:TRACe:X:FLINe 100e6

Command format	:DISPlay:WINDow:TRACe:X:FLINe:STATe :DISPlay:WINDow:TRACe:X:FLINe:STATe?
Instructions	Set/get frequency display line automatically
Parameter type	Boolean
Parameter Range	OFF ON 0 1
Return	0 1
Example	:DISPlay:WINDow:TRACe:X:FLINe:STATe 1

3.9.1.6 Global

The global center frequency causes the current center frequency to act on other measurements / sweep.

Command format	:INSTrument:COUPlE:FREQUency:CENTer :INSTrument:COUPlE:FREQUency:CENTer?
Instructions	Enable/disable the global center frequency
Parameter Type	Boolean
Parameter Range	ON OFF 0 1
Return	0 1
Example	:INSTrument:COUPlE:FREQUency:CENTer 0 :INSTrument:COUPlE:FREQUency:CENTer?

3.9.1.7 Source

There are two Source type:

CW:

CW Freq: Set the Independent source frequency, which synchronizes the SA receiver's center frequency setting, so the signal is displayed in the center of the screen;

CW Level: Enter a number from -40 dBm to 0 dBm. The source power is displayed flat over the frequency range.

CW offset:

Offset to CF : The distance the signal is offset by IF;

CW Offset Level : Signal peak amplitude offset.

Command format	[[:SENSe]:SOURce:STATe 0 1 ON OFF [[:SENSe]:SOURce:STATe?
Instructions	Set/Query the source state
Parameter type	Boolean
Parameter Range	OFF ON 0 1
Return	0 1
Example	:SOURce:STATe 0 :SOURce:STATe ?

Command format	[[:SENSe] :SOURce:TYPE CW [[:SENSe] :SOURce:TYPE?
Instructions	Set/Query the source type
Parameter type	Enumeration
Parameter Range	CW CWC
Return	Enumeration CW CWC
Example	:SOURce:TYPE CW :SOURce:TYPE?

Command format	[[:SENSe]:SOURce: CW:FREQuency [:SENSe]:SOURce: CW:FREQuency?
Instructions	Sets the CW FREQ Gets the CW FREQ
Parameter Type	Float
Parameter Range	100KHz~7.5GHz
Return	Float
Example	:SOURce: CW:FREQuency 10MHz :SOURce: CW:FREQuency?

Command format	[[:SENSe]:SOURce: CW:POWer [:SENSe]:SOURce: CW:POWer?
Instructions	Sets the CW POWer Gets the CW POWer
Parameter Type	Float
Parameter Range	-40 dB~0 dB
Return	Float
Example	:SOURce: CW:POWer -10 :SOURce: CW:POWer?

Command format	[[:SENSe]:SOURce: CWCoupled: FREQuency: OFFSet [:SENSe]:SOURce: CWCoupled: FREQuency: OFFSet?
Instructions	Sets the offset to CF Gets the offset to CF
Parameter Type	Float
Parameter Range	-100GHz~100GHz
Return	Float
Example	:SOURce: CWCoupled: FREQuency: OFFSet -10 :SOURce: CWCoupled: FREQuency: OFFSet?

Command format	[[:SENSe]:SOURce: CWCoupled: POWer [:SENSe]:SOURce: CWCoupled: POWer?
Instructions	Sets the CW Offset POWer Gets the CW Offset POWer
Parameter Type	Float
Parameter Range	-40 dB~0 dB
Return	Float
Example	:SOURce: CWCoupled: POWer -10 :SOURce: CWCoupled: POWer?

3.9.2 Channel Power

Measure the power and power density within the specified channel bandwidth. When this function is enabled, the span and resolution bandwidth are automatically adjusted to smaller values. Select **Channel Power** and press **Meas Setup** to set the corresponding parameters.

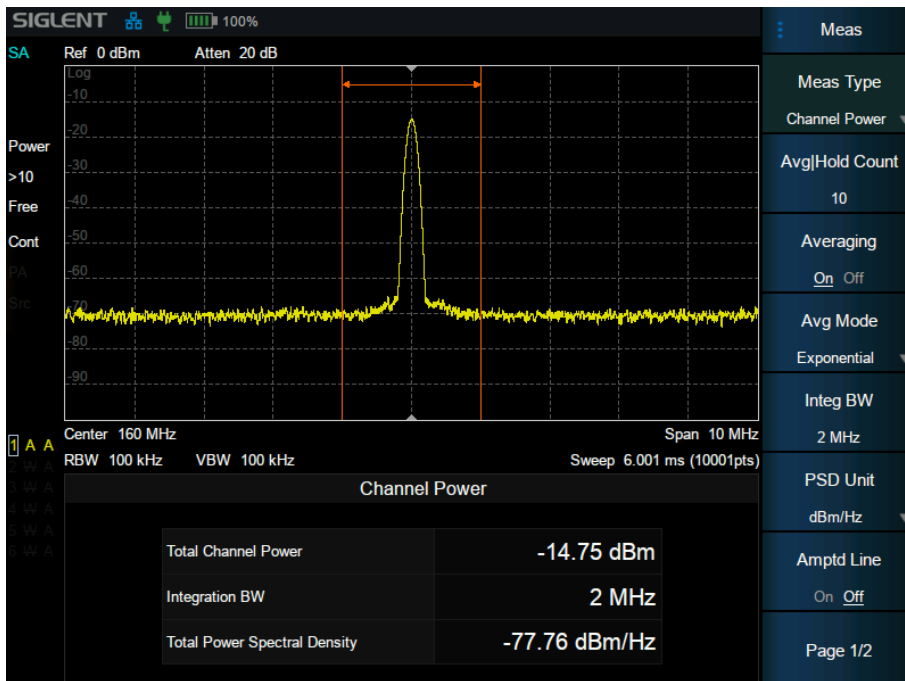

Figure 3-7 Channel Power

Measurement Results: Channel power and power spectral density.

- Channel Power: Power within the integration bandwidth.
- Power Spectral Density: Power (in dBm/Hz) normalized to 1Hz within the integration bandwidth.

Measurement Parameters: Center Freq, Integration BW, Span, Span power.

Command format	:CHPower:MEASure:CHPower? :CHPower:MEASure:CHPower:CHPower? :CHPower:MEASure:CHPower:DENSity?
Instructions	Read channel power and power spectral density
Return	Float , Channel power unit: dBm Float , A unit of spectral density of power :dBm/Hz
Example	:CHPower:MEASure:CHPower?

3.9.2.1 Average Mode

Select the type of control used for the averaging function. This determines the average operation after the specified number of data acquisitions (average count) has been reached. Options include:

Exponential :

The measure average operation continuously calculates a weighted average for each index using a specified number of averages.

Repeat :

Each time the specified average is reached, the measurement resets the average counter.

Command format	<code>[:SENSe]:CHPower:AVERage:TCONtrol</code> <code>[:SENSe]:CHPower:AVERage:TCONtrol?</code>
Instructions	Sets/gets the average mode
Parameter type	Enumeration
Parameter Range	EXPOntialr REPEat
Return	EnumerationEXPOntialr REPEat
Example	:CHPower:AVERage:TCONtrol REPEat

3.9.2.2 Integration BW

Set the frequency width of the channel to be tested and the power of the channel is the power integral within this bandwidth. You can use the numeric keys, knob or direction keys to modify this parameter.

Command format	<code>[:SENSe]:CHPower:BWIDth:INTEgration</code> <code>[:SENSe]:CHPower:BWIDth:INTEgration?</code>
Instructions	Sets/gets the integral bandwidth
Parameter type	Float , unitHz , kHz , MHz , GHz
Return	Float m unitHz
Example	:CHPower:BWIDth:INTEgration 1.0 GHz

Command format	<code>[:SENSe]:CHPower:FREQuency:SPAN:POWer</code>
Instructions	Sets the value of channel sweep to the integral bandwidth
Example	:CHPower:FREQuency:SPAN:POWer

3.9.2.3 PSD Unit

Select power spectral density unit, optional dBm/Hz , dBm/MHz.

Command format	<code>:UNIT:CHPower:POWer:PSD</code> <code>:UNIT:CHPower:POWer:PSD?</code>
Instructions	Select the power spectral density unit
Parameter type	Enumeration
Parameter Range	DBMHZ DBMMHZ
Return	DBMHZ DBMMHZ
Example	:UNIT:CHPower:POWer:PSD DBMHZ :UNIT:CHPower:POWer:PSD?

3.9.3 ACPR

Measure the power of the main channel and adjacent channels as well as the power difference between the main channel and each of the adjacent channels. When this function is enabled, the span and resolution bandwidth of the analyzer are adjusted to smaller values automatically.

Select **ACPR** and press **Meas Setup** to set the corresponding parameters.

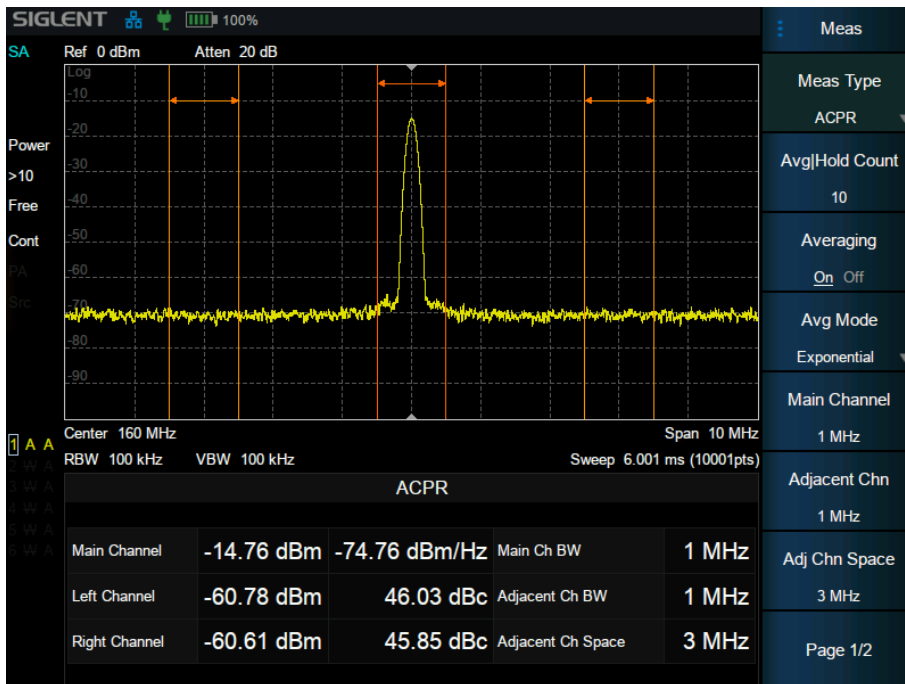

Figure 3-8 ACPR

Measurement Results: Main CH Power, Left channel power and Right channel power.

- Main CH Power: Displays the power within the bandwidth of the main power
- Left channel power : Displays the power of left channel and the power difference between the left channel and the main channel (in dBc)
- Right channel power: Display the power of the right channel and the power difference between the right channel and the main channel(in dBc)

Measurement parameter: Center frequency, main channel bandwidth, adjacent channel bandwidth and channel spacing

Command format	:MEASure:ACPRatio:ACPower:MAIN? :MEASure:ACPRatio:LOWer:POWER? :MEASure:ACPRatio:UPPer:POWER?
Instructions	Get the main channel power Obtain low and high frequency adjacent channel power
Return	Float , unitdBm
Example	:MEASure:ACPRatio:ACPower:MAIN?

Command format	:MEASure:ACPRatio:LOWer? :MEASure:ACPRatio:UPPer?
Instructions	Obtain the low frequency/high frequency adjacent channel power ratio
Return	Float , unitdBm
Example	:MEASure:ACPRatio:LOWer?

3.9.3.1 Average Mode

Select the type of control used for the averaging function. This determines the average operation after the specified number of data acquisitions (average count) has been reached. Options include:

Exponentialr :

The measure average operation continuously calculates a weighted average for each index using a specified number of averages.

Repeat :

Each time the specified average is reached, the measurement resets the average counter.

Command format	[[:SENSe]:ACPower:AVERage:TCONtrol [:SENSe]:ACPower:AVERage:TCONtrol?
Instructions	Setting average Mode Get average pattern
Parameter type	Enumeration
Parameter Range	EXPOntialr REPEat
Return	EnumerationEXPOntialr REPEat
Example	:ACPower:AVERage:TCONtrol REPEat

3.9.3.2 Main Channel

Set the bandwidth of the main channel and the power of the main channel is the power integral within this bandwidth.

Command format	[[:SENSe]:ACPRatio:BWIDth:INTegration [:SENSe]:ACPRatio:BWIDth:INTegration?
Instructions	Set the bandwidth of the adjacent channel Obtain the bandwidth of the adjacent channel
Parameter type	Float , unitHz , kHz , MHz , GHz
Parameter Range	related with Span
Return	Float , unitHz
Example	:ACPRatio:BWIDth:INTegration 20 MHz

3.9.3.3 Adjacent Chn

Set the frequency width of the adjacent channels.

The adjacent channel bandwidth is related to the main channel bandwidth.

Command format	[[:SENSe]:ACPRatio:OFFSet:BWIDth[:INTegration] [:SENSe]:ACPRatio:OFFSet:BWIDth[:INTegration]?
Instructions	Set the main channel bandwidth Get the main channel bandwidth
Parameter type	Float , unitHz , kHz , MHz , GHz
Parameter Range	related with Span
Return	Float, unitHz
Example	:ACPRatio:OFFSet:BWIDth 20 MHz

3.9.3.4 Adj Chn space

Set the difference between the center frequency of the main channel and the center frequency of the adjacent channels.

Adjusting this parameter will also adjust the distance between the upper/lower channel and the main channel.

Command format	<code>[[:SENSE]:ACPRatio:OFFSet[:FREQUENCY]]</code> <code>[[:SENSE]:ACPRatio:OFFSet[:FREQUENCY]]?</code>
Instructions	Set the adjacent channel interval Gets the adjacent channel interval
Parameter type	Float , unitHz , kHz , MHz , GHz
Parameter Range	related with Span
Return	Float, unitHz
Example	:ACPRatio:OFFSet 20 MHz

3.9.3.5 PSD Unit

Select power spectral density unit, optional is dBm/Hz , dBm/MHz.

Command format	<code>:UNIT: ACPRatio:POWer:PSD</code> <code>:UNIT: ACPRatio:POWer:PSD?</code>
Instructions	Select the power spectral density unit
Parameter Type	Enumeration
Parameter Range	DBMHZ DBMMHZ
Return	DBMHZ DBMMHZ
Example	:UNIT: ACPRatio:POWer:PSD DBMHZ :UNIT: ACPRatio:POWer:PSD?

3.9.4 OBW

Integrates the power within the whole span and calculates the bandwidth occupied by this power according to the specified power ratio. The OBW function also indicates the difference (namely "Transmit Freq Error") between the center frequency of the channel under measurement and the center frequency of the analyzer. Select **Occupied BW** and press **Meas Setup** to set the corresponding parameters.

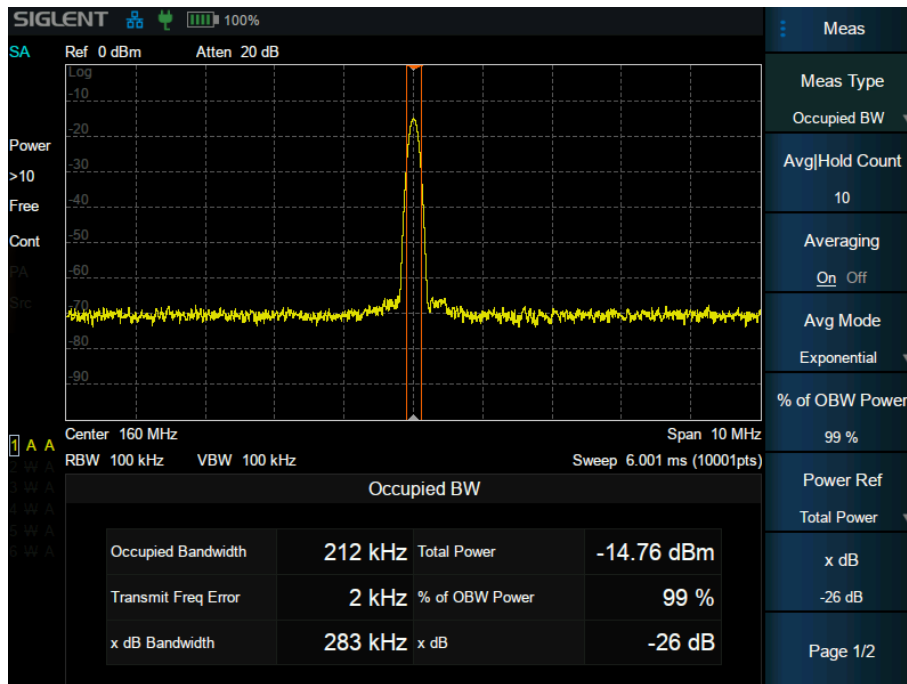

Figure 3-9 OBW

Measurement Results: occupied bandwidth and transmit frequency error.

- **Occupied Bandwidth:** Integrates the power within the whole span and then calculates the bandwidth occupied by the power according to the specified power ratio.
- **Transmit Frequency Error:** The difference between the center frequency of the channel and the center frequency of the analyzer.

Command format	:MEASure:OBWidth? :MEASure:OBWidth:OBWidth? :MEASure:OBWidth:CENTRoid?
Instructions	Read bandwidth and bandwidth center
Return	Float , unitHz
Example	:MEASure:OBW?

Command format	:MEASure:OBWidth:OBWidth:FERRor?
Instructions	Get transmission frequency error
Return	Float , unitHz
Example	:MEASure:OBWidth:OBWidth:FERRor?

3.9.4.1 Average Mode

Select the type of control used for the averaging function. This determines the average operation after the specified number of data acquisitions (average count) has been reached. Options include:

Exponential :

The measure average operation continuously calculates a weighted average for each index using a specified number of averages.

Repeat :

Each time the specified average is reached, the measurement resets the average counter.

Command format	[[:SENSe]:OBWidth:AVERage:TCONtrol [:SENSe]:OBWidth:AVERage:TCONtrol?
Instructions	Sets/gets average mode
Parameter type	Enumeration
Parameter Range	EXPOntialr REPEat
Return	EXPOntialr REPEat
Example	:OBWidth:AVERage:TCONtrol REPE

3.9.4.2 Power ratio

Specifies the percentage of total power measured within occupied bandwidth for the current measurement.

Command format	[[:SENSe]:OBWidth:PERCent [:SENSe]:OBWidth:PERCent?
Instructions	Set the bandwidth usage percentage Gets the percentage of occupied bandwidth
Parameter type	Float
Parameter Range	10~99.99
Return	Float
Example	:OBW:PERCent 50

3.9.4.3 Power Reference

Select the power reference type.

- Total Power: The measurement result will display the power in the entire span.
- OBW power: The measurement result will display the occupied power.

Command format	[[:SENSe]:OBWidth:PREFERENCE [:SENSe]:OBWidth:PREFERENCE?
Instructions	Setting power Reference Obtaining power reference
Parameter type	Enumeration TPOW OBWPower
Return	Enumeration
Example	:OBWidth:PREFERENCE TPOW

3.9.4.4 x dB

Sets the x dB value used for the "x dB Bandwidth" result, which measures the bandwidth between two points on the signal that are x dB below the highest signal point in the OBW range.

Command format	[[:SENSe]:OBWidth:XDB [:SENSe]:OBWidth:XDB?
Instructions	Set the bandwidth USAGE dBc value Obtain the occupied bandwidth dBc value
Parameter type	Float
Parameter Range	0.1~100
Return	Float
Example	:OBWidth:XDB 3

3.9.4.5 Power integration mode

Set the power integration mode to Normal or From-Center.

Command format	[[:SENSe]:OBWidth:INTegration[:METHod] [:SENSe]:OBWidth:INTegration[:METHod]?
Instructions	Set integral type Get integral type
Parameter type	Enumeration NORMAl ICENter
Return	Enumeration
Example	:OBWidth:INTegration ICENter

3.9.5 T-Power

The system enters Zero span and calculates the power within the time domain. The types of powers available include Peak, Average and RMS. Select **T-Power** and press **Meas Setup** to set the corresponding parameters.



Figure 3-10 T-Power

Measurement Results: T-Power

T-Power: The power of the signal from the start line to the stop line.

Measurement Parameter: Center frequency, start line, stop line.

Command format	:MEASure:TPOWer?
Instructions	Read time domain power
Return	Float , unitdBm
Example	:MEASure:TPOWer?

3.9.5.1 Average Mode

Select the type of control used for the averaging function. This determines the average operation after the specified number of data acquisitions (average count) has been reached. Options include:

Exponential :

The measure average operation continuously calculates a weighted average for each index using a specified number of averages.

Repeat :

Each time the specified average is reached, the measurement resets the average counter.

Command format	[:SENSe]: TPOWer:AVERAge:TCONtrol [:SENSe]: TPOWer:AVERAge:TCONtrol?
Instructions	Sets/gets average mode
Parameter Type	Enumeration
Parameter Range	EXPOntial REPEat
Return	EXPOntial REPEat
Example	:TPOWer:AVERAge:TCONtrol REPE

3.9.5.2 Center Frequency

Set the center frequency, this center frequency which is the same with the center frequency of the analyzer. Modifying this parameter will change the center frequency of the analyzer.

Command format	[:SENSe]:TPOWer:FREQuency:CENTer [:SENSe]:TPOWer:FREQuency:CENTer?
Instructions	Set the time domain power center frequency Obtain the time domain power center frequency
Parameter type	Float , unitHz , kHz , MHz , GHz
Parameter Range	related with Span
Return	Float , unitHz
Example	:TPOWer:FREQuency:CENTer 15kHz

3.9.5.3 Start line

Set the left margin (in time unit) of T-Power measurement. The data calculated under this measurement is between the start line and stop line.

Command format	[:SENSe]:TPOWer:LLIMit [:SENSe]:TPOWer:LLIMit?
Instructions	Set/Query the time domain power measurement start line
Parameter type	Float , unit : s
Parameter Range	0 ~ 1000 s
Return	Float , time unit : s
Example	:TPOWer:LLIMit 100

3.9.5.4 Stop line

Set the right margin (in time unit) of T-Power measurement. The data calculated under this measurement is between the start line and stop line.

Command format	[:SENSe]:TPOWer:RLIMit [:SENSe]:TPOWer:RLIMit?
Instructions	Set/Query the time domain power measurement stop line
Parameter type	Float , unit : s
Parameter Range	0 ~ 1000 s
Return	Float , time unit : s
Example	:TPOWer:RLIMit 50 s

3.9.6 TOI

Automatic measurement of IP3 (Third order Intercept Point), including the power of fundamental wave and the Third order in the power, and calculate the adjustable Intercept Point.

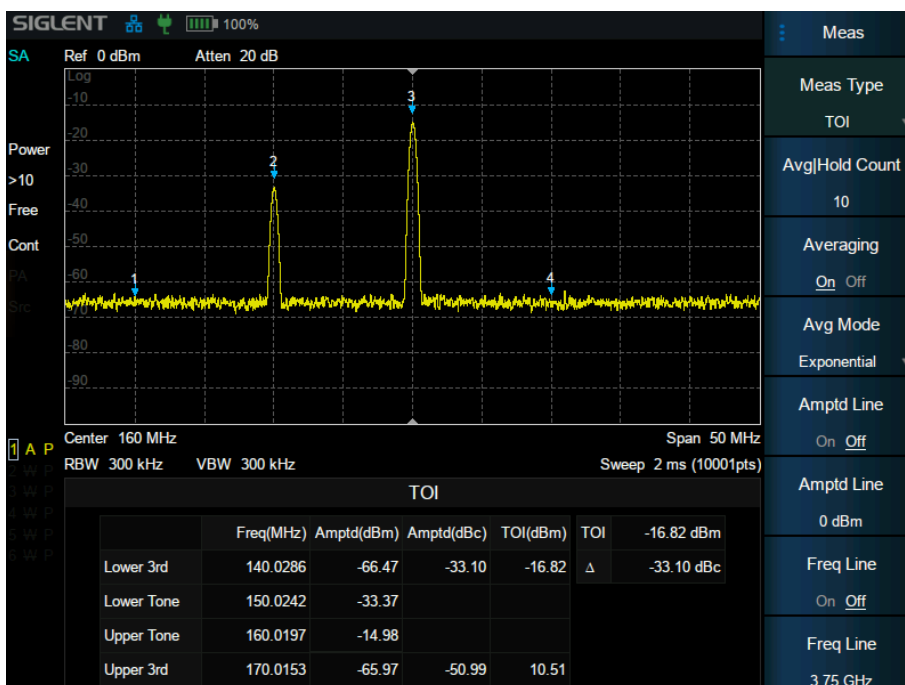

Figure 3-11 TOI

TOI is an automatic measurement. There are no user controlled parameters.

Command format	:MEASure:TOI?
Instructions	Read the measurement results of third-order intermodulation distortion Returns the following values separated by commas in scientific count form: Lower Tone frequency (Hz), amplitude, Upper Tone frequency (Hz), amplitude, TOI(Lower 3rd) frequency (Hz), amplitude, third-order intermodulation cutoff (Intercept), High frequency TOI(Upper 3rd) frequency (Hz), amplitude, third-order intermodulation cut-off point (Intercept).
Return	Float
Example	:MEASure:TOI?

Command format	:MEASure:TOI:IP3?
Instructions	Read the smaller value in the third-order intermodulation cutoff (Intercept) of low frequency TOI(Lower 3rd) and high frequency TOI(Upper 3rd)
Return	Float
Example	:MEASure:TOI:IP3?

3.9.6.1 Average Mode

Select the type of control used for the averaging function. This determines the average operation after the specified number of data acquisitions (average count) has been reached. Options include:

Exponential :

The measure average operation continuously calculates a weighted average for each index using a specified number of averages.

Repeat :

Each time the specified average is reached, the measurement resets the average counter.

Command format	[:SENSe]:TOI:AVERAge:TCONtrol [:SENSe]:TOI:AVERAge:TCONtrol?
Instructions	Sets/gets average mode
Parameter Type	Enumeration
Parameter Range	EXPOntial REPEat
Return	EXPOntial REPEat
Example	:TOI:AVERAge:TCONtrol REPE

3.9.7 Spectrum Monitor

Display the power of the swept spectrum as an intensity color map commonly referred to as a waterfall chart. Select **Spectrum Monitor** and press **Meas Setup** to set the corresponding parameters.

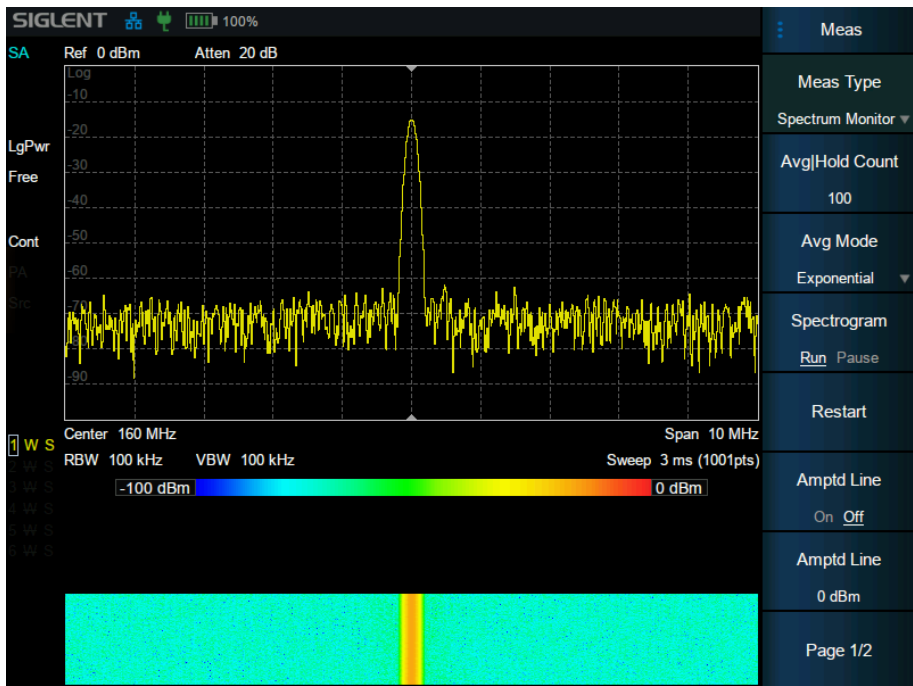

Figure 3-12 Spectrum Monitor

Display the power of spectrum of successive scans as a color map. Also call a waterfall chart.

Measurement Parameter: Spectrogram, Restart.

Spectrogram: Sets the meas state of spectrum monitor.

Restart: clear the measurement and then restart it.

Command format	[[:SENSE]:SPECTrogram:STATE [:SENSE]:SPECTrogram:STATE?
Instructions	Set the spectrum to monitor the operating status Obtain spectrum to monitor operating status
Parameter type	Boolean
Parameter Range	0 1
Return	0 1
Example	[[:SENSE]:SPECTrogram:STATe 0 [:SENSE]:SPECTrogram:STATe?

Command format	[[:SENSE]:SPECTrogram:REStart
Instructions	Spectrum rescanning
Parameter type	Boolean
Parameter Range	0 1
Return	0 1
Example	[[:SENSE]:SPECTrogram:REStart

3.9.7.1 Average Mode

Select the type of control used for the averaging function. This determines the average operation after the specified number of data acquisitions (average count) has been reached. Options include:

Exponential :

The measure average operation continuously calculates a weighted average for each index using a specified number of averages.

Repeat :

Each time the specified average is reached, the measurement resets the average counter.

Command format	[[:SENSe]: SPECTrogram:AVERage:TCONtrol [:SENSe]: SPECTrogram:AVERage:TCONtrol?
Instructions	Sets/gets average mode
Parameter Type	Enumeration
Parameter Range	EXPOntialr REPEat
Return	EXPOntialr REPEat
Example	:SPECTrogram:AVERage:TCONtrol REPE

3.9.8 CNR

Measure the power of the carrier and noise of the specified bandwidth and their ratio. Select **CNR** and press **Meas Setup** to set the corresponding parameters.

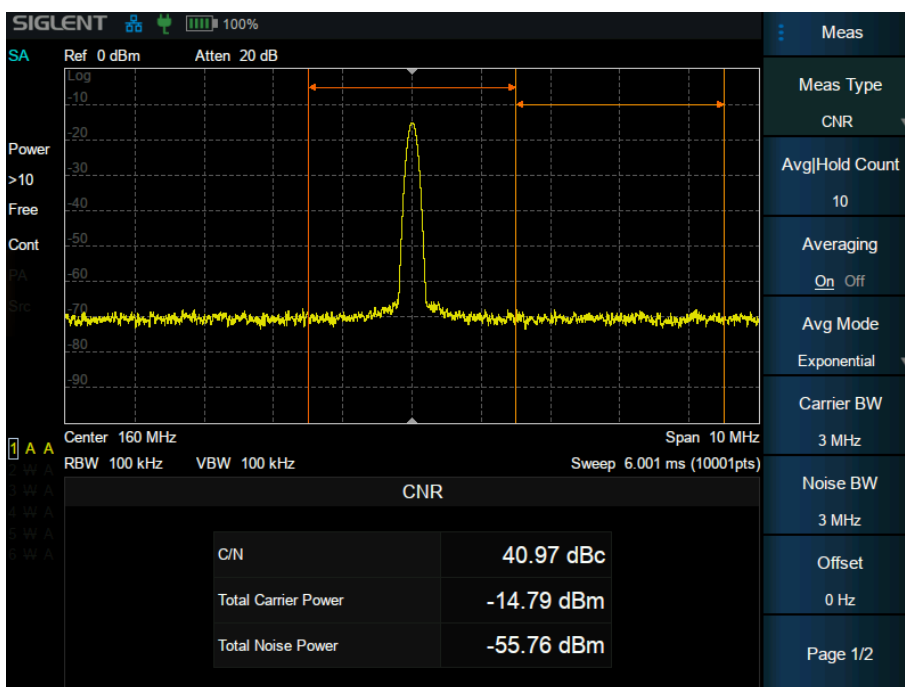

Figure 3-13 CNR

Measurement Results: C/N, Carrier Power, Noise Power.

C/N: the ratio of Carrier Power to Noise Power.

Carrier Power: the total power of the carrier bandwidth.

Noise Power: the total power of the selected noise bandwidth.

Command format	:CNRatio:MEASure:CNRatio? :CNRatio:MEASure:CNRatio:CARRier? :CNRatio:MEASure:CNRatio:NOISe?
Instructions	Obtain the SNR Acquisition of carrier power Get noise power
Return	Float
Example	:CNRatio:MEASure:CNRatio?

3.9.8.1 Average Mode

Select the type of control used for the averaging function. This determines the average operation after the specified number of data acquisitions (average count) has been reached. Options include:

Exponential:

The measure average operation continuously calculates a weighted average for each index using a specified number of averages.

Repeat :

Each time the specified average is reached, the measurement resets the average counter.

Command format	[:SENSe]:CNRatio:AVERage:TCONtrol [:SENSe]:CNRatio:AVERage:TCONtrol?
Instructions	Sets/gets average mode
Parameter Type	Enumeration
Parameter Range	EXPOntial REPEat
Return	EXPOntial REPEat
Example	:CNRatio:AVERage:TCONtrol REPE

3.9.8.2 Carrier BW

Set the bandwidth of the carrier to be measured.

Command format	[:SENSe]:CNRatio:BANDwidth:INTegration [:SENSe]:CNRatio:BANDwidth:INTegration?
Instructions	Sets/gets bandwidth of the carrier
Parameter Type	Float , Unit: Hz , kHz , MHz , GHz
Parameter Range	100 Hz~7.5 GHz
Return	Float , Unit: Hz
Example	INSTRument:CNRatio:MEASure CNR :CNRatio:BANDwidth:INTegration 20 MHz

3.9.8.3 Noise BW

Set the bandwidth of the noise to be measured.

Command format	[[:SENSe]:CNRatio:BANDwidth:NOISe [:SENSe]:CNRatio:BANDwidth:NOISe?
Instructions	Sets/gets bandwidth of the noise
Parameter Type	Float , Unit: Hz , kHz , MHz , GHz
Parameter Range	100 Hz~3.2 GHz
Return	Float , Unit: Hz
Example	:ACPRatio:OFFSet:BWIDth 20 MHz

3.9.8.4 Freq Offset

Set the difference between carrier center frequency and noise center frequency.

Command format	[[:SENSe]:CNRatio:OFFSet [:SENSe]:CNRatio:OFFSet?
Instructions	Sets/gets frequency offset
Parameter Type	Float , Unit: Hz , kHz , MHz , GHz
Parameter Range	100 Hz~700 MHz
Return	Float , Unit: Hz
Example	:ACPRatio:OFFSet 20 MHz

3.9.9 Harmonics

The harmonic power and total harmonic distortion of carrier signal are measured. The maximum measurable harmonic is 10th harmonic. The fundamental wave amplitude of carrier signal must be greater than - 50 dBm, otherwise the measurement result is invalid.

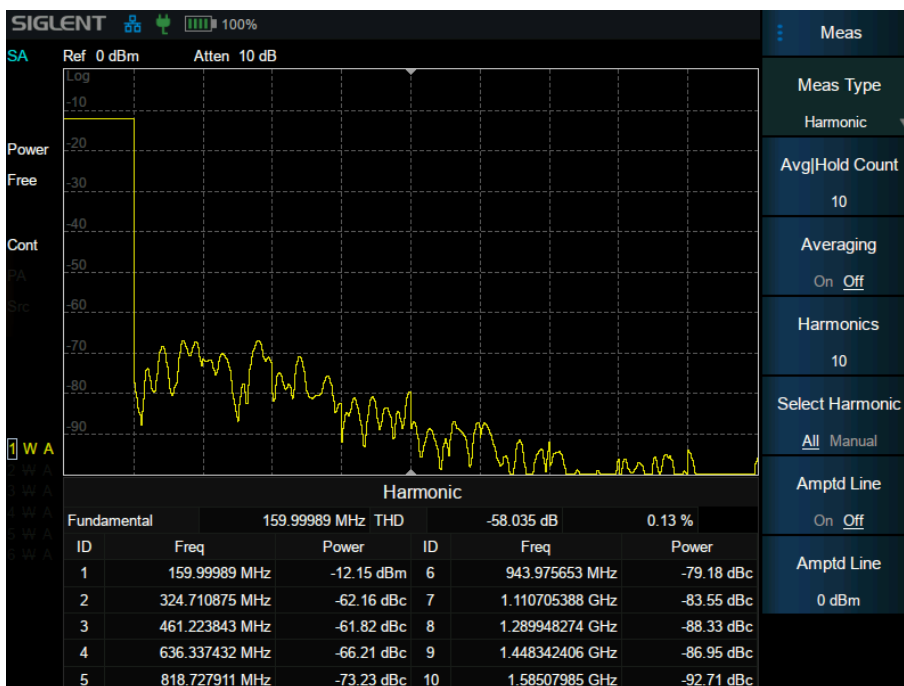

Figure 3-14 Harmonics

3.9.9.1 Measurement Results:

Each harmonic amplitude and total harmonic distortion of carrier signal. It can measure up to 10th harmonic.

3.9.9.2 Fundamental

Set the frequency of the fundamental wave.

If the automatic mode is turned on, the fundamental wave will be automatically found from the first scan. If the automatic mode is turned off, the user can input the fundamental frequency manually.

Command format	<code>[[:SENSE]:HARMonics:FREQUency:FUNDamental [:SENSE]:HARMonics:FREQUency:FUNDamental?</code>
Instructions	Set the fundamental frequency Get the fundamental frequency
Parameter Type	Float , Unit: Hz , kHz , MHz , GHz
Parameter Range	1 Hz~7.5 GHz
Return	Float , unitHz
Example	<code>HARMonics:FREQUency:FUNDamental</code> 20 MHz

Command format	<code>[[:SENSE]:HARMonics:FREQUency:FUNDamental:AUTO [:SENSE]:HARMonics:FREQUency:FUNDamental:AUTO?</code>
Instructions	Set the fundamental frequency Get the fundamental frequency
Parameter type	Boolean
Parameter Range	0 1
Return	0 1
Example	<code>HARMonics:FREQUency:FUNDamental:AUTO</code> 1

3.9.9.3 Freq Step

Set the harmonic step. In auto mode, the frequency of a harmonic is a multiple of the fundamental frequency.

Command format	<code>[[:SENSE]:HARMonics:FREQUency:STEP[:INCRement] [:SENSE]:HARMonics:FREQUency:STEP[:INCRement]?</code>
Instructions	Set the frequency step Get the frequency step
Parameter Type	Float , Unit: Hz , kHz , MHz , GHz
Parameter Range	1 Hz~7.5 GHz
Return	Float , unitHz
Example	<code>:HARMonics:FREQUency:STEP</code> 20 MHz

Command format	<code>[[:SENSE]:HARMonics:FREQUency:STEP[:INCRement]:AUTO [:SENSE]:HARMonics:FREQUency:STEP[:INCRement]:AUTO?</code>
Instructions	Set the frequency step Get the frequency step
Parameter type	Boolean

Parameter Range	0 1
Return	0 1
Example	:HARMonics:FREQuency:STEP:AUTO 1

3.9.9.4 Harmonic Num

Set the total number of the harmonics to be measured.

Command format	[:SENSe]:HARMonics:NUMBer [:SENSe]:HARMonics:NUMBer?
Instructions	Set harmonic number Querying harmonic number
Parameter Type	Integer
Parameter Range	2 ~ 10
Return	Integer
Example	:HARMonics:NUMBer 5

3.9.9.5 Select Harmonic

When "All " is selected, the trace shows the fundamental wave and all harmonics in the sweep bandwidth.

When 1-10 is selected, the trace shows a zero span trace corresponding to the fundamental wave or the measured harmonic.

Command format	[:SENSe]:HARMonics:SELEct [:SENSe]:HARMonics:SELEct?
Instructions	Set select harmonic Query select harmonics
Parameter Type	Integer
Parameter Range	0 ~ 10
Return	Integer
Example	:HARMonics:SELEct 7

3.9.10 IQ Acquisition

IQ acquisition is a zero-sweep measurement similar to scan analysis, displaying the input signal as an I/Q data result, and is commonly used to measure digitally modulated signals.

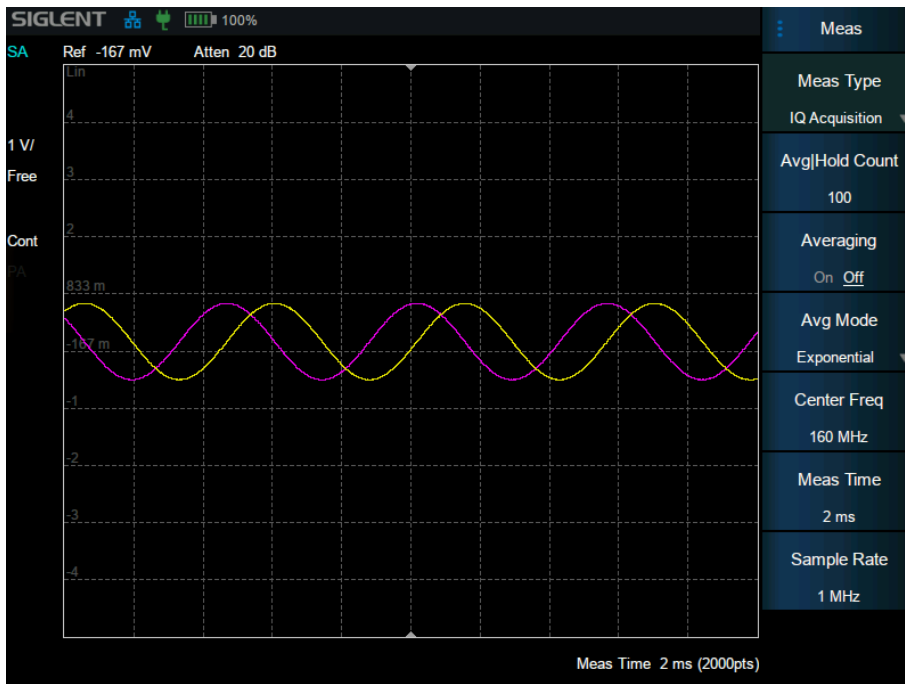

Figure 3-15 IQ Acquisition

3.9.10.1 Average Mode

Select the type of control used for the averaging function. This determines the average operation after the specified number of data acquisitions (average count) has been reached. Options include:

Exponential:

The measure average operation continuously calculates a weighted average for each index using a specified number of averages.

Repeat:

Each time the specified average is reached, the measurement resets the average counter.

Command format	[[:SENSe]:WAVeform:AVERage:TCONtrol [:SENSe]:WAVeform:AVERage:TCONtrol?]
Instructions	Set average mode Get average mode
Parameter Type	enumeration
Parameter Range	EXPONential REPEat
Return	Enumeration :EXPONential REPEat
Example	:WAVeform:AVERage:TCONtrol REPEat

3.9.10.2 Measuring time

Set the time for collecting signals.

Command format	[[:SENSe]:WAVeform:SWEep:TIME [:SENSe]:WAVeform:SWEep:TIME?]
-----------------------	---

Instructions	Set measuring time Set measuring time
Parameter Type	Float,unit ks,s,ms,us
Parameter Range	1us ~ 10s
Return	Float
Example	:WAVeform:SWEp:TIME 100ms

3.9.10.3 Sampling rate

Set the rate of signal collection, that is, the logarithm of IQ collected by 1s.

Command format	[[:SENSe]:WAVeform:SRATe [:SENSe]:WAVeform:SRATe?
Instructions	Set Sampling rate Get Sampling rate
Parameter Type	Float , unit: Hz , kHz , MHz , GHz
Parameter Range	1kHz ~ 20MHz
Return	Float , UNIT Hz
Example	:WAVeform:SRATe 200kHz

3.9.10.4 Sampling period

The inverse of the sampling rate. Only commands can be used for query, but Settings are not supported.

Command format	[[:SENSe] :WAVeform:APERture?
Instructions	Get the Sampling period
Return	Float , unit :s
Example	:WAVeform:APERture?

4 Cable and Antenna Mode

4.1 Meas Settings

CAT mode provides multiple measurements for different measurement scenarios.

4.1.1 Distance to Fault Measurement

DTF (Distance to Fault) measurements are generally used to locate problems, or faults, in a length of cable or transmission line. In order to carry out the correct DTF measurement, the wire/ connector/ jumper is required to connect the cable to the instrument. Besides, the cable length, working frequency range, and the attenuation and velocity factor should be acknowledged in advance.

Measurement steps:

1. Connect any necessary jumper cable or adapter to the SHA802X Port1.
2. Press **Freq / Dist** in the menu to set the frequency range appropriately and set the stop distance of the cable.
3. Press **Cal** and follow the Cal prompts to perform calibration.
4. Connect a LOAD at the end of the DUT if possible and then connect the start end of the DUT to the SHA802X.
5. Press **Meas** to set the **Velocity Factor** and **Cable Att** of the DUT.

Note: A LOAD at the end of the DUT can reduce the repeated reflection inside the DUT.

4.1.1.1 DTF Format

You can select from 3 different DTF formats

Distance to Fault (dB): Faults are displayed on the Y-axis in return loss format. expressed in unit dB.

DTF (VSWR): Faults are displayed on the Y-axis in SWR.

DTF (Lin): Faults are displayed on the Y-axis in linear(unitless)format.

Command Format	:CALCulate[:SELEcted]:DTF:FORMat :CALCulate[:SELEcted]:DTF:FORMat?
Instruction	Set/get the dtf meas format
Parameter Type	enumeration
Parameter Range	LOG , LIN , VSWR
Return	enumeration
Example	:CALCulate:DTF:FORMat LOG

4.1.1.2 Max Meas Distance

In DTF measurements, you set the frequency range of the cable or device to be tested. SHA802X will calculate the max meas distance of the measurement from the frequency settings. If higher distance tested is required, you can set more sweep points or less frequency span. The calculation of the Max distance is as follows:

Max Meas distance = (Sweep Points*Velocity Factor*Speed of Light) / 2* Freq Span

Note: According to the formula, It can be acknowledged that the resolution is only frequency related. That means higher frequency span leads to higher resolution.

4.1.1.3 Velocity Factor

Velocity Factor is a the ratio of the velocity of the electric signal in the cabl to that in the vacuum. For example, A polyethylene dielectric cable has VF =0.66 and a cable with PTFE dielectric has VF =0.7.

In the DTF/TDR measurement it is used to calculate the distances by the reflection time. In order to get accurate positons of the impedance discontinuities, Velocity Factor should be considered and clarified. Distance to Fault Measurement.

Command Format	[:SENSe#]:CORRection:RVELocity:COAX [:SENSe#]:CORRection:RVELocity:COAX?
Instruction	Set/get the velocity factor
Parameter Type	Float
Parameter Range	0.1~1
Return	Float0.1~1
Example	:CORRection:RVELocity:COAX 0.5

4.1.1.4 Cable Loss

Cable Loss is specified in dB/meter. In addition to the length of the cable, loss is also directly proportional to the frequency of the signal that passes through the cable.

For example, The DUT is a 100 meter transmission cable. The Cable Loss value is 0.1Db/meter. That means that a signal traveling one way through the cable will lose 10 dB of power. Considering DTF measurement is performed with 1 port, the signal traveled down the cable and then back, for a total loss of 20 dB.

Command Format	:CORRection:LOSS:COAX :CORRection:LOSS:COAX?
Instruction	Set/get the cable loss
Parameter Type	Float
Parameter Range	-10dB/m~100dB/m
Return	Float
Example	:CORRection:LOSS:COAX 5

4.1.1.5 Window

Due to the limitations of instrument, the measured data is restricted to the frequency range rather than an infinite range. That means the frequency domain data is truncated at the start/end of the data sample, which will cause overshooting and ringing in the time domain.

Therefore, the window should be applied to gradually reduce the marginal frequency response and control the side lobe formed by the truncation.

Press **Meas->Window** to choose from the following:

Rectanglar, Hamming and Off.

Command Format	CALCulate:DTF:TRANSform:WINDow CALCulate:DTF:TRANSform:WINDow?
Instruction	Set/get the dtf window
Parameter Type	enumeration
Parameter Range	OFF , RECT , HAMM
Return	enumeration
Example	CALCulate:DTF:TRANSform:WINDow OFF

4.1.2 Return Loss Measurements

Return loss can be thought of as the absolute value of the reflected power compared to the incident power.

For instance, when measuring an OPEN or SHORT, all incident power is reflected and approximately 0 dB return loss is displayed. When measuring a LOAD, very little power is reflected and values of 40 dB to 60 dB are displayed.

4.1.3 1-Port Cable Loss Measurements

All cables have inherent loss, plus weather and time will deteriorate cables and cause even more energy to be absorbed by the cable. The cable loss will affect the power loss of the transmitter and will have a negative impact on the return loss of the system.

In Distance to Fault measurement, it is not apparent to observe the degree of deteriorating. In such case, Cable Loss measurement is necessary to measure the accumulated losses throughout the length of the cable.

4.1.4 2-Port Insertion Loss Measurement

Insertion loss refers to the loss of load power caused by the cable or components inserted between the transmitter and receiver, usually referred to as attenuation. The insertion loss is expressed in dB corresponding to the received signal level. This measurement is consistent with S21 measurement in VNA mode.

Use **2-Port Insertion Loss** measurement to measure the loss of DUT in a specific frequency range. On SHA802X, Output signal was transmitted from Port1/Source through cable to RF in/Port2. Both ends of the DUT must be connected to the SHA802X.

A 2-port Insertion Loss measurement is usually more accurate than a 1-port Cable Loss measurement.

4.1.5 Time Domain Reflection Measurement

In time domain reflection measurement, the frequency domain data is converted to time domain data by inverse Fourier transform. The response values appear separated in time, allowing a different perspective of the test device's performance and limitations. The Time Domain response not only shows the location of the mismatch point, but also displays the characteristic of the impedance discontinuity. It helps quickly locate the fault point on the cable, and preliminarily identify the fault type. If there are multiple mismatches in the cable, the measurement steps are the same as with DTF.

4.1.5.1 TDR Format

TDR (Lin rho): The Y-axis of the display is linear, real, unitless values. A trace without reflections shows as 0 while maximum reflections from an open or short show as 1.

TDR (ohm): The Y-axis of the display is impedance (ohms).

Command Format	:CALCulate[:SElected]:TDR:FORMat :CALCulate[:SElected]:TDR:FORMat?
Instruction	Set/get the tdr meas format
Parameter Type	enumeration
Parameter Range	OHM , LIN
Return	OHM LIN
Example	:CALCulate:TDR:FORMat LIN

4.1.5.2 Frequency Mode

In time domain reflection measurement, in order to stimulate a traditional TDR measurement, there are some specific limitations on the frequency range of the measurement.

It is required that the measured, positive data points are linearly spaced so that they are harmonically related from DC to the stop frequency. The measurement frequencies must be set so that the stop frequency meets the formula:

$$f_{stop} = f_{start} * Sweep\ points$$

Since the Fourier Transform includes effects of the DC value on the frequency response and the analyzer does not measure the DC response, the DC value is extrapolated and calculated, as it is required to generate the step stimulus. The remainder of the data is calculated from taking a mirror image of the original measured response. The assumption is that the response is Hermitian, in that the negative frequency response is conjugate of the positive frequency response and thus, the time domain response must be pure real-valued.

If the frequency range is limited to band-pass and does not meet the criterion above, then the **Distance to Fault** measurement should be used instead. If the frequency step is large, there will be undersampling occurring. The predominant symptom of this is the measured impedance is incorrect. For example, when measuring a 50 Ω cable, the measurement result of a part/point without reflections is 30 Ω.

To avoid undersampling, try to set stop frequency to a smaller value if the maximum measurement range allows, and ensure that the start frequency is below 500kHz as far as possible to obtain a higher resolution.

4.1.5.3 Velocity Factor

Velocity Factor is the ratio of the velocity of the electric signal in the cable to that in the vacuum. For example, a polyethylene dielectric cable has $VF = 0.66$ and a cable with PTFE dielectric has $VF = 0.7$.

In the DTF/TDR measurement it is used to calculate the distances by the reflection time. In order to get accurate positions of the impedance discontinuities, Velocity Factor should be considered and clarified. Distance to Fault Measurement.

Command Format	<code>[:SENSe#]:CORRection:RVELOCITY:COAX</code> <code>[:SENSe#]:CORRection:RVELOCITY:COAX?</code>
Instruction	Set/get the velocity factor
Parameter Type	Float
Parameter Range	0.1~1
Return	Float 0.1~1
Example	<code>:CORRection:RVELOCITY:COAX 0.5</code>

4.1.5.4 Cable Loss

Cable Loss is specified in dB/meter. In addition to the length of the cable, loss is also directly proportional to the frequency of the signal that passes through the cable.

For example, The DUT is a 100 meter transmission cable. The Cable Loss value is 0.1Db/meter. That means that a signal traveling one way through the cable will lose 10 dB of power. Considering DTF measurement is performed with 1 port, the signal traveled down the cable and then back, for a total loss of 20 dB.

Command Format	<code>:CORRection:LOSS:COAX</code> <code>:CORRection:LOSS:COAX?</code>
Instruction	Set/get the cable loss
Parameter Type	Float
Parameter Range	-10dB/m~100dB/m
Return	Float
Example	<code>:CORRection:LOSS:COAX 5</code>

4.1.5.5 Stimulus Type

You can change the stimulus type to observe different response.

Impulse:

In inverse calculation, the frequency spectrum of an ideal unit impulse response is constant 1. So the inverse Fourier transform of the frequency domain data is the impulse response.

Step:

The Step response is the calculation result obtained by integrating the corresponding trace data of the impulse stimulation response.

Command Format	CALCulate:TDR:STIMulus:TYPE CALCulate:TDR:STIMulus:TYPE?
Instruction	Set/get the stimulation type
Parameter Type	enumeration
Parameter Range	IMPULSe , STEP
Return	enumeration
Example	CALCulate:TRANSform:DISTance: TYPE STEP

4.1.5.6 Kaiser Beta

Like the Windowing in DTF measurement, Kaiser window is used in Time Domain Refelction to reduce overshooting and ringing during the inverse Fourier Transform.

By setting the **Kaiser Beta** in **Meas** window, it changes the rise time and impulse width of the stimulus signal. Essentially it realizes the suppression of truncation effect and the sidelobe level. The larger the Kaiser beta is, the more obvious the suppression effect will be, but at the same time, it will increase the rise time of stimulus signal. thus reducing the resolution of the time domain transformation result.

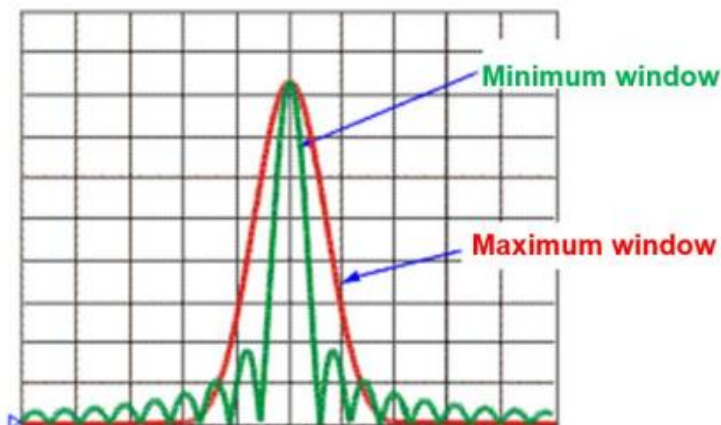

Figure 4-1 Kaiser Beta

Command Format	CALCulate:TDR:WINDow:beta CALCulate:TDR:WINDow:beta?
Instruction	Set/get the beta of the kaiser window
Parameter Type	Float
Parameter Range	0~13
Return	Float
Example	CALCulate:TDR:WINDow:beta 6

4.1.5.7 Time Gating

When viewing the Time Domain reponse of a device, the gating function allows manually choose the required time-domain response and elimilate undesired time domain response, and then view the frequency domain characteristic curve of the required reponse through Fourier transform, The gating function enables the DUT to be characterized without connectors or adapters.

Operating Steps:

Click **Meas** on the panel/menu, then choose **Time Gating** to open the menu, then set the **Gate start**, **Gate Stop**, **Gate Type** and **Gate Shape** in the menu. It is recommended to perform in **TDR & Return Loss** measurement so that the frequency response after gating can be viewed.

Gating on: Open or close the gating function.

Gate Start: Set the start distance of the gate.

Gate Stop: Set the stop distance of the gate.

Gate Type: Set the type of filtering perfomed by the gating function.

Band Pass: Keep the response in the gating span.

Notch: Remove reponse using the gating span.

Gate Shape: Set the filter characteristics of the gating function. There are four options: minimum, normal, wide, and maximum.

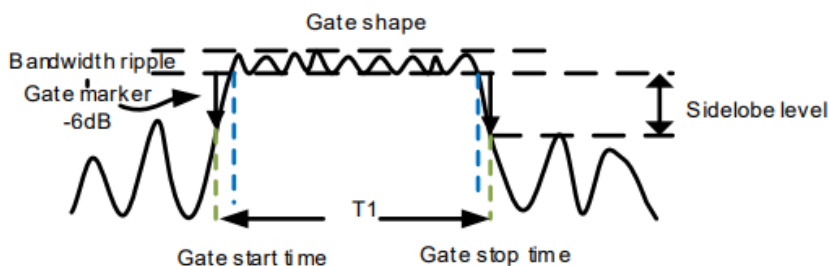

Figure 4-2 Gate Shape

Parameter description of gating function:

Gate shape	Bandwidth ripple	Sidelobe level
Minimum	±0.1 dB	-25dB
Normal	±0.1 dB	-45dB
Wide	±0.1 dB	-52dB
Maximum	±0.01 dB	-80dB

4.1.6 Output Power

Set the output power of **Port 1**. The default power is 0 dbm, which is the maximum power. When measuring long cable or passive high loss device, use high outpower is suggested.

Command Format	:SOURce#:POWer[:LEVel][:IMMediate][:AMPLitude] :SOURce#:POWer[:LEVel][:IMMediate][:AMPLitude]?
Instruction	Set/get the output power
Parameter Type	Float, unitless
Parameter Range	-40dB ~ 0 dB
Return	Float
Example	:SOURce1:POWer -20

4.2 Freq/Dist

Set the frequency or distance range of the current measurement. Distance range can only be set in DTF/TDR.

Set the appropriate RF frequency to observe the correct corresponding trace of the DUT(cable, antenna, etc.).

Start: Specify the starting frequency of the swept measurement range

Stop: Specify the end frequency of the swept measurement range

Start Distance: Specify the start distance of the measurement result to be displayed. The default is 0 m, which means it will display the trouble points from the calibration plane.

Stop Distance: Specify the stop distance of the measurement result to be displayed. It can not be set above max meas distance. The frequency range settings will affect the max meas distance, Refer to 4.9.1.2 **Max Measurement Distance** for details.

The default distance unit is Meter, it can be changed to Feet.

Command Format	[:SENSe]:FREQuency:STARt [:SENSe]:FREQuency:STARt?
Instruction	Set/query the start frequency
Parameter Type	Float , Unit: Hz , kHz , MHz , GHz
Parameter Range	100kHz~7.4999999GHz
Return	Float , Unit: Hz
Example	:FREQuency:STARt 100 Hz

Command Format	[:SENSe]:FREQuency:STOP [:SENSe]:FREQuency:STOP?
Instruction	Set/query the stop frequency
Parameter Type	Float , Unit: Hz , kHz , MHz , GHz
Parameter Range	100.1kHz ~ 7.5GHz
Return	Float , Unit: Hz
Example	:FREQuency:STOP 1.0 GHz

Command Format	CALCulate:TRANsform:DIStance:STARt CALCulate:TRANsform:DIStance:STARt?
Instruction	Set/get the start distance
Parameter Type	Float

Parameter Range	0~max distance-0.2m
Return	Float
Example	CALCulate:TRANSform:DISTance:START 1m

Command Format	CALCulate:TRANSform:DISTance:STOP CALCulate:TRANSform:DISTance:STOP?
Instruction	Set/get the stop distance
Parameter Type	Float
Parameter Range	0~max distance
Return	Float
Example	CALCulate:TRANSform:DISTance:STOP 2

Command Format	CALCulate:TRANSform:DISTance:UNIT CALCulate:TRANSform:DISTance:UNIT?
Instruction	Set/get the distance unit
Parameter Type	Enumeration
Parameter Range	METers FEET
Return	MET FEET
Example	CALCulate:TRANSform:DISTance:UNIT FEET

4.3 Amplitude

4.3.1 Scale/Reference level and Position

Scale : Sets the vertical indexing value of the coordinate. The setting range is different under each measurement.

Command Format	:DISPlay:WINDow#:TRACe1 2 :Y[:SCALe]:PDIVision :DISPlay:WINDow#:TRACe1 2 :Y[:SCALe]:PDIVision?
Instruction	Set/query the scale
Parameter Type	Float
Parameter Range	1~999
Return	Float
Example	:DISPlay:WINDow1:TRACe1:Y:PDIVision 10

Reference level : Sets the value of the guide.

Command Format	:DISPlay:WINDow#:TRACe1 2 :Y[:SCALe]:RLEVel :DISPlay:WINDow#:TRACe1 2 :Y[:SCALe]:RLEVel?
Instruction	Set/query the ref level
Parameter Type	Float
Parameter Range	1~999
Return	Float
Example	:DISPlay:WINDow1:TRACe1:Y: RLEVel 10

Reference Position : Sets the position of the guide of rectangular coordinate. Zero is the bottom line and 10 is the top line. The default position is 5, which is middle of screen.

Command Format	:DISPlay:WINDow#:TRACe#:Y[:SCALe]:RPOSition :DISPlay:WINDow#:TRACe#:Y[:SCALe]:RPOSition?
Instruction	Set/query the ref pos
Parameter Type	Integral
Parameter Range	0~10
Return	Integral
Example	:DISPlay:WINDow1:TRACe1:Y: RPOSition 5

4.3.2 Automatic Scaling

Auto Scale : Automatically sets the vertical indexing value and reference value to fit the working data trace in the screen grid area. The excitation value and reference position are not affected. SHA802X will determine the minimum possible scaling factor that will allow all display data to appear on the 80% vertical grid.

Command Format	:DISPlay:WINDow#:TRACe#:Y[:SCALe]:AUTO
Instruction	Set the auto scale
Example	:DISPlay:WINDow#:TRACe#:Y[:SCALe]:AUTO

Auto Scale All : automatically scales all data traces in the working window to fit vertically into the grid area of the screen.

4.4 Sweep

4.4.1 Points

Sweep Points are the number of data samples representing the measured values in a single sweep. More sweep points will improve the resolution of the waveform, but also affect the minimum sweep time, increase the data processing time and remote access time, and reduce the response rate.

4.4.2 Sweep Time

Sweep time is automatically set according to the Sweep points by default. When Sweep time mode is auto, the fastest response time that analyzer need to configure the hardware and collect every single point data is calculated and applied.

When measuring long lengths of cable, you can slow the sweep time so that more stable and reliable waveform can be observed.

Note: Setting the sweep time manually will change the sweep time mode.

Command Format	[:SENSe]:SWEep:TIME [:SENSe]:SWEep:TIME?
Instruction	Set/query the sweep time
Parameter Type	Float , Unit : ks, s, ms, us
Parameter Range	1us ~ 6000s
Return	Float , Unit:s
Example	:SWEep:TIME 5s

Command Format	[:SENSe]:SWEep:TIME:AUTO OFF ON 0 1 [:SENSe]:SWEep:TIME:AUTO?
Instruction	Set/query the sweep time auto state
Parameter Type	Boolean
Parameter Range	OFF ON 0 1
Return	0 1
Example	:SWEep:TIME:AUTO 1

4.4.3 Sweep/Measure

Sweep/Measure :

Single/Continue , controls analyzer to perform single or continuous sweep/measure.This setting is Continue by default.

Restart :

Restart the current sweep or measure.In particular, if the sweep parameters are modified, a restart will be performed.Sweep parameters include frequency, sweep , average settings.

Command Format	:INITiate:CONTInuous OFF ON 0 1 :INITiate:CONTInuous?
Instruction	Set/query the continuous sweep mode
Parameter Type	Boolean
Parameter Range	OFF ON 0 1
Return	0 1
Example	:INITiate:CONTInuous OFF

Command Format	:INITiate[:IMMediate]
Instruction	Restart sweep
Example	:INITiate:IMMediate

4.5 Averaging

Use averaging to help smooth a trace and reduce the effects of random noise on a measurement. It will average the multiple sweep results of every point according to the average times setting. The higher the number of average times, the more random noise is eliminated.

Click **BW**→**Averaging/Avg Times** to enable averaging and set average times.

When the Averaging is enabled, the number of sweeps currently used for averaging and the average times are displayed on the left statusbar.

Command Format	[:SENSe#]:AVERAge[:STATe] [:SENSe#]:AVERAge[:STATe]?
Instruction	Set/query the average state
Parameter Type	Boolean
Parameter Range	OFF ON 0 1
Return	0 1
Example	:Average 1

Command Format	[:SENSe#]:AVERAge:COUNT [:SENSe#]:AVERAge:COUNT?
Instruction	Set/query the average number
Parameter Type	Integral
Parameter Range	1~999
Return	Integral
Example	:Average:COUNT 25

4.6 Trace

4.6.1 Select Trace

For the coupling measurement in CAT, such as DTF&Return Loss, there are two traces to be selected. Use **Select Trace** for trace setting, calculation and other operations. For those single measurement like VSWR, it has only one trace and it is not selectable.

Command Format	:CALCulate#:PARAmeter:SELEct
Instruction	Set the select trace
Parameter Type	Integral
Parameter Range	1~2
Example	:CALCulate:PARAmeter:SELEct 1

4.6.2 Display Trace

The analyzer supports saving the current data-trace in memory. It can perform four kinds of mathematical operations on the current data-trace and memory trace. When the mathematical operation with memory trace needs to be carried out, the current data needs to be stored in memory first.

Go to **Trace** menu, Click **Data**→**Memory** to complete the storage operation.

Command Format	:CALCulate#[[:SElected]:MATH:MEMorize
Instruction	Memorize the data from current trace
Example	:CALCulate:MATH:MEMorize

If memory trace data was valid, In the Display menu bar, you can select four display modes: Display data-trace only, display memory trace , display data-trace and memory trace at the same time and display off.

Command Format	:DISPlay:WINDow#:TRACe1 2 3 4:STATe :DISPlay:WINDow#:TRACe1 2 3 4:STATe?
Instruction	Sets/gets data-trace to open or off
Parameter Type	Boolean
Parameter Range	OFF ON 0 1
Return	0 1
Example	:DISPlay:WINDow:TRACe2:STATe 1

Command Format	:DISPlay:WINDow#:TRACe1 2 3 4:MEMory[:STATe] :DISPlay:WINDow#:TRACe1 2 3 4:MEMory[:STATe]?
Instruction	Sets/gets mem-trace to open or off
Parameter Type	Boolean
Parameter Range	OFF ON 0 1
Return	0 1
Example	:DISPlay:WINDow:TRACe2:MEMory 1

4.6.3 Math

The four mathematical operations of data-trace and memory trace are as follows, in which the values on data-trace and memory trace are linear:

Data/Memory : Divide the measured data by the data in the stored trace. This function can be used to calculate the ratio of two traces (such as calculating gain or attenuation), which can also be regarded as the normalization operation of test data.

Data*Memory : The current measurement data is multiplied by the data in memory.

Data+Memory : Current measurement data plus data in memory.

Data-Memory : Current measurement data minus data in memory. For example, you can use this function to store measured data. The error is then subtracted from the DUT measurement.

Command Format	:CALCulate#[:SElected]:MATH:FUNction OFF DIVide MULtiplY SUBtract ADD :CALCulate#[:SElected]:MATH:FUNction?
Instruction	Sets/gets mathematical operations on current trace
Parameter Type	Enumeration
Parameter Range	OFF DIVide MultiplY SUBtract ADD
Return	Enumeraiton, OFF DIVide MULtiplY SUBtract ADD
Example	:CALculate:MATH:FUNC DIVide

Note: In DTF and TDR measurement, Math is not supported.

4.7 Marker & Peak

4.7.1 Marker Settings

The marker appears as a rhombic sign for identifying points on a trace and display defined measurement data of traces. The analyzer allows for up to seven markers and one reference marker to be displayed on one trace.

4.7.1.1 Select Marker

Press the **Marker** button on the front panel and go to Marker menu. If there is no active marker, Marker1 will be automatically turned on. After the marker is created, the measurement value of the marker will be displayed at the top right of the window, and the value format is the same as the format of the trace. Click **Select Marker** to select desired marker. When a marker is selected, you can set its type, trace to be marked, X values and other related parameters.

Command Format	:CALCulate:MARKer:SELEct :CALCulate:MARKer:SELEct?
Instruction	Set/query the current marker
Parameter Type	enumeration 1-8
Return	enumeration : 1-8
Example	:CALCulate:MARKer:SELEct 5

Command Format	:CALCulate:MARKer[1] 2 3 4 5 6 7 8:TRACe 1 2 :CALCulate:MARKer[1] 2 3 4 5 6 7 8:TRACe?
Instruction	Set/query the marker mark trace
Parameter Type	enumeration
Parameter Range	1 2
Return	enumeration
Example	CALCulate:MARK:TRAC 1

4.7.1.2 Marker Type

Three types of marker are supported as follow:

Normal:

It is used to measure the X (Frequency or Time) and Y (Amplitude) values of a certain point on the trace. When selected, a marker with the number of the current marker (such as “1”) appears on the trace. If there is no active marker exists currently, a marker will be enabled automatically at the center frequency of the current trace. If selected marker has been opened and configured before, reopen the marker will set to the previous X values.

Note: The readout resolution of the X-axis (frequency or time) is related to the span. For higher readout resolution, reduce the span.

Delta:

It is used to measure the delta values of X (Frequency or Time) and Y (Amplitude) between the reference point and a certain point on the trace. When selected, a pair of markers appear on the trace. Fixed Reference marker (marked by letter “R”) and the Delta Marker (marked by the “Δ”, such as “Δ1”)

Note: After the marker selects “Delta”, the original marker will become the delta measurement marker, and the reference marker will automatically turn on. The readout information on current Delta marker will show the frequency (or time) difference and amplitude difference compared to the Reference Marker’s value.

Off:

Turn off the marker currently selected. The marker information displayed on the screen and functions based on the marker will also be turned off.

Command Format	:CALCulate:MARKer[1] 2 3 4 5 6 7 8:MODE :CALCulate:MARKer[1] 2 3 4 5 6 7 8:MODE?
Instruction	Sets/gets marker type
Parameter Type	Enumeration
Parameter Range	POSition DELTA OFF
Return	POS DELTA OFF
Example	:CALCulate:MARK1:MODE POSition

Command Format	:CALCulate:MARKer[1] 2 3 4 5 6 7 8:STATe :CALCulate:MARKer[1] 2 3 4 5 6 7 8:STATe?
Instruction	Sets/gets marker on/off state
Parameter Type	Boolean
Parameter Range	OFF ON 0 1
Return	0 1
Example	:CALCulate:MARK1:STATe ON

Note: Marker 8 equals reference marker, which can not be set to Delta Marker type.

Command Format	:CALCulate:MARKer:AOFF
Instruction	Sets all marker type to Off
Example	:CALCulate:MARKer:AOFF

4.7.1.3 Marker X

Displays and sets the x-axis position of the marker. The unit of readout values is identical to the current x-axis. For instance, When the measurement is Distance to Fault, the unit is meter, and when the measurement is Return Loss, the unit is frequency.

When setting marker X value, it can only be set within the range of the current X axis. When the measurement range/span changes, the exceeding Marker will be set to the current measurement start value or stop value, depending on whether the Marker X value exceeds the start value or stop value.

When the marker type is **Off** , the marker X is not settable

Command Format	:CALCulate:MARKer[1] 2 3 4 5 6 7 8:X :CALCulate:MARKer[1] 2 3 4 5 6 7 8:X?
Instruction	Sets/gets the marker X value This command is effective only when the marker mode is not Off Use command below to set marker mode/type: :CALCulate:MARKer[1] 2 3 4 5 6 7 8:STATe :CALCulate:MARKer[1] 2 3 4 5 6 7 8:MODE
Parameter Type	Frequency, Float, Unit Hz, kHz, MHz, GHz, default to Hz Time, Float, Unit us, ms, s, ks, default to s
Parameter Range	100kHz to max frequency or 10ms ~ 1000s
Return	Frequency, Float, Unit Hz; Time, Float, Unit s;
Example	:CALCulate:MARKer4:X 0.4 GHz :CALCulate:MARKer4:X 200 ms :CALCulate:MARKer4:X?

Command Format	:CALCulate:MARKer[1] 2 3 4 5 6 7 8:Y?
Instruction	gets marker Y value When the data format is Smith/Polar, there are multiple returned values depending on the specific Smith/Polar Type.
Return	LoMag, Float, unit dB; Phase, Float, unit degree; SWR, Float, unitless(U); Group Delay, Float, time(s); LinMag, Float, unitless(U)
Example	:CALCulate:MARKer1:Y? Return : -25
Command Format	:CALCulate:MARKer[1] 2 3 4 5 6 7 8:Y?

4.7.1.4 Markers All Off

Use **Markers All Off** to set all markers' type to Off.

Command Format	:CALCulate:MARKer:AOFF
Instruction	Close all markers
Example	:CALCulate:MARKer:AOFF
Parameter Type	Float
Return	Float , Unit: Consistent with the current measurement Y-axis format
Example	:CALCulate:MARKer1:Y? Return : -25

4.7.1.5 Marker Couple

This is a specific setting for DTF&TDR measurement in CAT as only under such measurement can there be multiple traces with the same X-Axis (distance).

When Marker Couple is on, Markers are set up and moved in coupled operation on all traces.

When Marker Couple is off, Markers are set up and moved independently for each trace.

Command Format	:CALCulate[:SElected]:MARKer:COUPle :CALCulate[:SElected]:MARKer:COUPle?
Instruction	Sets/gets the marker couple state
Parameter Type	Boolean
Parameter Range	ON OFF 0 1
Return	0 1
Example	:CALCulate:MARKer:COUPle 1 :CALCulate:MARKer:COUPle?

4.7.2 Peak Search

Open the peak setting menu and execute peak search. Press **Peak** to search for positive value which is greater than the measured value at both ends of a span. Press **Valley** to perform the oppsite search.

Command Format	:CALCulate:MARKer[1] 2 3 4 5 6 7 8:MAXimum
Instruction	Marker searches for peaks on the selected trace and marks them with the current selected marker
Example	:CALCulate:MARKer4:MAXimum

Command Format	:CALCulate:MARKer[1] 2 3 4 5 6 7 8:Minimum
Instruction	Marker searches for valleys on the selected trace and marks them with the current selected marker
Example	:CALCulate:MARKer4:Minimum

4.7.3 Continue Peak/Valley

Enable or disable continuous peak search. The default is Off. When enabled, the system will always execute a peak search automatically after each sweep in order to track the signal under measurement.

Note: Each trace only supports one pair of marker to perform continuous peak/valley. For example, if certain marker is doing Continuous Peak, set other marker **Continous Peak** to on will automatically set the previous one to **Off**.

Command Format	:CALCulate:MARKer[1][2][3][4][5][6][7][8]:CPSearch[:STATe] :CALCulate:MARKer[1][2][3][4][5][6][7][8]:CPSearch[:STATe]?
Instruction	Sets/gets Marker Continue Peak Search On/Off state
Parameter Type	Boolean
Parameter Range	ON OFF 0 1
Return	0 !
Example	:CALCulate:MARKer1:CPSEarch ON

Command Format	:CALCulate:MARKer[1][2][3][4][5][6][7][8]:CVSearch[:STATe] :CALCulate:MARKer[1][2][3][4][5][6][7][8]:CVSearch[:STATe]?
Instruction	Sets/gets Marker Continue Valley Search On/Off state
Parameter Type	Boolean
Parameter Range	ON OFF 0 1
Return	0 !
Example	:CALCulate:MARKer1:CVSEarch ON

4.8 Limit

Limit Line is a test form that can visualize test data and results. The limit test compares the measured data with the defined limit and provides the qualified or unqualified judgment information of each measured data point. Limit line and limit test are only available in LogMag/ LinMag data format. When the trace that has limit working on switching to other data format, the limit will automatically set to disable.

Command Format	:CALCulate:LLINe[1][2]:STATe OFF ON 0 1 :CALCulate:LLINe[1][2]:STATe?
Instruction	Sets/gets limit test on/off state
Parameter Type	Boolean
Parameter Range	ON OFF 0 1
Return	0 !
Example	:CALCulate:LLINe1:STATe OFF

4.8.1 Limit Edit

Click **Limit** to the limit menu, Enable certain Limit so that **Limit Edit** submenu is valid. In **Limit Edit**, you can set limit type, limit mode and modify/load/save the limit data.

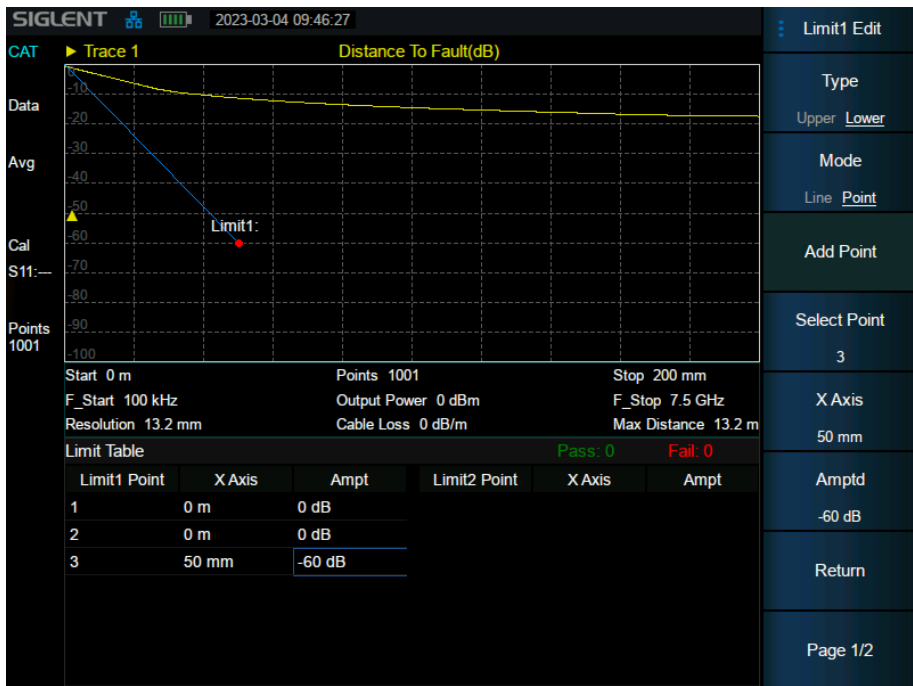

Figure 4-3 Limit Edit

Limit Type:

Set the limit type as upper/lower. This setting is default to **Upper**.

Command Format	:CALCulate:LLINE[1][2]:TYPE :CALCulate:LLINE[1][2]:TYPE?
Instruction	Sets/gets limit type
Parameter Type	Enumeration
Parameter Range	UPPer LOWer
Return	UPP LOW
Example	:CALCulate:LLINE1: UPPer

Limit Mode:

Set Whether the limit line is a straight flat line or a polyline connected by limit points. This setting is default to **Line**.

When the limit mode is **Line**, only setting the limit line amplitude is required. When the limit mode is **Point**, Use add/delete point button in the menu, and set both X and Y value of each point by selecting the specific limit point or directly touch the screen in the limit table to select and set points. After changing the X value of a limit point, the limit points list will be sorted from small to large by X value.

Use the following command to set limit mode:

Command Format	:CALCulate:LLINE[1][2]:MODE :CALCulate:LLINE[1][2]:MODE?
Instruction	Sets/gets limit mode
Parameter Type	Enumeration

Parameter Range	LINE POINT
Return	LINE POINT
Example	:CALCulate:LLINe1: UPPer

Use the following command to set limit line amplitude:

Command Format	:CALCulate::LLINE[1]2:LINE :CALCulate::LLINE[1]2:LINE?
Instruction	Sets/gets limit line amplitude value
Parameter Type	Float
Parameter Range	-150 ddB to 150
Return	Float
Example	:CALCulate:LLINe1:LINE 50

Use the following command to add/set limit point data,

Command Format	:CALCulate:LLINe[1]2:POINT#:DATA val1,val2 :CALCulate:LLINe[1]2:POINT#:DATA? :CALCulate:LLINe[1]2:POINT:ADD val1,val2
Instruction	Sets/gets a specific point data,if point index is greater than the list size, the command will not take effect. Add a point after the current points list
Parameter Type	val1:Float,frequency val2:Float,amplitude
Parameter Range	val1:related with Span val2:-150 to 150
Return	val1:Float,frequency val2:Float,amplitude
Example	:CALCulate:LLINe2:POINT:ADD 100,-20,200,-25 That means add two points: (100,-20) , (200, -25) :CALCulate:LLINe2:POINT4: 100,-20 That means change point4 to (100,-20)

Use the following command to set all limit points

Command Format	:CALCulate:LLINe[1]2:POINTs :CALCulate:LLINe[1]2:POINTs?
Instruction	Sets/gets all limie points This command will erase the previous limit points and set with input values
Parameter Type	val1:Float,frequency val2:Float,amplitude
Parameter Range	val1:related with Span val2:-150 to 150
Return	val1:Float, frequency val2:Float, amplitude
Example	:CALCulate:LLINe2:POINTs 100, -20, 200, -25, 300, -30

Use the following command to delete limit point/points:

Command Format	:CALCulate:LLINe#:POINT#:DELeTe :CALCulate:LLINe#:POINTs:DELeTe
Instruction	Delete certain limit's certain/all limit points
Example	:CALCulate:LLINe1:POINT1:DELeTe :CALCulate:LLINe1:POINTs:DELeTe

4.8.2 Limit Test

Limit Test: According to the Enabled limit, start/stop test on the selected trace.

- If limit Test is set **On** , a pass/fail sign will appear on top of grid area which indicates whether the current trace passed the limit test. When there are two limits taking effect on different trace, the limit result will be result1 & result2.
- If you add two limit points and the X values are the same but Y values are not, the smaller Y value will be tested when the limit type is **Upper** and otherwise the opposite.

Command Format	:CALCulate:LLINe:TEST :CALCulate:LLINe:TEST?
Instruction	Sets/gets the on/off state of limit test switch
Parameter Type	Boolean
Parameter Range	OFF ON 0 1
Return	0 1
Example	:CALCulate"LLINe:TEST 1

Command Format	:CALCulate:LLINe[1]]2]:FAIL?
Instruction	Query the current result of certain limit
Return	0 1
Example	:CALCulate:LLINe2:FAIL1

4.8.2.1 Buzzer

Open/close buzzer function. When the Buzzer is set to **On** and the test result is fail, buzzer will make a short beep.

Command Format	:CALCulate:LLINe:CONTrol:BEEP :CALCulate:LLINe:CONTrol:BEEP?
Instruction	Sets/gets the Buzzer on/off state
Parameter Type	Boolean
Parameter Range	OFF ON 0 1
Return	0 1
Example	:CALCulate:LLINe:CONTrol:BEEP OFF

Attention: If the Buzzer is set to **off** in system settings, despite turning on the buzzer in limit test , it will not beep when test fails.

4.8.2.2 Fail to Stop

This Function meets the demand to observe the failure result. When the fail to stop is set to on and the test fails, it will stop the sweep.

Command Format	:CALCulate:LLINe:FAIL:STOP :CALCulate:LLINe:FAIL:STOP?
Instruction	Sets/gets the fail to stop state
Parameter Type	Boolean
Parameter Range	OFF ON 0 1
Return	0 1
Example	:CALCulate:LLINe:FAIL:STOP OFF

4.9 Calibration

Due to the systematic errors, cabling, adapters, probes and more, the DUT usually can't be measured directly and accurately. These errors are caused by leakage signals inside the instrument, by the frequency response of the receivers, and by reflections inside the instrument that interact with the DUT. It is necessary to introduce calibration compensation to help achieve higher accuracy. After calibration, the S parameter calibration is applied to the calculation results and the errors are removed from subsequent measurements.

4.9.1 Definitions

DUT (Devie Under Test) The Cable, antenna, transmission line, amplifier, filter, or anything else that is connected to the SHA802X that is to be measured.

Calibration Standards – **OPEN, SHORT, LOAD, and THRU**

OPEN, SHORT, and LOAD are 'reflection' standards that are used during calibration. When an RF signal 'hits' these components, the signals are reflected in a predictable manner. These components can also be used to terminate a DUT port during some measurements.

SHORT and **OPEN** standards both cause 100% of an RF signal to be reflected. The difference between these two standards is what happens to the phase of the reflected signal. Although an **OPEN** standard is a precision component, simply leaving **nothing** connected at the end of a cable can be a reasonable substitute for an **OPEN**.

A **LOAD** standard absorbs almost ALL of the incident signal and very little signal is reflected back to the source.

A **THRU** standard is used during some calibration steps to connect PORT1 to PORT2 in place of the DUT. A Flush THRU connection can be made when the cables that connect with the DUT can mate with each other. Otherwise, any reasonably short cable can be used as a THRU standard.

Calbration Reference Plane is the point(or points) at which the DUT and cal standards are connected during a calibration. This can be at the FiedFox test port connectors, or at the end of jumper cables or adapters.

4.9.2 Calibration Kit

4.9.2.1 Standard Cal Kit

SHA802X provides a variety of default calibration kit standards, including **F503, F603, F504, F604, 85032F, 85032B/E, 85032D/E**.

Select correct Cal Kit gender so that correct Cal Kit data is applied in calibration. Please refer to the data manual of coaxial calibration kit for detailed Cal Kit parameters and applicable scenarios.

The Document URL is as follow :

https://siglentna.com/wp-content/uploads/dlm_uploads/2021/04/Mechanical-Calibration-Kit-Datasheet-v1.4.pdf

Command Format	:CORRection:COLLect:CKIT:LABel :CORRection:COLLect:CKIT:LABel?
Instruction	Sets/gets the current cal kit
Parameter Type	enumeration
Parameter Range	\ "F503E\ " , \ "F603E\ " , \ "F504S\ " , \ "F604S\ " , \ "85032F\ " , \ "85032B/E\ " , \ "85033D/E\ " \ "User1\ " , \ "User2\ "
Return	enumeration
Example	:CORRection:COLLect:CKIT:LABel \ "85032F\ "

Command Format	:CORRection:COLLect:CKIT:GENDer :CORRection:COLLect:CKIT:GENDer?
Instruction	Sets/gets the male/female properties of the current calibration suite
Parameter Type	enumeration
Parameter Range	MALE FEMAlE
Return	enumeration
Example	:CORRection:COLLect:CKIT:GENDer MALE

4.9.2.2 User Kit

When the user are using standards (or combinations of standards) that are different from the predefined standard Cal Kits,for example, using three offset SHORTS instead of an OPEN, SHORT, and Load to perform a 1-port calibration, it requires users to create custom User calibration kits.

Operation Instructions:

Press **Cal -> Cal Kit -> User1/User2**, edit types, delays and OPEN/SHORT standard samples to create cusrom kit.

4.9.3 Calibration Type

4.9.3.1 Open Response Calibration

when a single port is used for open-circuit response calibration, the reflection tracking error in the error model of the test device can be calculated by only connecting the OPEN calibration element or even simply NOTHING to the test port. If the Load calibration element is used for isolation calibration at the same time, the directional error can be calculated.

Calibration Steps :

1. **Preset** the instrument.
2. Set internal source output power, sweep points, test frequency band , Cal Kit and other parameters.
3. Select **Cal -> Calibrate -> Open Cal**
4. Connect the OPEN calibration element to the test port according to the interface prompts, click **Open** for calibration, and click **Finish** to exit the calibration interface after calibration, complete the calibration, and save the calibration data.

4.9.3.2 Short Circuit Response Calibration :

Like the open-circuit response calibration, the single-port short-circuit response is connected to the port with the SHORT calibration element, and the reflection tracking error can be calculated. If the Load calibration element is used for isolation calibration at the same time, the directional error can be calculated.

Calibration Steps :

1. **Preset** the instrument.
2. Set internal source output power, sweep points, test frequency band, Cal Kit and other parameters.
3. Select **Cal -> Calibrate -> Short Cal**
4. Connect the SHORT calibration element to the Port 1 according to the interface prompts, click **Short** for calibration, and click **Finish** to exit the calibration interface after calibration, complete the calibration, and save the calibration data.

4.9.3.3 Full 1-Port OSL calibration :

All 1-port OSL calibration connects the OPEN, SHORT, and LOAD calibration elements to the test ports in turn to calculate the reflection tracking error, directional error, and source matching error in the error model of the test device.

Calibration Steps :

1. **Preset** the instrument.

2. Set internal source output power, sweep points, test frequency band , Cal Kit and other parameters.
3. Select **Cal -> Calibrate -> 1-Port Cal**
4. Connect the OPEN calibration element to the Port 1 according to the interface prompts and click **Open** for calibration. Wait till the sweep is complete then connect the SHORT calibration element to the Port 1, click **Short** for calibration. Wait till the sweep is complete then connect the LOAD calibration element to the Port 1, click the **Load** for calibration. After the calibration, click FINISH to exit the calibration inter face , complete the calibration, and save the calibration data.

4.9.3.4 Transimission Response Calibration :

Two-port transmission response calibration is to connect the THRU calibration kit between Port1 and Port2 to calculate the transmission tracking error in the test device error model.

Calibration Steps :

1. **Preset** the instrument.
2. Set internal source output power, sweep points, test frequency band , Cal Kit and other parameters.
3. Select **Cal -> Calibrate -> Response-Thru Cal**
4. Connect the THRU calibration element between Port1 and Port2, click **Thru** for calibration, and click **Finish** to exit the calibration interface, complete the calibration, and save the calibration data.

4.9.3.5 Enhanced Response Calibration:

Two-port enhanced response calibration connects the Thru calibration element between two ports, and connects the Open, Short, and Load on one port for calibration.

Calibration Steps :

1. **Preset** the instrument.
2. Set internal source output power, sweep points, test frequency band , Cal Kit and other parameters.
3. Select **Cal -> Calibrate -> Enhanced-Res Cal**
4. Connect OPEN, SHORT, and LOAD on the Port 1 and press corresponding button to complete the calibration successively, and then connect the THRU calibration kit between the two ports to perform the **Thru** calibration. After the calibration is completed, click **Finish** to exit the calibration interface, complete the calibration and save the calibration data.

After the calibration is complete and data is successfully saved, Corresponding compensation apply

button **Apply xxx Cali** will appear in the menu. Set on/off to control whether applies the calibration data or not.

Here's commands for calibration :

Command Format	:CORRection:COLLect:MEtHod:TYPE :CORRection:COLLect:MEtHod:TYPE?
Instruction	Sets/gets the cal type
Parameter Type	enumeration
Parameter Range	NONE OPEN SHORT 1PORT THRU ENHAnced E11 E21
Return	enumeration
Example	:CORRection:COLLect:MEtHod:TYPE SHORT

Command Format	:CORRection:COLLect:OPEN
Instruction	Collecting open step data
Example	:CORRection:COLLect:OPEN 1

Command Format	:CORRection:COLLect:SHORt
Instruction	Collecting short step data
Example	:CORRection:COLLect:SHORt 1

Command Format	:CORRection:COLLect:LOAD
Instruction	Collecting load step data
Example	:CORRection:COLLect:LOAD 1

Command Format	:CORRection:COLLect:THRU
Instruction	Collecting through step data
Example	:CORRection:COLLect:THRU 1

Command Format	:CORRection:COLLect:SAVE
Instruction	After the calibration procedure is completed, the calibration data is saved and applied
Example	:CORRection:COLLect:SAVE 1

Notice: Highest measurement accuracy is achieved when the frequency range or sweep settings remain the same during the measurement as when the calibration is performed. If these settings change after the calibration, SHA802X will interpolate the calibration so that it can still make VERY accurate measurement.

Interpolated Calibrations are only slightly less accurate than a calibration performed at the measurement settings. When a calibration that you performed is being interpolated, a questionmark will be added to the Cal annotation. For example: S11:C? is shown on the screen when the current Response or Mechanical cal is being interpolated. In order to achive better measurement accuracy, it is recommended to recalibrate after changing the sweep-relevant settings.

4.9.4 Ecal

Ecal is a new automatic calibration technology for VNA mode. Every ECal module contains electronic standards that are automatically switched into position during a measurement calibration. These electronic standards have been measured at the factory and the data stored within the memory of the ECal module. The analyzer uses this stored data, along with the measured data, to calculate the error terms for a measurement calibration. Ecal offers the following advantages compared to Mechanical calibration kit:

1. The calibration process is simple. The electronic calibrator only needs to be connected to the SHA802X once to complete the test items required by the dual-port calibration, without the need for multiple calibration connections.
2. A shorter time is required for calibration.
3. There are fewer uncertain factors in the calibration process, and the probability of electronic calibration being affected by misoperation is reduced because there is no need for multiple connection processes.

Ecal Calibration Steps:

1. Connect the USB port on the ECal module with the USB port of SHA802X via a USB cable. When the Ecal module indicator switch to “Ready”, it indicates the Ecal module has entered ideal working condition/temperature. After connect the module, the type of module, frequency range, and connector type are automatically recognized.
2. Press **Cal->Ecal Info** to view all parameters of the characterization stored in the ECal module.

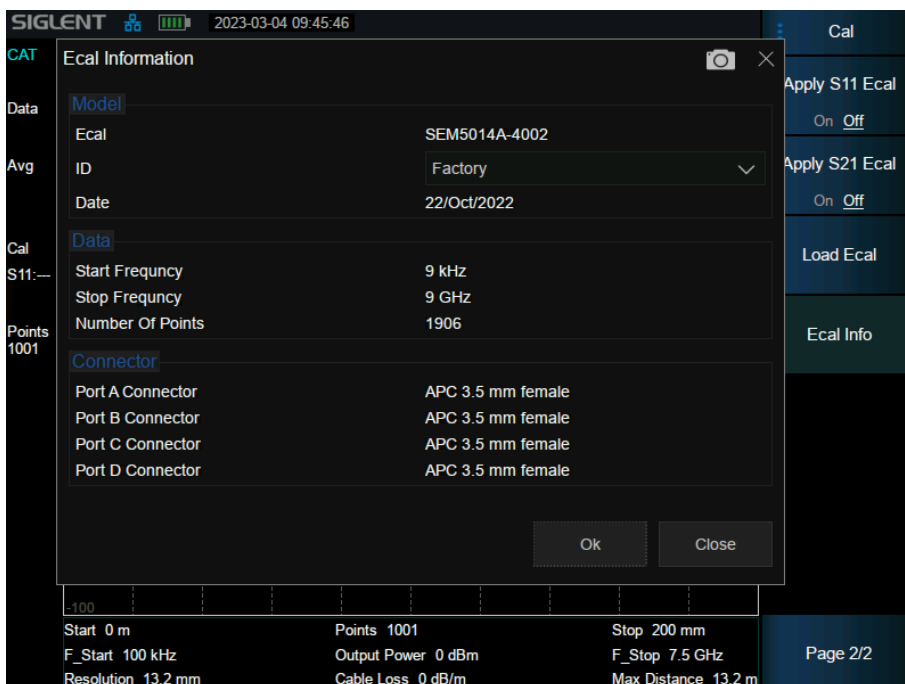

Figure 4-4 Ecal Information

In the figure above, you can see the date of production, frequency range , Number of Points and Connector type.

3. Click **Load Ecal** to start loading the data of selected Measurement characteristics to the SHA802X. If it is loaded before, then it will compare with saved data for consistency.
4. Click **Calibrate ▼**, Select **S11 ECal** or **S21 Ecal** to perform 1 port or two ports calibration respectively. Connect the calibration part and instrument port correctly according to the calibration prompt, click **Enter** to automatically calibrate then click **Finish** to save and apply the calibration data.

Command Format	:CORRection:COLLect:METhod:ECAL?
Instruction	Check whether the electronic calibration part is connected to the instrument
Return	Boolean , 0 1
Example	:CORR:COLL:METh:ECAL?

Command Format	:CORRection:COLLect:ECAL:MODULE :CORRection:COLLect:ECAL:MODULE?
Instruction	Set/query electronic calibration parts available electronic standard sample data
Parameter Type	enumeration
Parameter Range	Determined by electronic calibration part Return example:Factory User1
Return	enumeration
Example	:CORRection:COLLect:ECal:MODULE Factory

Command Format	:CORRection:COLLect:ECAL:LOAD :CORRection:COLLect:ECAL:CANCEL
Instruction	Execute/cancel the electronic calibration part to load the current selected electronic standard sample data
Example	:CORRection:COLLect:ECAL:LOAD

5 Vector Network Analyzer Mode

5.1 Meas Setting

5.1.1 Meas Type

Set the S parameters type of measurement.

S parameters are used to describe the degree of a transmitted or reflected signal through an impedance discontinuity. S parameters are relative measurements which defined the ratio of two complex voltage and contained the amplitude and phase information of the relevant signals. For SHA800A, two S parameters(S11,S21) can be measured.The syntax for each parameter is described by the following:

S (i|j)

i represents the receiving port of the Instrument (Port 2).The transmitted signal enters the port after passing through the DUT.

j represents the source port of Instrument (Port 1).The output signal of this port is provided to the DUT.

S11 is also called Reflection Measurement.It is used to measure the amount of reflections off the corresponding DUT port.

S21 is also called Transimission Measurement.It is used to measure the loss or the gain through a DUT over a specified frequency range.When conducting S21 measurements, both ends of the DUT must be connected to the device.

Command Format	:CALCulate#:PARAmeter#:DEFine :CALCulate#:PARAmeter#:DEFine?
Instruction	Sets the measure type of VNA Gets the measure type
Parameter Type	Enumeration
Parameter Range	S11,S21
Return	S11 S21
Example	:CALCulate#:PARAmeter#:DEFine S11

5.1.2 Format

The data format is the method by which the vector network analyzer displays the measured data graphically. Select the data format that corresponds to the information you want to know about the test device.

Log amplitude scheme :

Display amplitude (no phase).

Y : dB.

Typical measurements: Return loss,insertion loss or gain

Lin Mag :

Only positive values are displayed.

Y : No Unit (U, suitable for proportional measurement) .

Typical measurements : Reflection and transmission coefficients (amplitude),

Phase format :

The phase of the signal is measured relative to the calibration reference plane, within a range of ± 180 degrees. Each 180-degree trace is “wrapped” for easy scaling

Y: Phase (degrees)

Typical measurement : Linear phase shift.

Note: Phase unwrapping is accomplished by the comparing the phases of two adjacent data points. If the phase difference between two points is greater than 180 degrees, or the DC offset phase of the first data point is greater than 180 degrees, then the phase measurement may not be accurate.

Unwrap phase :

Same phase, but no 180-degree entanglement.

Group delay format :

Displays the transmission (propagation) time of signal in the device

Y: Time (s)

Typical measurement: Group delay

SWR format :

Displays the reflection measurements calculated from the formula $(1+R)/(1-R)$, whrer R is the reflection coefficient. When standing wave ratio is 1, it indicates the DUT matches the device impedance, and energy is transmitted completely without any reflections. When standing wave ratio is ∞ , it indicates the energy is total reflected.

Note: Valid for reflection measurements only

Y: No units

Typical measurements: SWR

Smith circle diagram :

Smith diagrams are a tool for mapping complex reflectance coefficients to test the impedance of equipment. In the Smith chart, the linear impedance plane is reshaped to from a cyclic grid from which the resistance and reactance ($R+jX$) can be read.

The horizontal axis represents the real part of the difference between impedance and resistance. Horizontal axis center always represents the sytem impedance. The rightmost value is infinite ohms (open circuit). The leftmost value is zero ohms (short circuit). The circle intersecting the horizontal axis represents the constant reactance, and the arc tangent to the horizontal axis represents the constant impedance. The upper part of the Smith chart is the area where the

reactance component is positive and therefore inductance is generated, while the lower part is the area where the reactance component is negative and therefore capacitance is generated.

In Smith circle diagram, 5 marker formats are supported: Lin/Phase, Log/Phase, Real/Imag, R+jX, G+jB.

Polar coordinates :

The polar coordinate format is used to view the amplitude and phase of the reflection coefficients in S11 measurements.

The radial line shows the phase angle of the reflected signal. The right-most position corresponds to the zero-phase angle (that is, the reflected signal has the same phase as the incident signal). The phase differences of 90°, ±180°, and -90° correspond to the top, leftmost, and bottom of the polar display, respectively.

In Polar coordinates, 3 marker formats are supported: Lin/Phase, Log/Phase, Real/Imag.

Command Format	:CALCulate#[:SElected]:FORMat :CALCulate#[:SElected]:FORMat?
Instruction	Sets/gets the data format on the selected trace
Parameter Type	enumeration
Parameter Range	MLOGarithmic, MLINear, SWR, PHASe, GDELay, Smith chart: SLINear, SLOGarithmic, SCOMplex, SMITH (R+jX), SADMittance (G+jB)
Return	MLG MLIN SWR PHAS GDEL SMIT POL SLIN SLOG SCOM SMIT SADM PLIN PLOG POL
Example	CALCulate:FORMat SWR

5.1.3 Output power

Output power refers to the output power of the analyzer at **Port 1**. The default output for this setting is 0 dbm, which is the maximum power. In general, when measuring passive high loss device, high output power should be used to facilitate the signal principle noise base. For device that is sensitive to high power levels, such as amplifiers, low output power should be used.

Command Format	:SOURce#:POWer[:LEVel][:IMMEDIATE][:AMPLitude] :SOURce#:POWer[:LEVel][:IMMEDIATE][:AMPLitude]?
Instruction	Set/get the output power
Parameter Type	Float, unitless
Parameter Range	-40dB ~ 0 dB
Return	Float
Example	:SOURce1:POWer -20

5.1.4 Port extension

The port extension function is a good method to eliminate the error of test fixtures. The calibration of S parameters is usually carried out by the user at the plane where the RF cable is connected to the test fixture, typically a connector (SMA, N-type, etc...). The actual device to be tested is located in the test fixture. The device to be tested and the test fixture are generally connected by microstrip line. As a result, the actual measurement plane of the device to be tested does not coincide with the calibration reference plane (the connector, as mentioned previously) which will introduce calibration errors.

After the S parameters calibration is performed, the reference plane can be extended to the specified measurement plane by simply adding the added microstrip line length, speed factor, loss, and other parameters in the setting interface, to carry out more accurate testing.

Manual port extension operation steps :

1. Perform the appropriate calibration type on the associated cabling before entering Port Extensions.
2. Select **Meas** -> **Port Extension** to enter the Settings menu.
3. Select the port that needs to be extended, input the velocity factor. Different speed coefficients lead to different transmission speeds of the electromagnetic waves in transmission lines and different transmission time.

Notes: Input the length of the transmission line and the port delay will be automatically calculated, and input the port delay time then the length will be automatically calculated.

Command Format	:CORRection:EXTension :CORRection:EXTension?
Instruction	Set/get the port extension state
Parameter Type	Boolean
Parameter Range	OFF ON 0 1
Return	0 1
Example	:CORRection:EXTension ON

Command Format	:CORRection:EXTension:PORT[1] 2:TIME :CORRection:EXTension:PORT[1] 2:TIME?
Instruction	Set/get the Electric delay
Parameter Type	Float, Unit:s
Parameter Range	-10s ~10s
Return	Float
Example	:CORRection:EXTension:PORT1:TIME 0.0002

Command Format	:CORRection:EXTension:AUTO:PORT
Instruction	Set the port1 auto extension
Example	:CORRection:EXTension:AUTO:PORT

Command Format	:CORRection:RVELOCITY:COAX :CORRection:RVELOCITY:COAX?
Instruction	Set/get the Velocity factor
Parameter Type	Float
Parameter Range	0.1~1
Return	Float
Example	:CORRection:RVELOCITY:COAX 0.2

5.2 Frequency range

Frequency range is the span of frequencies you specify for making a device measurement.

Note:

Center: Specify a center frequency of the swept measurement range

Start: Specify the starting frequency of the swept measurement range

Stop: Specify the end frequency of the swept measurement range

Span: Specify the swept measurement frequency range. When setting the frequency span, it will set start/stop frequency around center. It can also be set to zero span. When switching to Zero span mode, it will memorize the current span and set to center frequency. When it is set to Span mode again, it will resume the last frequency range.

Command Format	:FREQUENCY:START :FREQUENCY:START?
Instruction	Sets the start frequency Gets the start frequency
Parameter Type	Float, unit: Hz, kHz, MHz, GHz
Parameter Range	100KHz~7.4999999GHz Zero Span: 100.5KHz~7.5GHz
Return	Float, unit:Hz
Example	:FREQUENCY:START 1.0GHz

Command Format	:FREQUENCY:STOP :FREQUENCY:STOP?
Instruction	Sets the stop frequency Gets the stop frequency
Parameter Type	Float, unit: Hz, kHz, MHz, GHz
Parameter Range	100.1KHz~7.5GHz Zero Span: 100.5KHz~7.5GHz
Return	Float, unit:Hz
Example	:FREQUENCY:STOP 1.0GHz

Command Format	:FREQUENCY:SPAN :FREQUENCY:SPAN?
-----------------------	---

Instruction	Sets the frequency span.Setting the span to 0 Hz puts the analyzer into zero span Gets span value
Parameter Type	Float, unit: Hz, kHz, MHz, GHz
Parameter Range	0Hz, 100Hz~7.499999GHz
Return	Float, unit:Hz
Example	:FREQuency:SPAN 1.0GHz

Command Format	[[:SENSe#]:FREQuency:SPAN:ZERO [:SENSe#]:FREQuency:SPAN:SWEPT [:SENSe#]:FREQuency:SPAN:ZERO?
Instruction	Sets the frequency span to zero span Sets the frequency span to last span Gets whether current span is zero span
Return	Float, unit:Hz
Example	:FREQuency:STOP 1.0GHz

5.3 BW

Use averaging to help smooth a trace and reduce the effects of random noise on a measurement. It will average the multiple sweep results of every point according to the average times setting.The higher the number of average times, the more dandom noise is eliminated.

Click **BW→Averaging/Avg Times** to enable averaging and set average times.

When the Averaging is enabled, the number of sweeps currently used for averaging and the average times are displayed on the left statusbar.

Command Format	[[:SENSe#]:AVERAge[:STATe] [:SENSe#]:AVERAge[:STATe]?
Instruction	Set/query the average state
Parameter Type	Boolean
Parameter Range	OFF ON 0 1
Return	0 1
Example	:Average 1

Command Format	[[:SENSe#]:AVERAge:COUNT [:SENSe#]:AVERAge:COUNT?
Instruction	Set/query the average number
Parameter Type	Integer
Parameter Range	1~999
Return	Integer
Example	:Average:COUNT 25

5.4 Sweep

5.4.1 Points

Data points are the number of data samples representing the measured values at a single excitation value. When specifying the sweep points, the sweep time of the vector network analyzer varies proportionally with the number of points. More sweep points will increase measurement resolution, affect the minimum sweep time, increase the time of both data processing and remote access to data, and reduce the response rate as well.

The number of data points collected by the network analyzer during the measurement sweep can be set to any number between 101 and 10001.

5.4.2 Sweep Time & Sweep Time Rules

Sweep time is automatically set according to the Sweep points by default. When Sweep time mode is auto, the fastest response time that analyzer need to configure the hardware and collect every single point data is calculated and applied.

When measuring long lengths of cable, you can slow the sweep time so that more stable and reliable waveform can be observed.

Note: Setting the sweep time manually will change the sweep time mode.

Command Format	:SWEep:TIME :SWEep:TIME?
Instruction	Specifies the time in which the instrument sweeps the display. A span value of 0 Hz causes the analyzer to enter zero span mode. In zero span the X-axis represents time rather than frequency
Parameter Type	Float, unit: ks, s, ms, us
Parameter Range	1us ~ 1500s
Return	Float, unit:s
Example	:SWEep:TIME 5s

Command Format	:SWEep:TIME:AUTO OFF ON 0 1 :SWEep:TIME:AUTO?
Instruction	This command turn on/off auto sweep time state
Parameter Type	Boolean
Parameter Range	OFF ON 0 1
Return	0 1
Example	:SWEep:TIME:AUTO ON

5.4.3 Sweep/Measure

Sweep/Measure:

Single/Continue, controls analyzer to perform single or continuous sweep/measure. This setting is Continue by default.

Restart:

Restart the current sweep or measure. In particular, if the sweep parameters are modified, a restart will be performed. Sweep parameters include frequency, sweep, average settings.

Command Format	:INITiate:CONTInuous OFF ON 0 1 :INITiate:CONTInuous?
Instruction	Sets continuous sweep mode on-off. Gets continuous sweep mode state.
Parameter Type	Boolean
Parameter Range	OFF ON 0 1
Return	0 1
Example	:INITiate:CONTInuous OFF

Command Format	:INITiate[:IMMEDIATE]
Instruction	Restart the current sweep.
Example	:INITiate:IMMEDIATE

5.5 Amplitude

5.5.1 RF Atten

Set the RF attenuation of **Port2** in S21 measurement so that receiver distortion caused by high-power measurement can be avoided.

5.5.2 Y Axis

Use the settings “Scale”, “Reference Level”, and “Reference Position” Settings (as well as the format) determine how the data trace will appear on the analyzer screen.

5.5.2.1 Scale

Sets the vertical indexing value of the rectangular coordinate display format. In polar coordinates and Smith chart formats, the scale sets the value of the outer perimeter.

Range: 0.001 dB/div to 1000 dB/div

Command Format	:DISPlay:WINDow#:TRACe 1 2 3 4 :Y[:SCALe]:PDIVision :DISPlay:WINDow#:TRACe 1 2 3 4 :Y[:SCALe]:PDIVision?
Instruction	Sets/gets the scale on selected trace
Parameter Type	Float
Parameter Range	0.001 dB ~ 1000 dB
Return	Float, unit dB
Example	:DISPlay:WINDow:TRACe:Y:PDIVision 10 dB

5.5.2.2 Reference level

Sets the value of the guide in rectangular format. In polar coordinates and Smith's circle chart formats. The reference level does not apply.

Range: -1000 dB to 1000 dB

Command Format	:DISPlay:WINDow#:TRACe 1 2 3 4 :Y[:SCALe]:RLEVel :DISPlay:WINDow#:TRACe 1 2 3 4 :Y[:SCALe]:RLEVel?
Instruction	Sets/gets the reference level on selected trace
Parameter Type	Float
Parameter Range	0.001 dB ~ 1000 dB
Return	Float, unit dB
Example	:DISPlay:WINDow:TRACe:Y: RLEVel 10 dB

5.5.2.3 Reference position

Sets the position of the guide in Rectangular coordinate format. Zero is the bottom line and 10 is the top line. The default position is 5 (middle of the screen). Reference positions do not apply in polar coordinates and Smith chart formats.

Command Format	:DISPlay:WINDow#:TRACe#:Y[:SCALe]:RPOStion :DISPlay:WINDow#:TRACe#:Y[:SCALe]:RPOStion?
Instruction	Sets/gets the reference position on selected trace
Parameter Type	Int
Parameter Range	0~ 10
Return	Int
Example	:DISPlay:WINDow:TRACe:Y: RPOStion 5

5.5.3 Auto Scaling

Automatic scaling:

Automatically sets the vertical indexing value and reference value to fit the working data trace in the screen grid area. The reference position is not affected. The analyzer determines the minimum possible scaling factor that will allow all display data to appear on the 80% vertical grid. The selected reference values center the trace on the screen.

Command Format	:DISPlay:WINDow#:TRACe[1] 2 3 4 :Y[:SCALe]:AUTO
Instruction	Do auto scale on selected trace
Example	:DISPlay:WINDow:TRACe2:Y:AUTO

All autoscaling:

Automatically scales all data traces in the working window to fit vertically into the grid area of the screen.

5.6 Trace

5.6.1 Num of Traces

In Vector Network Analyzer mode, the analyzer allows for up to four traces to be displayed at the same time. Each trace has its own color (Trace 1 – Yellow, Trace 2 – Purple, Trace 3 – cyan, Trace 4 – Green). Select specific trace to set parameter independently.

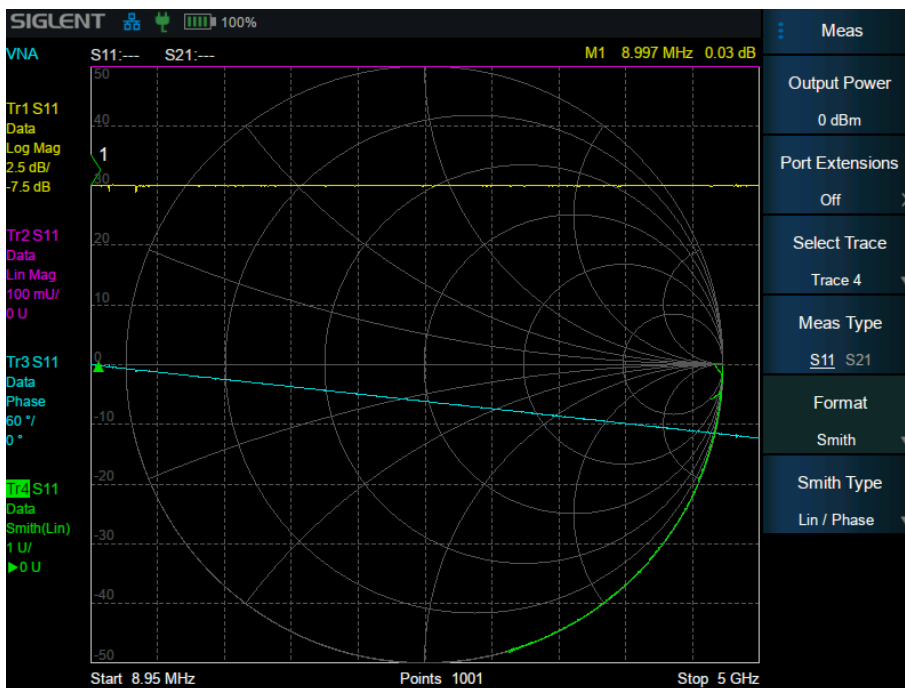

Figure 5-1 trace

As shown in the figure, Multiple traces are stacked and displayed in the waveform area. Basic information of each trace is shown on the left and it is a shortcut to perform quick operation and set trace parameters. The coordinate axis of waveform area will stay consistent with the current selected trace.

Command Format	:CALCulate#:PARAmeter:COUNT :CALCulate#:PARAmeter:COUNT?
Instruction	Sets/gets the number of the traces
Parameter Type	int
Parameter Range	1~4
Example	:CALCulate:PARAmeter:COUNT 1

5.6.2 Select Trace

Select certain trace to configure the corresponding trace settings like Format, Display Type, etc.

Command Format	:CALCulate#:PARAmeter:SElect
Instruction	Sets current selected trace

Parameter Type	Enumeration
Parameter Range	TRACE1 TRACE2 TRACE3 TRACE4 A B C D 1 2 3 4
Return	TRACE1 TRACE2 TRACE3 TRACE4
Example	:CALCulate:PARAmeter:SElect 1

5.6.3 Memory Trace

The analyzer supports saving the current data-trace in memory. It can perform four kinds of mathematical operations on the current data-trace and memory trace. When the mathematical operation with memory trace needs to be carried out, the current data needs to be stored in memory first.

5.6.3.1 Trace Type

Go to **Trace** menu, Click **Data**→**Memory** to complete the storage operation.

Command Format	:CALCulate#[[:SElected]:MATH:MEMorize
Instruction	Memorize the data from current trace
Example	:CALCulate:MATH:MEMorize

If memory trace data was valid, In the Display menu bar, you can select four display modes: Display data-trace only, display memory trace ,display data-trace and memory trace at the same time and display off.

Command Format	:DISPlay:WINDow#:TRACe 1 2 3 4:STATe :DISPlay:WINDow#:TRACe 1 2 3 4:STATe?
Instruction	Sets/gets data-trace to open or off
Parameter Type	Boolean
Parameter Range	OFF ON 0 1
Return	0 1
Example	:DISPlay:WINDow:TRACe2:STATe 1

Command Format	:DISPlay:WINDow#:TRACe 1 2 3 4:MEMory[:STATe] :DISPlay:WINDow#:TRACe 1 2 3 4:MEMory[:STATe]?
Instruction	Sets/gets mem-trace to open or off
Parameter Type	Boolean
Parameter Range	OFF ON 0 1
Return	0 1
Example	:DISPlay:WINDow:TRACe2:MEMory 1

5.6.3.2 Math

The four mathematical operations of data-trace and memory trace are as follows, in which the values on data-trace and memory trace are linear:

Data/Memory: Divide the measured data by the data in the stored trace. This function can be used to calculate the ratio of two traces (such as calculating gain or attenuation), which can also be regarded as the normalization operation of test data.

Data*Memory: The current measurement data is multiplied by the data in memory.

Data+Memory: Current measurement data plus data in memory.

Data-Memory: Current measurement data minus data in memory. For example, you can use this function to store measured data. The error is then subtracted from the DUT measurement.

Command Format	:CALCulate#[:SElected]:MATH:FUNCtion OFF DIVide MULtiplY SUBtract ADD :CALCulate#[:SElected]:MATH:FUNCtion?
Instruction	Sets/gets mathematical operations on current trace
Parameter Type	Enumeration
Parameter Range	OFF DIVide MultiplY SUBtract ADD
Return	Enumeraiton, OFF DIVide MULtiplY SUBtract ADD
Example	:CALculate:MATH:FUNC DIVide

5.6.4 Hold Trace

Trace hold types include Clear Write, Max Hold. Using this function, The system calculates the sampled data using a specific operation method according to the trace hold type selected operation and displays the result.

- Clear Write: Erases any data previously stored in the selected trace, and display the data sampled in real-time of each point on the trace.
- Max Hold: Retain the maximum level for each point of the selected trace. Update the data if a new maximum level is detected in successive sweeps.
- Min Hold: Display the minimum value from multiple sweeps for each point of the trace and update the data if a new minimum is generated in successive sweeps.

Based on frames, trace hold calculation operate new data and historical data point by point. Therefore modifying trace hold type, frequencies, points and other parameters will cause sweep to restart and recalculate. The first frame after rescanning is considered as no historical data, and the Clear Write logic is implemented by default.

Command Format	:TRACe 1 2 3 4:HOLD :TRACe 1 2 3 4:HOLD?
Instruction	Sets/gets trace hold type
Parameter Type	Enumeration
Parameter Range	OFF MAX MIN
Return	Enumeraiton, OFF MAX MIN
Example	TRACe1:HOLD MAX

5.7 Marker & Peak

5.7.1 Marker Settings

The marker appears as a rhombic sign for identifying points on a trace. You can easily read the amplitude, frequency of the marked point on the trace. The analyzer allows for up to seven markers and one reference marker to be displayed on one trace.

5.7.1.1 Select Marker

Press the **Marker** button on the front panel and go to Marker menu. If there is no active marker, Marker1 will be automatically turned on. Click **Select Marker** to select desired marker. When a marker is selected, you can set its type, trace to be marked, X values and other related parameters. The enabled marker will appear on the trace selected through the **Select Trace** option and the measurement value of the marker will be displayed at the top right of the window, the value format is the same as the format of the trace.

5.7.1.2 Marker Type

Three types of marker are supported as follow:

Normal:

It is used to measure the X (Frequency or Time) and Y (Amplitude) values of a certain point on the trace. When selected, a marker with the number of the current marker (such as "1") appears on the trace. If there is no active marker exists currently, a marker will be enabled automatically at the center frequency of the current trace. If selected marker has been opened and configured before, reopen the marker will set to the previous X values.

Note: The readout resolution of the X-axis (frequency or time) is related to the span. For higher readout resolution, reduce the span.

Delta:

It is used to measure the delta values of X (Frequency or Time) and Y (Amplitude) between the reference point and a certain point on the trace. When selected, a pair of markers appear on the trace Fixed Reference marker (marked by letter "R") and the Delta Marker (marked by the "Δ", such as "Δ1")

Note: After the marker selects "Delta", the original marker will become the delta measurement marker, and the reference marker will automatically turn on. The readout information on current Delta marker will show the frequency (or time) difference and amplitude difference compared to the Reference Marker's value.

Off:

Turn off the marker currently selected. The marker information displayed on the screen and functions based on the marker will also be turned off.

Command Format	:CALCulate:MARKer[1] 2 3 4 5 6 7 8:MODE :CALCulate:MARKer[1] 2 3 4 5 6 7 8:MODE?
Instruction	Sets/gets marker type
Parameter Type	Enumeration
Parameter Range	POSition DELTA OFF
Return	POS DELTA OFF
Example	:CALCulate:MARK1:MODE POSition

Command Format	:CALCulate:MARKer[1] 2 3 4 5 6 7 8:STATe :CALCulate:MARKer[1] 2 3 4 5 6 7 8:STATe?
Instruction	Sets/gets marker on/off state
Parameter Type	Boolean
Parameter Range	OFF ON 0 1
Return	0 1
Example	:CALCulate:MARK1:STATe ON

Note: Marker 8 equals reference marker, which can not be set to Delta Marker type.

Command Format	:CALCulate:MARKer:AOFF
Instruction	Sets all marker type to Off
Example	:CALCulate:MARKer:AOFF

5.7.1.3 Marker X

Displays and sets the x-axis position of the marker. The unit of readout values is identical to the current x-axis. For instance, When the span mode is zero span, the unit is time, and when the span mode is span, the unit is frequency.

When setting marker X value, it can only be set within the range of the current X axis. When the measurement range/span changes, the exceeding Marker will be set to the current measurement start value or stop value, depending on whether the Marker X value exceeds the start value or stop value.

Command Format	:CALCulate:MARKer[1] 2 3 4 5 6 7 8:X :CALCulate:MARKer[1] 2 3 4 5 6 7 8:X?
Instruction	Sets/gets marker X value This command is effective only when the marker mode is not Off Use command below to set marker mode/type: :CALCulate:MARKer[1] 2 3 4 5 6 7 8:STATe :CALCulate:MARKer[1] 2 3 4 5 6 7 8:MODE
Parameter Type	Frequency, Float, Unit Hz, kHz, MHz, GHz, default to Hz Time, Float, Unit us, ms, s, ks, default to s
Parameter Range	100kHz to max frequency or 10ms ~ 1000s
Return	Frequency, Float, Unit Hz; Time, Float, Unit s;
Example	:CALCulate:MARKer4:X 0.4 GHz :CALCulate:MARKer4:X 200 ms :CALCulate:MARKer4:X?

Command Format	:CALCulate:MARKer[1][2][3][4][5][6][7][8]:Y?
Instruction	gets marker Y value When the data format is Smith/Polar, there are multiple returned values depending on the specific Smith/Polar Type.
Return	LogMag, Float, unit dB; Phase, Float, unit degree; SWR, Float, unitless(U); Group Delay, Float, time(s); LinMag, Float, unitless(U)
Example	:CALCulate:MARKer1:Y? Return : -25

5.7.1.4 Marker Couple

When Marker Couple is on, Markers are set up and moved in coupled operation on all traces.

When Marker Couple is off, Markers are set up and moved independently for each trace.

Command Format	:CALCulate[:SElected]:MARKer:COUple :CALCulate[:SElected]:MARKer:COUple?
Instruction	Sets/gets Marker Couple on/off state
Parameter Type	Boolean
Parameter Range	OFF ON 0 1
Return	0 1
Example	:CALCulate:MARKer:COUple 1 :CALCulate:MARKer:COUple?

5.7.2 Marker Function

The marker function provides a method for further processing the current marker data to achieve specific results or make the measurement results more accurate.

5.7.2.1 N dB BW

Enable the N dB BW measurement or set the value of N dB. The N dB BW denotes the frequency difference between two points that are located on both sides of the current marker and with N dB fall (N Less than or equal to 0) or rise (N>0) in amplitude as shown in the figure on the next page.

When the measurement starts, the analyzer will search for the two points which are located at both sides of the current point with N dB fall or rise in amplitude and display the frequency difference between the two points in the active function area. "----" would be displayed if the search fails.

The parameters in the figure are shown as:

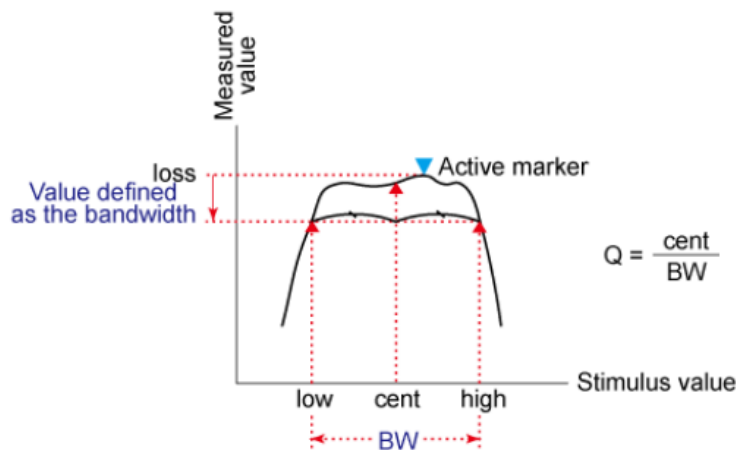

Figure 5-2 N dB marker

Note: When the N dB BW function is turned on, if the current marker is off, the marker type of the current selected marker will automatically change to Normal. The function will be closed if the marker is turned off.

Command Format	:CALCulate:MARKer[1] 2 3 4 5 6 7 8:BANDwidth:NDB :CALCulate:MARKer[1] 2 3 4 5 6 7 8:BANDwidth:NDB?
Instruction	Sets/gets Marker N ddB BW N value
Parameter Type	LogMag, Float, Unit dB; Phase, Float, Unit degree; LinMag, Floag Unitless U;
Parameter Range	LogMag, -100 dB to 100 dB; LinMag, -100 kU to 100 kU; Phase, -360°to 360°;
Return	Float
Example	:CALCulate:MARK1:BANDwidth:NDB 10 dB

Command Format	:CALCulate:MARKer[1] 2 3 4 5 6 7 8:BANDwidth:RESult?
Instruction	Gets the result of N dB BW calculation
Return	Float
Example	:CALCulate:MARK1:BANDwidth:RESult?

5.7.2.2 Discrete Marker

Due to the limited number of ampling points set on the trace, the data of other points except the sampling points are based on the interpolation value of the sampling point data, which is approximate to the actual data, not the real measured data. By setting Discrete Marker, the value of the marker can only be taken at sampling point, which ensures that the marker's value is from the measurement data and not interpolated data.

Click the **Discrete** to select the **On** option, at this time, the data of the marker is only selected from the sampling point. This setting is default to Off.

Command Format	:CALCulate[:SElected]:MARKer[1] 2 3 4 5 6 7 8:DIScrete :CALCulate[:SElected]:MARKer[1] 2 3 4 5 6 7 8:DIScrete?
Instruction	Sets/gets Marker Discrete function state
Parameter Type	Boolean
Parameter Range	ON OFF 0 1
Return	0 !
Example	:CALCulate:MARK1:DIScrete 1

5.7.2.3 Marker→

Set Other Parameters according to current Marker.

Marker→Center Freq:

Set the center frequency of the analyzer to the frequency of the current marker.

Command Format	:CALCulate:MARKer[1] 2 3 4 5 6 7 8[:SET]:CENTer
Instruction	Set the marker position (X coordinate) as the center frequency. Valid when the marker is on.
Example	:CALCulate:MARKer1:CENTer

Marker→Start Freq:

Set the start frequency of the analyzer to the frequency of the current marker.

Command Format	:CALCulate:MARKer[1] 2 3 4 5 6 7 8[:SET]:START
Instruction	Set the marker position (X coordinate) as the start frequency Valid when the marker is on.
Example	:CALCulate:MARKer1:START

Marker→Stop Freq:

Set the stop frequency of the analyzer to the frequency of the current marker.

Command Format	:CALCulate:MARKer[1] 2 3 4 5 6 7 8[:SET]:STOP
Instruction	Set the marker position (X coordinate) as the stop frequency Valid when the marker is on.
Example	:CALCulate:MARKer1:STOP

Note: Functions listed above are not available in Zero span.

Δ Marer→Span:

This function is only available when the current marker is a Delta Marker. Set the sweeping range between the current marker position and the reference marker position (frequency).

Command Format	:CALCulate:MARKer[1] 2 3 4 5 6 7 8:DELTA[:SET]:SPAN
Instruction	Sets the difference between the delta marker and reference marker to current sweep span Use Command below to set marker type to DELTA:

	:CALCulate:MARKer[1] 2 3 4 5 6 7 8:MODE
Example	:CALCulate:MARKer2:DELTA:SPAN

5.7.3 Peak

5.7.3.1 Peak Search

Open the peak setting menu and execute peak search. Press **Peak** to search for positive value which is greater than the measured value at both ends of a span. Press **Valley** to perform the oppsite search.

Command Format	:CALCulate:MARKer[1] 2 3 4 5 6 7 8:MAXimum
Instruction	Marker searches for peaks on the selected trace and marks them with the current selected marker
Example	:CALCulate:MARKer4:MAXimum

Command Format	:CALCulate:MARKer[1] 2 3 4 5 6 7 8:Minimum
Instruction	Marker searches for valleys on the selected trace and marks them with the current selected marker
Example	:CALCulate:MARKer4:Minimum

5.7.3.2 Continuous Peak/Valley

Enable or disable continuous peak search. The default is Off. When enabled, the system will always execute a peak search automatically after each sweep in order to track the signal under measurement.

Note: Each trace only supports one pair of marker to perform continuous peak/valley. For example, if certain marker is doing Continuous Peak, set other marker **Continuous Peak** to on will automatically set the previous one to **Off**.

Command Format	:CALCulate:MARKer[1] 2 3 4 5 6 7 8:CPSearch[:STATE] :CALCulate:MARKer[1] 2 3 4 5 6 7 8:CPSearch[:STATE]?
Instruction	Sets/gets Marker Continue Peak Search On/Off state
Parameter Type	Boolean
Parameter Range	ON OFF 0 1
Return	0 !
Example	:CALCulate:MARKer1:CPSEarch ON

Command Format	:CALCulate:MARKer[1] 2 3 4 5 6 7 8:CVSearch[:STATE] :CALCulate:MARKer[1] 2 3 4 5 6 7 8:CVSearch[:STATE]?
Instruction	Sets/gets Marker Continue Valley Search On/Off state
Parameter Type	Boolean

Parameter Range	ON OFF 0 1
Return	0 !
Example	:CALCulate:MARKer1:CVSEarch ON

5.7.3.3 Peak→

Peak→Center: Perform a peak search on the current marker and set the marker frequency to center frequency.

Valley→Center: Perform a valley search on the current marker and set the marker frequency to center frequency.

5.8 Limit

Limit Line is a test form that can visualize test data and results. The limit test compares the measured data with the defined limit and provides the qualified or unqualified judgment information of each measured data point. Limit line and limit test are only available in LogMag/LinMag data format. When the trace that has limit working on switching to other data format, the limit will automatically set to disable.

Command Format	:CALCulate:LLINe[1]]2:STATe OFF ON 0 1 :CALCulate:LLINe[1]]2:STATe?
Instruction	Sets/gets limit test on/off state
Parameter Type	Boolean
Parameter Range	ON OFF 0 1
Return	0 !
Example	:CALCulate:LLINe1:STATe OFF

5.8.1 Limit Edit

Click **Limit** to the limit menu, Enable certain Limit so that **Limit Edit** submenu is valid. In **Limit Edit**, you can set limit type, limit mode and modify/ load/ save the limit data.

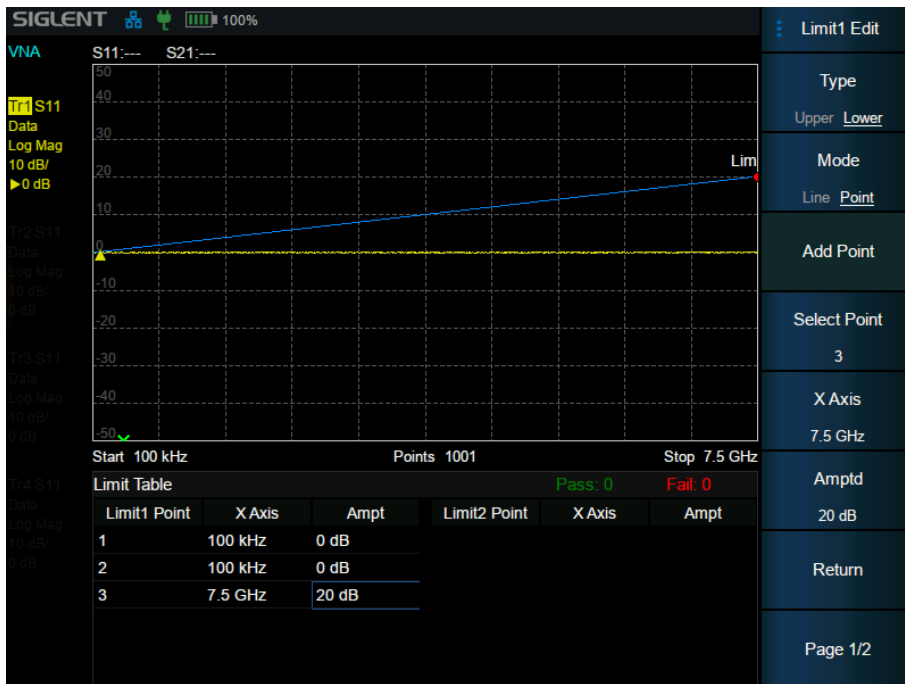

Figure 5-3 limit edit

Limit Type:

Set the limit type as upper/lower. This setting is default to **Upper**.

Command Format	:CALCulate:LLINE[1][2]:TYPE :CALCulate:LLINE[1][2]:TYPE?
Instruction	Sets/gets limit type
Parameter Type	Enumeration
Parameter Range	UPPer LOWer
Return	UPP LOW
Example	:CALCulate:LLINE1: UPPer

Limit Mode:

Set Whether the limit line is a straight flat line or a polyline connected by limit points. This setting is default to **Line**.

When the limit mode is **Line**, only setting the limit line amplitude is required. When the limit mode is **Point**, Use add/delete point button in the menu, and set both X and Y value of each point by selecting the specific limit point or directly touch the screen in the limit table to select and set points. After changing the X value of a limit point, the limit points list will be sorted from small to large by X value.

Use the following command to set limit mode:

Command Format	:CALCulate:LLINE[1][2]:MODE :CALCulate:LLINE[1][2]:MODE?
Instruction	Sets/gets limit mode
Parameter Type	Enumeration

Parameter Range	LINE POINT
Return	LINE POINT
Example	:CALCulate:LLINe1: UPPer

Use the following command to set limit line amplitude:

Command Format	:CALCulate:LLINE[1]2:LINE :CALCulate:LLINE[1]2:LINE?
Instruction	Sets/gets limit line amplitude value
Parameter Type	Float
Parameter Range	-150 ddB to 150
Return	Float
Example	:CALCulate:LLINe1:LINE 50

Use the following command to add/set limit point data,

Command Format	:CALCulate:LLINe[1]2:POINT#:DATA val1,val2 :CALCulate:LLINe[1]2:POINT#:DATA? :CALCulate:LLINe[1]2:POINT:ADD val1,val2
Instruction	Sets/gets a specific point data,if point index is greater than the list size, the command will not take effect. Add a point after the current points list
Parameter Type	val1:Float,frequency val2:Float,amplitude
Parameter Range	val1:related with Span val2:-150 to 150
Return	val1:Float,frequency val2:Float,amplitude
Example	:CALCulate:LLINe2:POINT:ADD 100,-20,200,-25 That means add two points: (100,-20) , (200, -25) :CALCulate::LLINe2:POINT4: 100,-20 That means change point4 to (100,-20)

Use the following command to set all limit points

Command Format	:CALCulate:LLINe[1]2:POINTs :CALCulate:LLINe[1]2:POINTs?
Instruction	Sets/gets all limie points This command will erase the previous limit points and set with input values
Parameter Type	val1:Float,frequency val2:Float,amplitude
Parameter Range	val1:related with Span val2:-150 to 150
Return	val1:Float,frequency val2:Float,amplitude
Example	:CALCulate:LLINe2:POINTs 100,-20,200,-25,300,-30

Use the following command to delete limit point/points:

Command Format	:CALCulate:LLINe#:POINT#:DELeTe :CALCulate:LLINe#:POINTs:DELeTe
Instruction	Delete certain limit's certain/all limit points
Example	:CALCulate:LLINe1:POINT1:DELeTe :CALCulate:LLINe1:POINTs:DELeTe

5.8.2 Limit Test

Limit Test: According to the Enabled limit, start/stop test on the selected trace.

- If limit Test is set **On**, a pass/fail sign will appear on top of grid area which indicates whether the current trace passed the limit test. When there are two limits taking effect on different trace, the limit result will be result1 & result2.
- If you add two limit points and the X values are the same but Y values are not, the smaller Y value will be tested when the limit type is **Upper** and otherwise the opposite.

Command Format	:CALCulate:LLINe:TEST :CALCulate:LLINe:TEST?
Instruction	Sets/gets the on/off state of limit test switch
Parameter Type	Boolean
Parameter Range	OFF ON 0 1
Return	0 1
Example	:CALCulate"LLINe:TEST 1

Command Format	:CALCulate:LLINe[1]]2]:FAIL?
Instruction	Query the current result of certain limit
Return	0 1
Example	:CALCulate:LLINe2:FAIL1

5.8.2.1 Buzzer

Open/close buzzer function. When the Buzzer is set to **On** and the test result is fail, buzzer will make a short beep.

Command Format	:CALCulate:LLINe:CONTRol:BEEP :CALCulate:LLINe:CONTRol:BEEP?
Instruction	Sets/gets the Buzzer on/off state
Parameter Type	Boolean
Parameter Range	OFF ON 0 1
Return	0 1
Example	:CALCulate:LLINe:CONTRol:BEEP OFF

Attention: If the Buzzer is set to **off** in system settings, despite turning on the buzzer in limit test, it will not beep when test fails.

5.8.2.2 Fail to Stop

This Function meets the demand to observe the failure result. When the fail to stop is set to on and the test fails, it will stop the sweep.

Command Format	:CALCulate:LLINe:FAIL:STOP :CALCulate:LLINe:FAIL:STOP?
Instruction	Set/get the fail to stop state
Parameter Type	Boolean
Parameter Range	OFF ON 0 1
Return	0 1
Example	:CALCulate:LLINe:FAIL:STOP OFF

5.9 Calibration

Due to the systematic errors, cabling, adapters, probes and more, the DUT usually can't be measured directly and accurately. These errors are caused by leakage signals inside the instrument, by the frequency response of the receivers, and by reflections inside the instrument that interact with the DUT. It is necessary to introduce calibration compensation to help achieve higher accuracy. After calibration, the S parameter calibration is applied to the calculation results and the errors are removed from subsequent measurements.

5.9.1 Definitions

DUT(Devie Under Test)The Cable, antenna, transmission line, amplifier, filter, or anything else that is connected to the SHA802X that is to be measured.

Calibration Standards – **OPEN, SHORT, LOAD, and THRU**

OPEN,SHORT, and LOAD are 'reflection' standards that are used during calibration. When an RF signal 'hits' these components, the signals are reflected in a predictable manner. These components can also be used to terminate a DUT port during some measurements.

SHORT and **OPEN** standards both cause 100% of an RF signal to be reflected. The difference between these two standards is what happens to the phase of the reflected signal. Although an **OPEN** standard is a precision component, simply leaving **nothing** connected at the end of a cable can be a reasonable substitute for an **OPEN**.

A **LOAD** standard absorbs almost ALL of the incident signal and very little signal is reflected back to the source.

A **THRU** standard is used during some calibration steps to connect PORT1 to PORT2 in place of the DUT. A Flush THRU connection can be made when the cables that connect with the DUT can mate with each other. Otherwise, any reasonably short cable can be used as a THRU standard.

Calbration Reference Plane is the point(or points) at which the DUT and cal standards are connected during a calibration. This can be at the FiedFox test port connectors, or at the end of jumper cables or adapters.

5.9.2 Calibration Kit

5.9.2.1 Standard Cal Kit

SHA800A provides a variety of default calibration kit standards, including **F503, F603, F504, F604, 85032F, 85032B/E, 85032D/E**.

Select correct Cal Kit gender so that correct Cal Kit data is applied in calibration. Please refer to the data manual of coaxial calibration kit for detailed Cal Kit parameters and applicable scenarios.

The Document URL is as follow:

https://siglentna.com/wp-content/uploads/dlm_uploads/2021/04/Mechanical-Calibration-Kit-Datasheet-v1.4.pdf

Command Format	:CORRection:COLLect:CKIT:LABel :CORRection:COLLect:CKIT:LABel?
Instruction	Set/get the current cal kit
Parameter Type	enumeration
Parameter Range	"F503E" , "F603E" , "F504S" , "F604S" , "85032F" , "85032B/E" , "85033D/E" "User1" , "User2"
Return	enumeration
Example	:CORRection:COLLect:CKIT:LABel "85032F"

Command Format	:CORRection:COLLect:CKIT:GENDer :CORRection:COLLect:CKIT:GENDer?
Instruction	Sets/gets the male/female properties of the current calibration suite
Parameter Type	enumeration
Parameter Range	MALE FEMAlE
Return	enumeration
Example	:CORRection:COLLect:CKIT:GENDer MALE

5.9.2.2 User Kit

When the user are using standards (or combinations of standards) that are different from the predefined standard Cal Kits, for example, using three offset SHORTS instead of an OPEN, SHORT, and Load to perform a 1-port calibration, it requires users to create custom User calibration kits.

Operation Instructions:

Press **Cal** -> **Cal Kit** -> **User1/User2**, edit types, delays and OPEN/SHORT standard samples to create cusrom kit.

5.9.3 Calibration Type

5.9.3.1 Open Response Calibration

when a single port is used for open-circuit response calibration, the reflection tracking error in the error model of the test device can be calculated by only connecting the OPEN calibration element or even simply NOTHING to the test port. If the Load calibration element is used for isolation calibration at the same time, the directional error can be calculated.

Calibration Steps :

1. **Preset** the instrument.
2. Set internal source output power, sweep points, test frequency band , Cal Kit and other parameters.
3. Select Cal -> Calibrate -> Open Cal
4. Connect the OPEN calibration element to the test port according to the interface prompts, click **Open** for calibration, and click **Finish** to exit the calibration interface after calibration, complete the calibration, and save the calibration data.

5.9.3.2 Short Circuit Response Calibration :

Like the open-circuit response calibration, the single-port short-circuit response is connected to the port with the SHORT calibration element, and the reflection tracking error can be calculated. If the Load calibration element is used for isolation calibration at the same time, the directional error can be calculated.

Calibration Steps :

1. **Preset** the instrument.
2. Set internal source output power, sweep points, test frequency band, Cal Kit and other parameters.
3. Select Cal -> Calibrate -> Short Cal
4. Connect the SHORT calibration element to the Port 1 according to the interface prompts, click **Short** for calibration, and click **Finish** to exit the calibration interface after calibration, complete the calibration, and save the calibration data.

5.9.3.3 Full 1-Port OSL calibration :

All 1-port OSL calibration connects the OPEN, SHORT, and LOAD calibration elements to the test ports in turn to calculate the reflection tracking error, directional error, and source matching error in the error model of the test device.

Calibration Steps :

1. **Preset** the instrument.

2. Set internal source output power, sweep points, test frequency band , Cal Kit and other parameters.
3. Select Cal -> Calibrate -> 1-Port Cal
4. Connect the OPEN calibration element to the Port 1 according to the interface prompts and click **Open** for calibration. Wait till the sweep is complete then connect the SHORT calibration element to the Port 1, click **Short** for calibration. Wait till the sweep is complete then connect the LOAD calibration element to the Port 1, click the **Load** for calibration. After the calibration, click FINISH to exit the calibration inter face , complete the calibration, and save the calibration data.

5.9.3.4 Transimission Response Calibration:

Two-port transmission response calibration is to connect the THRU calibration kit between Port1 and Port2 to calculate the transmission tracking error in the test device error model.

Calibration Steps :

1. **Preset** the instrument.
2. Set internal source output power, sweep points, test frequency band , Cal Kit and other parameters.
3. Select Cal -> Calibrate -> Response-Thru Cal
4. Connect the THRU calibration element between Port1 and Port2, click **Thru** for calibration, and click **Finish** to exit the calibration interface, complete the calibration, and save the calibration data.

5.9.3.5 Enhanced Response Calibration:

Two-port enhanced response calibration connects the Thru calibration element between two ports, and connects the Open, Short, and Load on one port for calibration.

Calibration Steps :

1. **Preset** the instrument.
2. Set internal source output power, sweep points, test frequency band , Cal Kit and other parameters.
3. Select Cal -> Calibrate -> Enhanced-Res Cal
4. Connect OPEN, SHORT, and LOAD on the Port 1 and press corresponding button to complete the calibration successively, and then connect the THRU calibration kit between the two ports to perform the **Thru** calibration. After the calibration is completed, click **Finish** to exit the calibration interface, complete the calibration and save the calibration data.

After the calibration is complete and data is successfully saved, Corresponding compensation apply

button **Apply xxx Cali** will appear in the menu. Set on/off to control whether applies the calibration data or not.

Here's commands for calibration:

Command Format	:CORRection:COLLect:MEtHod:TYPE :CORRection:COLLect:MEtHod:TYPE?
Instruction	Sets/gets the cal type
Parameter Type	enumeration
Parameter Range	NONE OPEN SHORT 1PORT THRU ENHAnced E11 E21
Return	enumeration
Example	:CORRection:COLLect:MEtHod:TYPE SHORT

Command Format	:CORRection:COLLect:OPEN
Instruction	Collecting open step data
Example	:CORRection:COLLect:OPEN 1

Command Format	:CORRection:COLLect:SHORt
Instruction	Collecting short step data
Example	:CORRection:COLLect:SHORt 1

Command Format	:CORRection:COLLect:LOAD
Instruction	Collecting load step data
Example	:CORRection:COLLect:LOAD 1

Command Format	:CORRection:COLLect:THRU
Instruction	Collecting through step data
Example	:CORRection:COLLect:THRU 1

Command Format	:CORRection:COLLect:SAVE
Instruction	After the calibration procedure is completed, the calibration data is saved and applied
Example	:CORRection:COLLect:SAVE 1

Notice: Highest measurement accuracy is achieved when the frequency range or sweep settings remain the same during the measurement as when the calibration is performed. If these settings change after the calibration, SHA802X will interpolate the calibration so that it can still make VERY accurate measurement.

Interpolated Calibrations are only slightly less accurate than a calibration performed at the measurement settings. When a calibration that you performed is being interpolated, a questionmark will be added to the Cal annotation. For example: S11:C? is shown on the screen when the current Response or Mechanical cal is being interpolated. In order to achieve better measurement accuracy, it is recommended to recalibrate after changing the sweep-relevant settings.

5.9.4 Ecal

Ecal is an automatic calibration technology for VNA mode. Every ECal module contains electronic standards that are automatically switched into position during a measurement calibration. These electronic standards have been measured at the factory and the data stored within the memory of the ECal module. The analyzer uses this stored data, along with the measured data, to calculate the error terms for a measurement calibration. Ecal offers the following advantages compared to Mechanical calibration kit:

1. The calibration process is simple. The electronic calibrator only needs to be connected to the SHA802X once to complete the test items required by the dual-port calibration, without the need for multiple calibration connections.
2. A shorter time is required for calibration.
3. There are fewer uncertain factors in the calibration process, and the probability of electronic calibration being affected by misoperation is reduced because there is no need for multiple connection processes.

Ecal Calibration Steps:

1. Connect the USB port on the ECal module with the USB port of SHA802X via a USB cable. When the Ecal module indicator switches to “Ready”, it indicates the Ecal module has entered ideal working condition/temperature. After connecting the module, the type of module, frequency range, and connector type are automatically recognized.
2. Press **Cal->Ecal Info** to view all parameters of the characterization stored in the ECal module.

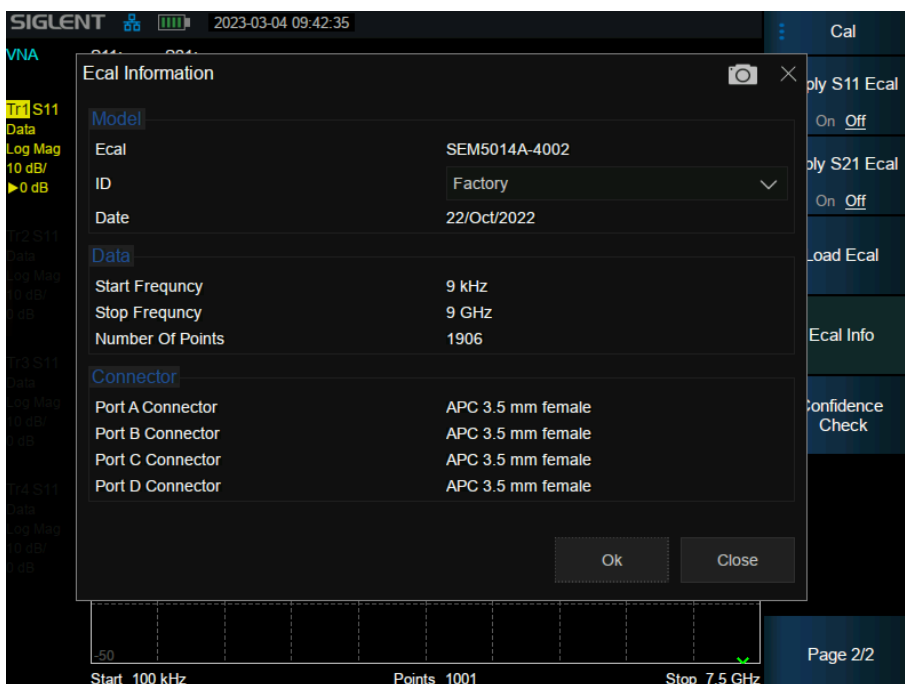

Figure 5-4 Ecal Information

In the figure above, you can see the date of production, frequency range, Number of Points and Connector type.

3. Click **Load Ecal** to start loading the data of selected Measurement characteristics to the SHA802X. If it is loaded before, then it will compare with saved data for consistency.
4. Click **Calibrate ▼**, Select **S11 ECal** or **S21 Ecal** to perform 1 port or two ports calibration respectively. Connect the calibration part and instrument port correctly according to the calibration prompt, click **Enter** to automatically calibrate then click **Finish** to save and apply the calibration data.

Command Format	:CORRection:COLLect:MEtHod:ECAL?
Instruction	Check whether the electronic calibration part is connected to the instrument
Return	Boolean , 0 1
Example	:CORR:COLL:MEtH:ECAL?

Command Format	:CORRection:COLLect:ECAL:MODULE :CORRection:COLLect:ECAL:MODULE?
Instruction	Set/query electronic calibration parts available electronic standard sample data
Parameter Type	enumeration
Parameter Range	Determined by electronic calibration part Return example:Factory User1
Return	enumeration
Example	:CORRection:COLLect:ECal:MODULE Factory

Command Format	:CORRection:COLLect:ECAL:LOAD :CORRection:COLLect:ECAL:CANCEL
Instruction	Execute/cancel the electronic calibration part to load the current selected electronic standard sample data
Example	:CORRection:COLLect:ECAL:LOAD

6 Modulation Analyzer Mode

MA mode includes digital modulation analysis (DMA) and analog modulation analysis (AMA). Press **Mode** key to select and add the expected mode to window management.

Press **Meas Setup** key to enter the corresponding measurement parameter configuration menu. According to the actual needs, select the required parameter configuration options, obtain the corresponding output waveform and observe the analysis results.

6.1 Digital Modulation Analysis (DMA)

Through digital signal analysis, a series of indicators such as error vector magnitude, magnitude error, and phase error can be obtained.

6.1.1 Settings

6.1.1.1 Average|Hold times

Average|Hold Times N, is the counter when the trace type is "average", "max hold" and "min hold". In a single measurement (Single), and any valid trace type is "average", "max hold" or "min hold", the sweep stops when the counter reaches N.

Larger (average|hold) times can reduce the influence of noise or other random signals, thereby highlighting stable signal characteristics in the signal.

Command format	[[:SENSe]:AVERage[:STATe] [:SENSe]:AVERage[:STATe]?
Instructions	Set the average measurement status Query the average measurement status
Parameter type	Boolean
Parameter Range	OFF ON 0 1
Return	Enumeration
Example	:AVERage ON

Command format	[[:SENSe]:AVERage:COUNT [:SENSe]:AVERage:COUNT?
Instructions	Set the average number of measurements Query the average number of measurements
Parameter type	Integer
Parameter Range	1 ~ 1000
Return	Integer
Example	:AVERage:COUNT 20

6.1.1.2 Statistic

Turn on the statistics function, the measurement results will display the maximum and minimum values of the statistics, turn off the statistics function, the measurement results will only display the

real-time measurement value. Statistics are disabled by default.

After performing a remeasurement, the statistical results will be cleared and the statistics will be restarted. If the averaging function is turned on, the average calculation of the measurement results will also be cleared and restarted.

Command format	[[:SENSe]:STATistic:STATe [:SENSe]:STATistic:STATe?
Instructions	Set digital demodulation measurement statistics status Query the statistical status of digital demodulation measurements
Parameter type	Boolean
Parameter Range	OFF ON 0 1
Return	Enumeration
Example	:STATistic:STATeON

Command format	:CALCulate:REStart
Instructions	Restart the statistical measurements
Example	:CALCulate:REStart

6.1.2 Demod

6.1.2.1 Demod Type & Format

Modulation types are as follows:

QAM modulation : 8QAM , 16QAM , 32QAM , 64QAM , 128QAM , 256QAM

PSK modulation : BPSK , QPSK , 8PSK , DBPSK , DQPSK , D8PSK , pi/4 DQPSK , pi/8 DQPSK , OQPSK

FSK modulation : 2FSK , 4FSK , 8FSK , MSK

ASK modulation : 2ASK

Command format	[[:SENSe]:DDEMod:MODulation [:SENSe]:DDEMod:MODulation?
Instructions	Sets the digital demodulation type Gets the digital demodulation type
Parameter type	Enumeration
Parameter Range	ASK2 MSK BPSK QPSK PSK8 DBPSK DQPSK DPSK8

	OQPSK PI4DQ PI8D8 QAM16 QAM32 QAM64 QAM128 QAM256 FSK2 FSK4 FSK8 FSK16
Return	Enumeration
Example	:DDEMod:MODulation FSK8

Command format	:READ:DDEMod?
Instructions	<p>Obtain digital demodulation results if demod type is ASK it will return: ASK err rms (% rms) ASK err peak (% pk) symbol position of ASK err peak carrier power carrier offset ASK depth</p> <p>If demod type is FSK it will return: 1.FSK err rms (% rms) 2.FSK err peak (% pk) 3.symbol position of FSK err peak 4. carrier power 5.carrier offset 6.FSK deviation</p> <p>If demod type is MSK,PSK,QAM it will return: 1. EVM rms (% rms) 2. EVM peak (% pk) 3. symbol position of EVM peak 4.magnitude error rms (% rms). 5. magnitude error peak (% pk) 6.symbol position of magnitude error peak 7.phase error rms (deg) 8.phase error peak (deg pk) 9.symbol position of phase error peak 10. frequency error (Hz) 11. IQ offset 12. SNR(MER) (dB) 13. quadrature error (deg) 14. gain imbalance (dB)</p>
Parameter type	None
Parameter Range	None
Return	String
Example	:READ:DDEMod?

6.1.2.2 Symbol Rate

Set the analyzer symbol rate (symbols per second) to match the system (signal).

The symbol rate setting is limited by the analyzer maximum bandwidth (BW_max).

Command format	:DDEMod[:FORMat]:SRATe :DDEMod[:FORMat]:SRATe?
Instructions	Sets the digital demodulation symbol rate Read digital demodulation symbol rate
Parameter type	Integer
Parameter Range	1000 ~ 25000000 The sign point is 4 , Maximum sign rate is 25e6 The sign point is 6 , Maximum sign rate is 25e6 The sign point is 8 , Maximum sign rate is 18.75e6 The sign point is 10 , Maximum sign rate is 15e6 The sign point is 12 , Maximum sign rate is 12.5e6 The sign point is 14 , Maximum sign rate is 10.714285e6 The sign point is 16 , Maximum sign rate is 9.375e6
Return	Integer
Example	:DDEMod:SRATe 2000

6.1.2.3 Points / Symbol

Sets the number of points for demodulating each symbol. The settable values are 2, 4, 8, 10, 12, 14, and 16.

Command format	[:SENSe]:DDEMod[:FORMat]:SYMBol:POINts [:SENSe]:DDEMod[:FORMat]:SYMBol:POINts?
Instructions	Sets digital demodulation symbol points Query digital demodulation symbol points
Parameter type	Discrete
Parameter Range	4 , 6 , 8 , 10 , 12 , 14 , 16
Return	Discrete
Example	DDEMod:SYMBol:POINts 14

6.1.2.4 Meas Interval

Set the length of digital demodulation analysis and display.

Command format	[:SENSe]:DDEMod[:FORMat]:RLENgth [:SENSe]:DDEMod[:FORMat]:RLENgth?
Instructions	Set digital demodulation measurement length Get digital demodulation measurement length
Parameter type	Integer
Parameter Range	16 ~ 4096
Return	Integer
Example	:DDEMod:RLENgth 200

6.1.2.5 Constellation Setting

Edit the symbol order of constellation positions.

6.1.3 Filter

6.1.3.1 Meas Filter

Enable and select Meas Filter.

Meas Filters that can be set include:

- Sqrt Nyquist
- Nyquist
- Gauss
- Half Sine

Command format	[[:SENSe]:DDEMod:FILTer[:MEASurement]] [:SENSe]:DDEMod:FILTer[:MEASurement]?
Instructions	Set up digital demodulation measurement filter Obtain digital demodulation measurement filter
Parameter type	Enumeration
Parameter Range	OFF RRCosine RECTangle GAUSSian HSIN
Return	0 1
Example	:DDEMod:FILTer HSIN

6.1.3.2 Ref Filter

Enable and select Ref Filter.

Ref Filters that can be set include:

- Sqrt Nyquist
- Nyquist
- Gauss
- Half Sine

Command format	[[:SENSe]:DDEMod:FILTer:REFerence] [:SENSe]:DDEMod:FILTer:REFerence?
Instructions	Sets the digital demodulation reference filter

	Query digital demodulation reference filter
Parameter type	Enumeration
Parameter Range	OFF RRCosine RECTangle GAUSSian HSIN
Return	Enumeration
Example	:DDEMod:FILTer:REFeRenceOFF

6.1.3.3 Filter Length

Sets the filter length used by the analyzer. This feature applies to MeasRef Filter and Ref Filter.

Command format	[[:SENSe]:DDEMod:FILTer:RLENgth [:SENSe]:DDEMod:FILTer:RLENgth?
Instructions	Set the filter length Gets the filter length
Parameter type	Float
Parameter Range	0~128
Return	Float
Example	:DDEMod:FILT:RLENgth 5

6.1.3.4 Alpha/BT

Sets the filter alpha characteristic value of the Sqrt Nyquist raised cosine and root raised cosine Nyquist filters used by the analyzer, or the BT value of the Gauss filter. This feature applies to Meas Ref Filter and Ref Filter.

Command format	[[:SENSe]:DDEMod:FILTer:ABT [:SENSe]:DDEMod:FILTer:ABT?
Instructions	Set the filter alpha Gets the filter alpha
Parameter type	Float
Parameter Range	0-1
Return	Float
Example	:DDEMod:FILT:ABT 0.5

6.1.4 Burst/sync Search

6.1.4.1 Search Length

Specifies the time range (length) to search for signals.

The search length must satisfy $\text{Search Length} \geq 1.2 * \text{Meas Interval} / \text{Symbol Rate}$. If modifying the Meas Interval or Symbol Rate causes the length not to meet the conditions, the analyzer will automatically calculate and match the minimum value.

Command format	[[:SENSE]:DDEMod:SYNC:SLENgth [:SENSE]:DDEMod:SYNC:SLENgth?
Instructions	Set the search length Gets the search length
Parameter type	Float
Parameter Range	1.28ms-4.672ms
Return	Float
Example	:DDEMod:SYNC:SLENgth 0.5ms

6.1.4.2 Burst Search

Burst search measures the burst power (pulses) in a signal and uses this to segment and isolate the signal for subsequent display and analysis. Using burst search, you can avoid the interference of invalid signals to the analysis process.

Command format	[[:SENSE]:DDEMod:SYNC:BURSt[:STATe] [:SENSE]:DDEMod:SYNC:BURSt[:STATe]?
Instructions	Set the burst search switch Query the burst search switch
Parameter type	Boolean
Parameter Range	OFF ON 0 1
Return	Enumeration
Example	:DDEMod:SYNC:BURS ON

6.1.4.3 Burst Search Threshold

Setting the thresholds for the rising and falling edges of the burst, in accordance with the peak power of the measured signal.

Command format	[[:SENSE]:DDEMod:SYNC:BURSt:THREshold [:SENSE]:DDEMod:SYNC:BURSt:THREshold?
Instructions	Set the burst search threshold Gets the burst search threshold
Parameter type	Float
Parameter Range	-200dBm~200dBm
Return	Float
Example	:DDEMod:SYNC:BURSt:THREshold -10

6.1.4.4 Burst Min Length

Setting the min Length for the rising and falling edges of the burst

Command format	[[:SENSE]:DDEMod:SYNC:BURSt:MINLength [:SENSE]:DDEMod:SYNC:BURSt:MINLength?
Instructions	Set the minimum burst length Gets the burst minimum length
Parameter type	Float
Parameter Range	10us~10ms

Return	Float
Example	:DDEMod:SYNC:BURSt:MINLength 0.5ms

6.1.4.5 Burst Min Gap

Setting the min gap for the rising and falling edges of the burst.

Represents the minimum distance (in "symbols") between adjacent bursts. The default value is 1 symbol in order to make sure that the burst search finds bursts that are very close to each other. However, in case the "capture buffer" does not contain very close bursts, it is recommended that you increase the value. This makes the burst search faster and also more robust for highly distorted signals.

Note that this parameter only influences the robustness of the burst search. It should not be used to explicitly exclude certain bursts from the measurement. For example, setting the minimum gap length to 100 "symbols" does not ensure that the burst search does not find bursts that have a very small gap.

Command format	[[:SENSe]:DDEMod:SYNC:BURSt:MINGap [:SENSe]:DDEMod:SYNC:BURSt:MINGap?
Instructions	Set the minimum burst interval Gets the minimum burst interval
Parameter type	Float
Parameter Range	10us~10ms
Return	Float
Example	:DDEMod:SYNC:BURSt:MINGap 0.5ms

6.1.4.6 Sync Search

Synchronization search is to search for synchronization codewords in the measured signal, and use this to segment and isolate the signal for subsequent display and analysis.

The synchronous codeword is a string of symbols (coding), so its length must be an integer multiple of the number of bits (number of bits) of each symbol.

Command format	[[:SENSe]:DDEMod:SYNC:SWORd[:STATe] [:SENSe]:DDEMod:SYNC:SWORd[:STATe]?
Instructions	Set the synchronization search switch Query the synchronization search switch
Parameter type	Boolean
Parameter Range	OFF ON 0 1
Return	Enumeration
Example	:DDEMod:SYNC:SWORd ON

6.1.4.7 Sync Offset

Specifies the time (in symbols) between the start of the measurement data and the start of the sync word. If positive, the sync word starts after the start of the measurement data. If negative, the sync word starts before the start of the measurement data.

Command format	[[:SENSE]:DDEMod:SYNC:SWORd:OFFSet [:SENSE]:DDEMod:SYNC:SWORd:OFFSet?
Instructions	Set the synchronous search offset Gets the synchronous search offset
Parameter type	Integer
Parameter Range	-10000~10000
Return	Integer
Example	:DDEMod:SYNC:SWORd:OFFSet 2

6.1.4.8 Sync Pattern

Edit and display sync codewords.

Command format	[[:SENSE]:DDEMod:SEGMent:BER:PATtern [:SENSE]:DDEMod:SEGMent:BER:PATtern?
Instructions	Set the BERT symbol Get BERT symbol
Parameter type	String
Parameter Range	0~320
Return	String
Example	:DDEMod:SEGMent:BER:PATtern "0011"

6.1.5 BERT

Bit error rate test function, that is, the analyzer uses the measurement result of the current demodulation analysis and the preset reference signal to compare by bit to obtain the bit error rate.

Reference signals that can be preset in the editing interface and can be saved to a user profile (.sta file) and loaded.

Command format	[[:SENSE]:DDEMod:SEGMent:BER:STATe [:SENSE]:DDEMod:SEGMent:BER:STATe?
Instructions	Setting the BERT switch Querying the BERT switch
Parameter type	Boolean
Parameter Range	OFF ON 0 1
Return	Boolean
Example	:DDEMod:SEGMent:BER:STATe ON

6.2 Analog Modulation Analysis (AMA)

Used for modulation analysis of analog signals, a series of indicators such as carrier power, modulation rate, THD can be obtained through analysis.

Analog modulation analysis includes AM, FM, PM modulation.

The modulation mode, IF bandwidth, and equivalent filter can be selected, and the data can be averaged.

Command format	:READ:ADEMod?
Instructions	Obtain the simulation demodulation result if demod type is AM it will return: carrier_power mod_rate am_depth sinad carrier_offset if demod type is FM it will return: carrier_power mod_rate fm_deviation sinad carrier_offset if demod type is PM it will return: carrier_power mod_rate pm radians sinad carrier_offset
Return	String
Example	:READ:ADEMod?

6.2.1 Demod Type

Analog modulation analysis includes AM, FM, PM modulation.

Command format	[:SENSe]:ADEMod:STYLE [:SENSe]:ADEMod:STYLE?
Instructions	Sets the analog demodulation type Get analog demodulation type (cannot be queried when not analog demodulation)
Parameter type	Enumeration
Parameter Range	AM: analog AM FM: analog frequency modulation PM: Analog phase modulation
Return	Enumeration : AM FM PM
Example	:ADEMod:STYLE AM

6.2.2 IFBW

The IFBW specifies the size of the IF bandwidth of the analyzed signal. If the setting is incorrect, it will affect the accuracy of the measurement results. The intermediate frequency bandwidth IFBW should be as small as possible, which can improve the signal-to-noise ratio of demodulation. IFBW can be set to: 1.2MHz, 960kHz, 600kHz, 480kHz, 300kHz, 240kHz, 120kHz, 96kHz and 60kHz.

For "AM" modulation analysis, the IFBW should be more than twice the modulation frequency; for "FM" modulation analysis, the IFBW should be more than twice the sum of the frequency offset plus the modulation frequency.

Command format	:CALCulate:IFBW:INDEX :CALCulate:IFBW:INDEX?
Instructions	Set the analog demodulation if bandwidth Obtain analog demodulation intermediate frequency bandwidth
Parameter type	Enumeration
Parameter Range	0-8
Return	0-8
Example	:CALCulate:IFBW:INDEX 5

6.2.3 EqLPF

The EqLPF specifies the equivalent low-pass filter bandwidth of the analyzed signal. If the setting is incorrect, it will affect the accuracy of the measurement results. EqLPF is an additional low-pass filter, which can be used to measure lower the modulation frequency of the modulation signal. The bandwidth of EqLPF is fractional times that of IFBW, and there are 6 gears to choose from, namely IFBW/6, IFBW/20, IFBW/60, IFBW/200, IFBW/600 and IFBW/2000.

The bandwidth of the EqLPF should be as small as possible, which can improve the signal-to-noise ratio of demodulation, but at the same time, it should be greater than or equal to the modulation frequency.

Command format	:CALCulate:EQLPf:INDEX :CALCulate:EQLPf:INDEX?
Instructions	Set up analog demodulation equalization filter Obtain analog demodulation equalization filter
Parameter type	Enumeration
Parameter Range	0-6
Return	0-6
Example	:CALCulate:EQLPf:INDEX 2

6.2.4 Average

Turn on or off the averaging option for measurement results, and you can set the number of items involved in the averaging calculation. When the averaging option is turned off, the "Average" column

of the measurement results becomes "Current". The larger the average number, the more stable the "average" value.

6.3 Freq

6.3.1 Freq & Span

In MA mode, only the center frequency can be configured.

Span cannot be set and is only used to show the equivalent channel bandwidth under the current configuration.

Command Format	<code>[:SENSe]:FREQUency:CENTer</code> <code>[:SENSe]:FREQUency:CENTer?</code>
Instruction	Sets the center frequency. Gets the center frequency.
Parameter Type	Float, unit: Hz, kHz, MHz, GHz
Parameter Range	0 Hz ~ 28 GHz
Return	Float, unit: Hz
Example	<code>[:SENSe]:FREQUency:CENTer 300 MHz</code>

6.3.2 CF Step

The frequency step is the length of using the direction keys to step when the center frequency is set. Pay attention to the following points during use:

Changing the value of the center frequency in fixed steps can achieve the purpose of switching the measurement channels quickly and continuously.

Command Format	<code>[:SENSe]:FREQUency:CENTer:STEP[:INCRement]</code> <code>[:SENSe]:FREQUency:CENTer:STEP[:INCRement]?</code>
Instruction	Sets frequency step. Gets frequency step.
Parameter Type	Float, unit: Hz, kHz, MHz, GHz
Parameter Range	1 Hz ~ 100 MHz
Return	Float, unit: Hz
Example	<code>[:SENSe]:FREQUency:CENTer:STEP[:INCRement] 20 MHz</code>

6.4 BW

6.4.1 EQBW

The MA mode does not support configuring the resolution bandwidth, and only displays the equivalent resolution bandwidth.

Command Format	[:SENSe]:BWIDth[:RESolution]?
Instruction	Querys equalization BW.
Parameter Type	None
Parameter Range	None
Return	Float, unit: Hz
Example	:BWIDth?

6.4.2 Window

The EQBW filter offers several different window functions that you can switch in real-time based on your measurement needs. The available window functions include Rectangular window, Hamming window, Hanning window, Flattop window, Blackman window. The Flattop window is used by default.

Command Format	[:SENSe]:DDEMod:FFT:WINDow:TYPE [:SENSe]:DDEMod:FFT:WINDow:TYPE?
Instruction	Sets window function. Gets window function.
Parameter Type	Enumeration RECTangular HAMMING : HANNing FLATtop BLACKman
Parameter Range	None
Return	Enumeration RECT HAMM HANN FLAT BLAC
Example	:DDEMod:FFT:WINDow:TYPE BLAC

6.5 Sweep

6.5.1 Measure/Sweep Control (Single/Continue/Restart)

Sweep/Measure:

Single/Continue controls the analyzer to perform a single sweep/measurement or continuous sweep/measurement.

Restart:

Restart the current sweep or measurement. In particular, in the continue mode, modifying some parameters will equivalently perform a restart sweep or measurement.

Command Format	:INITiat[:IMMEDIATE]
Instruction	Restart the current sweep. :INITiate:REStart and :INITiate:IMMEDIATE perform exactly the same function.
Parameter Type	None
Parameter Range	None
Return	None
Default	None
Menu	
Example	:INITiate:IMMEDIATE

Command Format	:INITiate:CONTinuous OFF ON 0 1 :INITiate:CONTinuous?
Instruction	Sets continuous sweep mode on-off. Gets continuous sweep mode state.
Parameter Type	Boolean
Parameter Range	OFF ON 0 1
Return	0 1
Example	:INITiate:CONTinuous OFF

Command Format	ABORt
Instruction	This command is used to stop the current measurement. It aborts the current measurement as quickly as possible, resets the sweep and trigger systems, and puts the measurement into an "idle" state. If the analyzer is set for Continuous measurement, it sets up the measurement and initiates a new data measurement sequence with a new data acquisition (sweep) taken once the trigger condition is met. If the analyzer is set for Single measurement, it remains in the "idle" state until an :INIT:IMM command is received.
Parameter Type	None
Parameter Range	None
Return	None
Default	None
Menu	None
Example	INIT;ABORt

6.6 Trigger

6.6.1 Trigger Source

The analyzer provides a variety of trigger sources to suit different triggering needs.

Free Run

Free trigger is the default use mode of the analyzer, at this time, the spectrum analyzer loops and continuously scans.

Video

Using the video trigger mode, a transient signal with a very short time can be captured. In this working mode, the signal will be triggered and displayed on the screen only when the rising or falling edge of a signal touches the Trigger Level.

External

External triggering provides more abundant triggering functions. If you want to realize periodic triggering and delayed triggering, you can choose the working mode of external triggering. In this mode, the trigger is controlled by the rising edge or falling edge of the external input signal, and a square wave signal of a certain frequency can be used for periodic triggering, and the trigger delay time can be adjusted by setting the trigger delay.

Period

When Periodic is selected, the analyzer uses the built-in period timer signal as a trigger. The trigger event is set by the period timer parameter, which is modified by the offset and periodic sync Src.

Use this trigger when there is a periodic signal but no reliable signal to trigger. You can synchronize the periodic signal to an external event (using the periodic sync Src) to get closer to a reliable trigger signal.

If no synchronization source is selected, then the internal timer will not be synchronized with any external timed events.

Command format	:TRIGger:SOURce :TRIGger:SOURce?
Instructions	sets the trigger source. gets the trigger source.
Parameter type	Enumeration
Parameter Range	"IMMEDIATE ", "VIDeo ", "EXTernal ", "FRAMe"
Return	"IMM", "VID", "EXT", "FRAMe"
Example	:TRIGger:SOURce VID

6.6.2 Trigger Level

Sets the amplitude level of the video trigger (only absolute levels are supported). A trigger occurs when the slope of the video signal crosses this level.

When the selected trigger source is video trigger, the trigger level will be displayed as an orange line, and the right end of the line will be displayed as:

Trig Line: xxxx dBm

Command format	:TRIGger: {type}:LEVel :TRIGger: {type}:LEVel?
Instructions	sets the trigger level. gets the trigger level. {type}: "VIDeo", "EXTernal"
Parameter type	Float
Parameter Range	-300~50dB
Return	Float
Example	:TRIGger:VIDeo:LEVel -20

6.6.3 Trigger Slope

Set the external trigger and video trigger trigger polarity. The options are rising edge trigger and falling edge trigger.

Command format	:TRIGger: {type}:SLOPe :TRIGger: {type}:SLOPe?
Instructions	sets the trigger edge. gets the trigger edge. {type}: "VIDeo ", "EXTernal "
Parameter type	Enumeration
Parameter Range	"POS", "NEG"
Return	"POS", "NEG"
Example	:TRIGger: EXTernal:SLOPe :TRIGger: VIDeo:SLOPe?

6.6.4 Trigger Delay

Set trigger delay, negative delay can be set.

The maximum duration of negative delay = 500M/(symbol rate*symbol points*8)

Command format	:TRIGger:{type}:DELay :TRIGger:{type}:DELay? :TRIGger:{type}:DELay:STATe :TRIGger:{type}:DELay:STATe?
Instructions	sets the trigger delay and state. gets the trigger delay and state. {type}: "VIDeo ", "EXTernal ", "FRAMe"
Parameter type	Float
Parameter Range	-500ms-500ms
Return	Float
Example	:TRIGger:EXTernal:DELay 5e-3 :TRIGger:FRAMe:DELay?

6.6.5 Zero Span Trigger Delay Compensation (External Trigger)

Under normal circumstances, after the trigger is generated, the displayed data and the data at the same time as the trigger are displayed, but because the processing time of the trigger path and the data path are different, the data displayed at the trigger time is the previous data. This does not affect the integrity of the data and will not cause data loss at the trigger point. However, in some cases, it is necessary to display the zero point of the screen coordinates as the input signal information of the trigger point. At this time, the function of zero-span trigger delay compensation is required.

6.6.6 Period(Period)

Set the trigger period.

Command format	:TRIGger:FRAMe:PERiod :TRIGger:FRAMe:PERiod?
Instructions	Set/Query Period Trigger period
Parameter type	Float
Parameter Range	100ns~10s
Return	Float
Example	:TRIGger:FRAMe:PERiod 1s

6.6.7 Offset Time(Period)

Adjusts the cumulative offset between the periodic trigger clock and the trigger event. The periodic trigger clock cannot be seen on the software, only the trigger event can be seen. So if you want to adjust the time of the trigger event, you can only adjust the offset between the periodic trigger clock and the trigger event, but the absolute value of the internal offset is unknown, and each modification to the offset is based on the previous Do accumulation.

Command format	:TRIGger:FRAMe:OFFSet :TRIGger:FRAMe:OFFSet?
Instructions	Set/Query Period Trigger period offset
Parameter type	Float
Parameter Range	0s~10s
Return	Float
Example	:TRIGger:FRAMe:OFFSet 1s

6.6.8 Reset Offset Display(Period)

The reset period triggers the time offset display. Modifying this parameter does not modify the absolute value of the internal offset.

Command format	:TRIGger:FRAME:OFFSet:DISPlay:RESet
Instructions	Reset Period trigger offset return to zero
Example	:TRIGger:FRAME:OFFSet:DISPlay:RESet

6.6.9 Sync Source(Period)

Set the sync source.

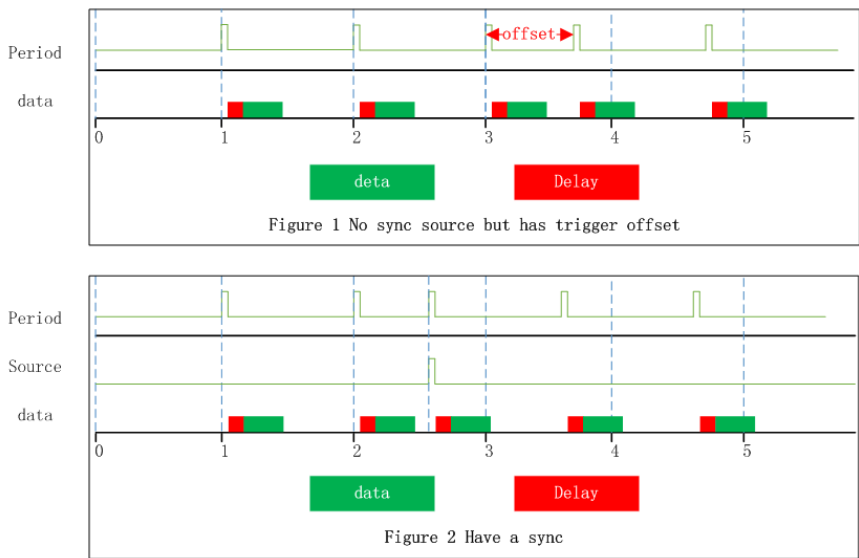

Figure 6–6-1 Sync Source trigger

Command format	:TRIGger:FRAME:SYNC :TRIGger:FRAME:SYNC?
Instructions	Set/Query the type of periodic synchronization
Parameter type	Enumeration
Parameter Range	"OFF", "EXT"
Return	"OFF", "EXT"
Example	:TRIGger:FRAME:SYNC EXT

6.6.10 Auto Trigger

Automatic triggering is an auxiliary triggering method used in non-Free run mode. When the user needs continuous triggering but the triggering conditions of the selected triggering type are not satisfied, automatic triggering can be used. After using the automatic trigger, the count starts after a measurement is completed. If the count does not reach the set value and the trigger condition of the selected trigger is satisfied, the count of the automatic trigger will be cleared and the count will be restarted after the next measurement. If the count reaches the set value and the trigger condition of the selected trigger is not met, the forced trigger condition is met, and then the measurement is performed according to the normal trigger process.

Command format	:TRIGger:ATRigger:STATe :TRIGger:ATRigger:STATe?
Instructions	Set or query the automatic trigger switch
Parameter type	Boolean
Parameter Range	0 1
Return	0 1
Example	:TRIGger:ATRigger:STATe 1

Command format	:TRIGger:ATRigger :TRIGger:ATRigger?
Instructions	Set or query the automatic trigger time
Parameter type	Float
Parameter Range	1us~100s
Return	Float
Example	:TRIGger:ATRigger 1s

6.6.11 Hold Off

In trigger inhibition, hold represents inhibition and off represents release. Trigger hold-off can be used for other trigger modes other than Free run mode. Intuitively, trigger hold-off can be understood as the strictening of trigger conditions, that is, the occurrence of a trigger must not only satisfy the trigger condition of the selected trigger, but also satisfy the additional conditions in trigger hold-off.

Normal

In normal mode, the count is performed before the trigger, and the next trigger can only be generated after the count meets the set requirements.

Above

For the rising edge of the video trigger (external trigger), it is required that after the trigger, the actual level is still higher than the trigger level (trigger threshold) for at least a specified time.

For the falling edge of video trigger (external trigger), it is required that the actual level is higher than the trigger level (trigger threshold) for a single accumulation time exceeding the specified time before triggering.

For the periodic trigger, the trigger moment is high level, the duration is a time period, and the other time is low level, which can be inferred according to other triggers.

Below

For the rising edge of video trigger (external trigger), it is required that the actual level is lower than the trigger level (trigger threshold) for a single accumulation time exceeding the specified time before triggering.

For the falling edge of the video trigger (external trigger), it is required that the actual level is still lower than the trigger level (trigger threshold) after triggering for at least a specified time.

The periodic trigger can be pushed in the same way.

Command format	:TRIGger:HOLDoff:STATe :TRIGger:HOLDoff:STATe?
Instructions	Set or query the trigger holdoff switch
Parameter type	Boolean
Parameter Range	0 1
Return	0 1
Example	:TRIGger:HOLDoff:STATe 1

Command format	:TRIGger:HOLDoff :TRIGger:HOLDoff?
Instructions	Set or query the trigger holdoff time
Parameter type	Float
Parameter Range	0~500ms
Return	Float
Example	:TRIGger:HOLDoff 0.01s

Command format	:TRIGger:HOLDoff:TYPE :TRIGger:HOLDoff:TYPE?
Instructions	Set or query the trigger holdoff type
Parameter type	Enumeration
Parameter Range	"NORMal", "ABOVe", "BELOW"
Return	"NORMal", "ABOVe", "BELOW"
Example	:TRIGger:HOLDoff:TYPE ABOVE

6.7 Ampt

6.7.1 Attenuator & RF Preamp

According to the amplitude of the input signal, the user can set the corresponding RF front-end attenuator and amplifier, the purpose of which is to avoid display distortion when inputting large signals and reduce noise when inputting small signals.

Command Format	[:SENSe]:POWer[:RF]:ATTenuation [:SENSe]:POWer[:RF]:ATTenuation?
Instruction	Sets the input attenuator. Gets the input attenuator.
Parameter Type	Integer, unit: dB
Parameter Range	0 dB ~ 51 dB
Return	Integer, unit: dB
Example	[:SENSe]:POWer[:RF]:ATTenuation 30 dB

Command Format	[:SENSe]:POWer[:RF]:ATTenuation:AUTO OFF ON 0 1 [:SENSe]:POWer[:RF]:ATTenuation:AUTO?
Instruction	Sets the input attenuator. Gets the input attenuator.
Parameter Type	Boolean
Parameter Range	OFF ON 0 1
Return	0 1
Example	[:SENSe]:POWer[:RF]:ATTenuation:AUTO ON

6.7.2 Ref Level & Scale

Displays and configures the reference and scale of the currently selected window. The unit is based on the unit of the trace data.

Auto Scale and Auto Scale All can be used to adjust the scale of the current and all windows adaptively to the waveform data.

Command Format	:TRACe1 2 3 4:Y[:SCALe]:RLEVel :TRACe1 2 3 4:Y[:SCALe]:RLEVel?
Instruction	This command sets the reference level for the Y-axis. Gets reference level. The command is valid if the measurement mode is ASK, FSK, MSK, PSK, QAM and the data format is not Syms/Errs.
Parameter Type	Float
Parameter Range	If the display type is Log Mag: -1000 ~ 1000 If the display type is Lin Mag: -1000 ~ 1000 If the display type is Real: -1000 ~ 1000 If the display type is Imag: -1000 ~ 1000 If the display type is I-Q: -1000 ~ 1000 If the display type is Constellation: -1000 ~ 1000 If the display type is I-Eye: -1000 ~ 1000 If the display type is Q-Eye: -1000 ~ 1000 If the display type is Wrap Phase: -1000 ~ 1000 If the display type is Unwrap Phase: -1000 ~ 1000 If the display type is Trellis-Eye: -1e5 ~ 1e9
Return	Float
Default	
Example	:TRACe4:Y:RLEVel 2

Command Format	:TRACe1 2 3 4:Y[:SCALe]:PDIVision :TRACe1 2 3 4:Y[:SCALe]:PDIVision?
Instruction	This command sets the per-division display scaling for the y-axis. Gets Scale/Div when scale type. The command is valid if the measurement mode is ASK, FSK, MSK, PSK, QAM and the data format is not Syms/Errs.
Parameter Type	Float
Parameter Range	
Return	Float
Example	:TRACe4:Y:PDIVision 2

Command Format	:TRACe1 2 3 4[:Y]:AUToscale
Instruction	Sets auto scale.
Parameter Type	None
Parameter Range	None
Return	None
Example	:TRACe2:AUToscale

6.8 Trace

6.8.1 Select Trace

Select the current trace you want to select. After a trace is selected, parameters such as the reference level of the trace can be adjusted. You can also touch the screen and click the window where the trace is located to select the trace.

After the trace is selected, the mark ">" is displayed to the left of the trace mark.

Command Format	:CALCulate:PARAmeter:COUNt :CALCulate:PARAmeter:COUNt?
Instruction	Sets trace number. Gets trace number.
Parameter Type	Integer
Parameter Range	1 ~ 4
Return	Integer
Example	:CALCulate:PARAmeter:COUNt 4

6.8.2 Layout

Select the layout of the screen windows. The layout types are as follows:

- Single
- Stacked 2
- Grid 1,2
- Grid 2x2

Command Format	:DISPlay:LAYout
Instruction	Sets trace layout on screen. Currently, one row, two columns are not supported (1, 2)
Parameter Type	Integer (rows, columns)
Parameter Range	rows 1 ~ 2 columns 1 ~ 2
Return	
Example	:DISPlay:LAYout 2,2

6.8.3 Trace Display and Layout (DMA)

Window layout:

You can choose to display 1 to 4 windows, and each window can specify the trace data type.

Symbol table:

Displays the demodulated digital symbol code, which can be expressed in binary or hexadecimal.

6.8.4 Trace Display and Layout (AMA)

Display up to 3 windows, each window displays different traces, respectively:

Time domain waveform;

Frequency domain waveform;

Demodulation result parameters.

6.8.5 Select Trace

Select the trace in order to set the corresponding trace parameters. You can also select the trace by clicking on the trace mark displayed in the left status bar of the screen.

6.8.6 Num of Traces

Set the upper limit of displayed trace numbers. Up to four traces can be displayed simultaneously in the screen window.

6.8.7 Data

Select the displayed data of the trace.

Command Format	:TRACe[1] 2 3 4:DATA:NAME :TRACe[1] 2 3 4:DATA:NAME?
Instruction	Sets trace format. Gets trace format.
Parameter Type	Enumeration
Parameter Range	TIME: time SPECTrum: spectrum MTIME: IQ meas time MSPECTrum: IQ meas spectrum (FFT of IQ Meas Time.) RTIME: IQ Reference time (Reconstructed ideal time waveform to compare IQ Meas Time against)

	RSPEctrum: IQ Reference spectrum (FFT of IQ Reference time.)
	MERRor: IQ Mag Err (Difference in length of the IQ Meas Time vector and IQ Ref Time vector at each point in time.)
	PERRor: IQ Phase Err (Difference in phase of the IQ Meas Time vector and IQ Ref Time vector at each point in time.)
	EVTime: Error Time (Vector difference between IQ Meas Time and IQ Ref Time at each point in time.)
	EVSPectrum: Error Vector Spec
	SYMSerrs: Syms/Errs
	RAWtime: Raw data
Return	Enumeration
Example	:TRACe:DATA:NAME SYMS

6.8.8 Format

Select the displayed format of the trace.

Command Format	:TRACe[1][2][3][4]:FORMat[:Y] :TRACe[1][2][3][4]:FORMat[:Y]?
Instruction	Sets trace format Gets trace format
Parameter Type	Enumeration
Parameter Range	MLOG: Log Mag MLINear: Lin Mag REAL: Real IMAGinary: Imag IQ: I-Q CONStIn: Constellation IEYE: I-Eye QEYE: Q-Eye WPHase: Wrap Phase UWPHase: Unwrap Phase TRELlis: Trellis-Eye
Return	MLOG MLIN REAL IMAG IQ CONS IEYE QEYE WPHA UWPH TREL
Example	:TRACe:FORMat MLIN

6.8.9 Eye Length

Set the length of the Eye diagram.

Command Format	:TRACe:DEMod:EYE:LENGth :TRACe:DEMod:EYE:LENGth?
-----------------------	---

Instruction	Sets eye length. Gets eye length.
Parameter Type	Integer
Parameter Range	2 ~ 40
Return	Integer
Example	:TRACe:DEMod:EYE:LENGth 4

6.8.10 Symbol Table

Display the demodulation digital symbols (binary or hex).

Command Format	:TRACe:DEMod:TABLE:FORMat :TRACe:DEMod:TABLE:FORMat?
Instruction	Displays format of Symbol Table data.
Parameter Type	Enumeration
Parameter Range	BINary HEXadecimal
Return	Enumeration BIN HEX
Example	:TRACe:DEMod:TABLE:FORMat HEX

6.9 Marker

6.9.1 Select Marker & Select Trace

To operate a marker, it must first be selected as the marker for the current operation. When there are multiple active marker, the marker currently operating in the waveform area will be displayed at the front, while other marker will be hollowed out (filled in black). At this time, the upper right corner of the waveform area will also display the reading of the current marker. To query the readings of all active marker, open the marker table ([Marker Settings]:[Marker Table]).

A marker can only be associated with one trace. When adding a marker, if it is not manually selected, the marker will be associated with the currently activated trace by default (refer to the trace setting).

6.9.2 Marker Type

Marker supports 2 types : normal,delta,off. Depending on the type of marker, the reading and position of the marker are also different when the trace is refreshed:

- normal: The marker is attached to a trace point, the vertical position of the marker is refreshed synchronously with the trace refresh, and the reading is the reading of the trace point.
- delta : delta marker use a pair of marker to identify the frequency (time) and amplitude difference between two trace points.

After selecting "delta", a pair of marker will appear on the trace: a fixed reference marker (marked by a marker number and "+", such as "1+") and a difference marker (marked by a relative marker

number and a symbol "Δ") identifier, such as "1Δ2"). At this time, the reading in the upper right corner of the waveform area also displays the frequency (or time) difference and amplitude difference between the difference marker and the reference marker, respectively.

After the marker selects "delta", the original marker will become the difference measurement marker. If it is not specified, the marker with the current marker number increasing by default will become the reference "fixed" marker.

The delta marker is in the "relative" state, similar to the "normal" marker, and its X-axis position can be changed; the reference marker is in the "fixed" state by default (the X-axis and Y-axis positions are fixed), but can be changed to "normal" by changing state and the X axis can be adjusted.

- off : close marker.

Notice:

When opening a marker or modifying parameters, if the marker has never been opened or the marker position exceeds the current span range, the horizontal position of the marker will be the center frequency, that is, the center of the waveform area.

A marker's relative marker has one and only one and cannot be itself. A marker can be the relative marker of multiple marker at the same time.

When closing a marker, the marker type of other relative markre that it is a relative marker will automatically change to normal.

Command Format	:TRACe[1] 2 3 4:MARKer[1] 2 3 4:ENABLE OFF ON 0 1 :TRACe[1] 2 3 4:MARKer[1] 2 3 4:ENABLE?
Instruction	Sets marker state. Gets marker state.
Parameter Type	Boolean
Parameter Range	OFF ON 0 1
Return	0 1
Example	:TRACe1:MARKer1:ENABle ON

Command Format	:TRACe[1] 2 3 4:MARKer[1] 2 3 4:TYPE POSition DELTA OFF :TRACe[1] 2 3 4:MARKer[1] 2 3 4:TYPE?
Instruction	Sets marker mode. Gets marker mode.
Parameter Type	Enumeration
Parameter Range	POSition DELTA OFF
Return	Enumeration: POS DELT OFF
Example	:TRACe:MARKer:TYPE POSition

6.9.3 Marker X

Set the horizontal position parameter of the current marker.

When the [marker Type] of the current marker is [Off], the marker frequency/marker time cannot be set.

Command Format	:TRACe[1] 2 3 4:MARKer[1] 2 3 4:X :TRACe[1] 2 3 4:MARKer[1] 2 3 4:X?
Instruction	Sets marker X value. Gets marker X value. This command only works when marker is not off.
Parameter Type	Float
Parameter Range	
Return	Float
Example	:TRACe:MARKer:X 200 :TRACe:MARKer:X?

Command Format	:TRACe[1] 2 3 4:MARKer[1] 2 3 4:Y?
Instruction	Gets marker Y value.
Parameter Type	None
Parameter Range	None
Return	Float
Example	:TRACe:MARKer:Y?

6.9.4 Reset Delta

Pressing this control is exactly the same as pressing the “Delta” selection on the Marker Mode radio button. The selected marker becomes a Delta Marker . If the selected marker is already a Delta marker, the reference marker is moved to the current position of the selected marker, thus resetting the Delta to zero.

6.9.5 Relative To

“Relative to” is used to measure the delta values of X (Frequency or Time) and Y (Amplitude) between two markers which can mark on different traces.

After the marker selects “Delta”, the original marker will become the delta measurement marker, and the related marker of the incrementing sequence number will become the reference “fixed” marker

Command Format	:TRACe[1] 2 3 4:MARKer[1] 2 3 4:REFerence :TRACe[1] 2 3 4:MARKer[1] 2 3 4:REFerence?
Instruction	Sets reference marker. Gets reference marker. Cannot set the current marker to the reference marker.
Parameter Type	Integer

Parameter Range	1 ~ 4
Return	1 ~ 4
Example	:TRACe:MARKer:REfERENCE 3

6.9.6 Marker Couple

When this function is On, moving any marker causes an equal X Axis movement of every other marker which is Off.

Command Format	:CALCulate[:SElected]:MARKer:COUPle OFF ON 0 1 :CALCulate[:SElected]:MARKer:COUPle?
Instruction	Sets marker couple state. Gets marker couple state.
Parameter Type	Boolean
Parameter Range	OFF ON 0 1
Return	0 1
Example	:CALCulate:MARKer:COUPle ON

7 Input and Output

7.1 Freq Ref Input

Frequency Reference Source include inside reference source, external reference source and auto-selection reference source. When external reference source is not connected, the button of external reference is not available. Default auto-selection reference source.

Command Format	[[:SENSe]:ROSCillator:SOURce:TYPE [:SENSe]:ROSCillator:SOURce:TYPE?
Illustration	Set Reference Source
Parameter Type	Enumeration
Parameter Range	INTE EXT SENS
example	:ROSCillator:SOURce:TYPE INTE :ROSCillator:SOURce:TYPE EXT :ROSCillator:SOURce:TYPE SENS

7.2 Input Z Correction

Input Impedance include 50 Ohm and 75 Ohm, default 50 Ohm. A adaptor of 75 Ohm to 50 Ohm is required, when the input impedance select 75 Ohm.

The selection of input impedance will influence calculation result only. That influence include voltage and electric current (dBmV, dBuV, dBuA, V, A), but power.

Command Format	[[:SENSe]:CORRection:IMPedance[:INPut][:MAGNitude] [:SENSe]:CORRection:IMPedance[:INPut][:MAGNitude]?
Illustration	Set Input Impedance
Parameter Type	Enumeration
Parameter range	OHM50 OHM75
example	:CORRection:IMPedance OHM50 :CORRection:IMPedance OHM75

7.3 GPS

7.3.1 GPS Switch

When GPS is on, enable GPS to start star search, and display "GPS Display information" below the system status bar, see area 2 in the following figure. Display "GPS Satellite Lock Icon" in the system status bar, see area 1 below.

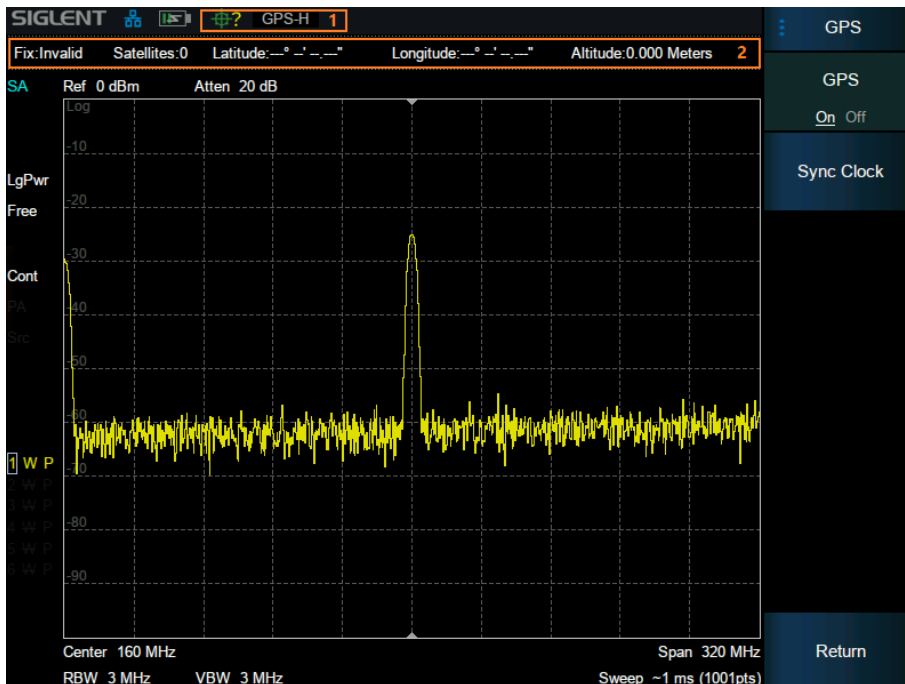

Figure 7-1 GPS on

GPS display information:

Fix information: Invalid void, GNSS Global navigation satellite system, DGPS Differential global positioning system, Estimated unknown system

Satellites information : Number of satellites.

Latitude information : longitude

Longitude information : latitude

Altitude information : altitude

Command Format	:SYSTEM:GPS :SYSTEM:GPS?
Instructions	Set GPS switch Acquire GPS switch
Parameter type	Boolean
Parameter Range	0 1
Return	Boolean
Example	:SYSTEM:GPS 1

Command Format	:SYSTem:GPS:INFO?
Instructions	Obtain GPS information
Return	string
Example	:SYSTem:GPS:INFO?

7.3.2 Clock Synchronization Button

When GPS is turned on and can be clicked, the button is immediately enforced once GPS taming. If the GPS taming succeeds, a message is displayed indicating that the GPS taming succeeds. Otherwise, a message indicating that the GPS taming fails. The prerequisite for tame execution is that Satellites are successfully locked (Satellites are not 0).

Command Format	:SYSTem:CLOCK:SERVo
Instructions	Perform a GPS tame
Example	:SYSTem:CLOCK:SERVo

7.4 BIAS

7.4.1 Bias switch

After the Bias switch is turned on, the Bias out port of the spectrometer outputs a voltage.

Command Format	:SYSTem:BIAS :SYSTem:BIAS?
Instructions	Set Bias switch Acquisition Bias switch
Parameter type	Boolean
Parameter Range	0 1
Return	Boolean
Example	:SYSTem: Bias1

7.4.2 Bias voltage

Bias voltage setting

Command Format	:SYSTem:BIAS:VALUe :SYSTem:BIAS:VALUe?
Instructions	Bias voltage setting Gain Bias voltage
Parameter type	Float
Parameter Range	12V~32V
Return	Float
Example	:SYSTem:BIAS:VALUe 20

8 System Settings

8.1 System

8.1.1 About

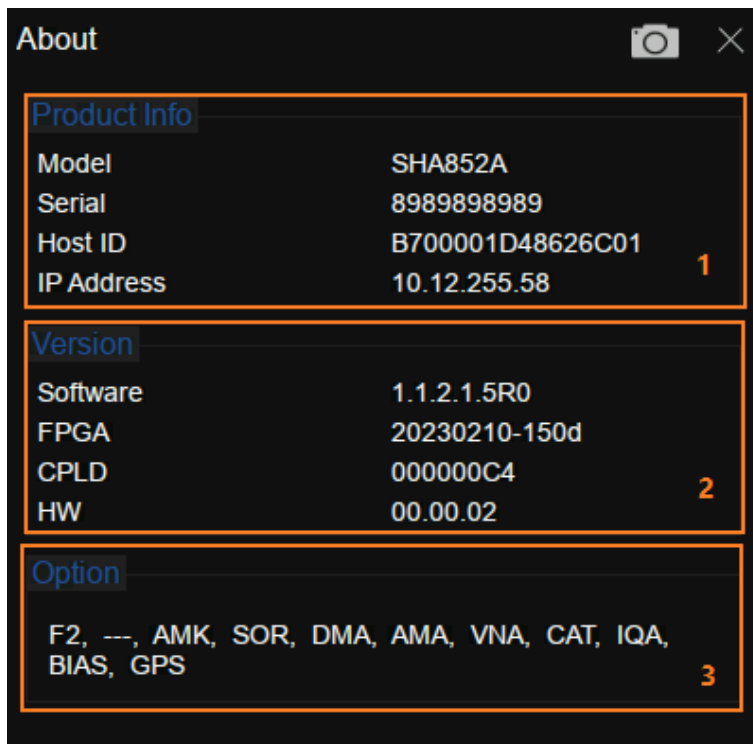

Figure 8–1 about

Area 1 Displays product information, including product name, serial number, Host ID, and IP address.

Area 2 Displays firmware information including software version, FPGA version, CPLD version, and hardware version.

Area 3 displays information about installed options.

Command format	:SYSTem:CONFigure:SYSTem?
Instructions	Query device system information
Return	String
Example	:SYSTem:CONFigure:SYSTem?

8.1.2 Hardware



Figure 8–2 Hardware

Area 1 displays the current operating status of the analyzer, including the RF board temperature, CPU temperature, and fan speed.

Area 2 displays automatic alignment (temperature drift compensation) information, including calibration status, time of last calibration, temperature, and temperature difference.

Area 3 shows information about installed options.

8.1.3 Log Record

Display system alarms and warnings.

8.1.4 Language

The analyzer supports a multi-language menu, Chinese and English built-in help and popup messages.

Press this key to select the desired display language.

Command format	:SYSTem:LANGUage CHINESE ENGLISH :SYSTem:LANGUage?
Instructions	Setting languages Acquire languages
Parameter type	Enumeration
Parameter Range	CHINESE ENGLISH
Return	Enumeration: CHINESE ENGLISH
Example	:SYSTem:LANGUage CHINESE :SYSTem:LANGUage?

8.1.5 Connect Setting

8.1.5.1 Network Configuration

Display the MAC address.

Dynamically obtain network IP information (DHCP) or manually set IP address, subnet mask, and gateway parameters.

Command format	:SYSTem:COMMunicate:LAN:TYPE :SYSTem:COMMunicate:LAN:TYPE?
Instructions	Set/Obtain the DHCP switch
Parameter type	Boolean
Parameter Range	0 1
Return	0 1
Example	:SYSTem:COMMunicate:LAN:TYPE 1 :SYSTem:COMMunicate:LAN:TYPE?

Command format	:SYSTem:COMMunicate:LAN:IPADdress {"xxx.xxx.xxx.xxx"} :SYSTem:COMMunicate:LAN:IPADdress?
Instructions	Setting an IP Address Obtaining an IP Address
Parameter type	String
Parameter Range	The IP address Settings must comply with specifications (0-255:0-255:0-255:0-255)
Return	IP address string
Example	:SYSTem:COMMunicate:LAN:IPADdress "192.168.1.12" :SYSTem:COMMunicate:LAN:IPADdress?

Command format	:SYSTem:COMMunicate:LAN:GATeway {"xxx.xxx.xxx.xxx"} :SYSTem:COMMunicate:LAN:GATeway?
Instructions	Set the gateway Access gateway
Parameter type	String
Parameter Range	The IP address must comply with the nic specifications (0-255:0-255:0-255:0-255)
Return	Gateway string

Example	:SYSTem:COMMunicate:LAN:GATeway "192.168.1.1" :SYSTem:COMMunicate:LAN:GATeway?
Command format	:SYSTem:COMMunicate:LAN:SMASk {"xxx.xxx.xxx.xxx"} :SYSTem:COMMunicate:LAN:SMASk?
Instructions	Set the subnet mask according to your computer network Settings Obtain the subnet mask
Parameter type	String
Parameter Range	The IP address must comply with the nic specifications (0-255:0-255:0-255:0-255)
Return	string
Example	:SYSTem:COMMunicate:LAN:SMASk "255.255.255.0" :SYSTem:COMMunicate:LAN:SMASk?

8.1.5.2 Web services

Analyzer supports web VNC remote access. The analyzer will display the content of the remote projection to the web page, at the same time support mouse and keyboard remote input parameters.

VNC reset can be set to View only mode. In this case, the input on the web page is invalid.

- When you log in to the VNC, enter the same password as the preset one.
- To change the port or viewing mode, you need to restart VNC.

Command format	:SYSTem:WEB:PSW :SYSTem:WEB:PSW?
Instructions	Set web password Get web password
Parameter type	String
Return	Stringxxxxxx
Example	:SYSTem:WEB:PSW "123456"

8.1.5.3 GPIB

Set the GPIB port number. USB Host port on the front panel provides USB-GPIB connection. Use an original board card.

Command format	:SYSTem:COMMunicate:GPIB:ADDRess {password} :SYSTem:COMMunicate:GPIB:ADDRess?
Instructions	Set the GPIB Get the GPIB
Parameter type	Integer
Return	GPIB address (integer)
Example	:SYSTem:COMMunicate:GPIB:ADDRess 25

8.1.6 Date and Time

Switch the time and date display status in the upper right corner of the screen.

Modify the system time display format, including YMD, MDY, and Dmy.

Command format	:SYSTem:TIME :SYSTem:TIME?
Instructions	Setting the System Time Obtaining system time
Parameter type	String
Parameter Range	Hours (0~23), minutes (0~59), seconds (0~59)
Return	Stringxxxxxx
Example	:SYSTem:TIME 182559 :SYSTem:TIME?

Command format	:SYSTem:DATE :SYSTem:DATE?
Instructions	Set the system date Get system date
Parameter type	String
Parameter Range	Year (four lengths), month (1~12), day (1~31)
Return	String:xxxxxxx
Example	:SYSTem:DATE 20220101 :SYSTem:DATE?

8.1.7 Option

Load the option by loading the purchased.lic option file

Command format	:SYSTem:LKEY {"option"},{"license key"}
Instructions	Loading the specified option with the registration code, Restart to take effect
Parameter type	Enumeration , String
Parameter Range	"option" : RTSA DMA AMA AMK RT40 "license key" : DING YANG technology to provide authorization code, 16 - bit string
Example	:SYSTem:LKEY "RESA","fjbdajffnkImgwno"

8.1.8 Upgrade

Select from memory. The ADS file upgrades the firmware. After the firmware is upgraded, the machine will restart

8.2 Reset

8.2.1 Preset

Perform a reset operation based on the reset type currently set.

Command format	:SYSTem:PRESet
Note	Reset the device parameters based on the reset type
Example	:SYSTem:PRESet

8.2.2 Preset Type

Perform the reset operation based on the current reset type. Select a configuration type for the spectrum analyzer to reset and load. Reset Settings Preset types include default, last time, and User.

- Default: Reset the default loading parameters
- Last time: reset to the state before the user's last software shutdown.
- User: Resets and loads the configuration file specified by the user. This file can be obtained by saving the user Settings.

Command format	:SYSTem:PRESet:TYPE DFT LAST USER :SYSTem:PRESet:TYPE?
Note	Set the reset configuration type Gets the reset configuration type
Parameter	type enumeration
Parameter Range	DFT : default LAST : last USER :user
The return value	enumeration : DFT LAST USER
The default value	DFT
Example	:SYSTem:PRESet:TYPE DFT

8.2.3 Save User Config

Saves the current system state as user-defined Settings to internal non-volatile storage.

Command format	:SYSTem:PRESet:USER#:SAVE :SYSTem:PRESet:USER#:LOAD
LOAD	Save the user configuratio Loading user Configuration
Example	:SYSTem:PRESet:USER2:SAVE :SYSTem:PRESet:USER2:LOAD

8.2.4 Power On

Select the configuration to be loaded during power-on. Default configuration, last configuration, and User configuration are available

Command format	:SYSTem:PON:TYPE DFT LAST USER :SYSTem:PON:TYPE?
Note	Set the startup load configuration type Get the startup load configuration type
Parameter type	enumeration
Parameter Range	DFT : Default LAST : last USER : user
The return value	enumeration : DFT LAST USER
Default Values	DFT
Example	SYSTem:PON:TYPE DFT

8.2.5 Factory Reset

When Factory Reset is selected, the device will recall the initial config.

Command format	:SYSTem:FDEFault
Note	Restore the factory default Settings
Parameter type	None
Parameter Range	None
The return value	None
Default Values	None
Example	:SYSTem:FDEFault

8.2.6 Reset&Clear

Clear the current Settings and restore the default Settings.

Command format	:SYSTem:CLEAr
Note	Clear system Settings/files
Parameter type	None
Parameter Range	None
The return value	None
Default Values	None
Example	:SYSTem:FDEFault

8.3 Alignments

The alignment function is used to calibrate errors caused by temperature drift.

Automatic alignment:

After automatic alignment is turned on, the analyzer determines and triggers temperature error calibration logic based on temperature changes.

Calibrate now:

Perform a temperature error calibration immediately.

Command format	:CALibration:STATe 0 1 :CALibration:STATe?
Note	Sets/gets the automatic calibration switch
Parameter type	Boole
Parameter Range	0 1
The return value	0 1
Default Values	0
Example	:CALibration:STATe 0

Command format	:CALibration
Note	Perform a calibration immediately
Parameter type	None
Parameter Range	None
The return value	None
Example	:CALibration

8.4 File

Activate the analyzer file operation dialog box to perform file-related operations. Include: File Browser, File Browser, and Recall File.

Command format	:MMEemory:STORe STA TRC COR CSV LIM JPG BMP PNG, "{file}"
Note	Different modes support different types of file formats
Parameter type	characterstring
Example	:MMEemory:STORe STA, "ABC.sta"

Command format	:MMEemory:LOAD STA TRC COR LIM, "{file}"
Note	Read the file
Parameter type	characterstring
Example	:MMEemory:LOAD STA, "ABC.sta" ("File name needs to be added")

Command format	:MMEemory:DELeTe "{file}"
Note	Delete files or folders
Parameter type	character string
Example	:MMEemory:DELeTe "ABC.sta"

8.5 Display

Set screen brightness.

Set grid brightness in waveform area.

Set buzzer state

Set buzzer volume

Command format	:DISPlay:WINDow:TRACe:GRATICule:GRID:BRIGhtness :DISPlay:WINDow:TRACe:GRATICule:GRID:BRIGhtness?
Instructions	Set the grid brightness of the waveform area Get waveform area grid brightness
Parameter type	Integer
Parameter Range	0~100
Return	Integer
Example	:DISPlay:WINDow:TRACe:GRATICule:GRID:BRIGhtness 50

Command format	:DISPlay:WINDow:TRACe:SCREen:BRIGhtness :DISPlay:WINDow:TRACe:SCREen:BRIGhtness?
Instructions	Set screen Brightness Get screen brightness
Parameter type	Integer
Parameter Range	0~100
Return	Integer
Example	:DISPlay:WINDow:TRACe:SCREen:BRIGhtness 50

Command format	:DISPlay:WINDow:BEEP:VOLUme :DISPlay:WINDow:BEEP:VOLUme?
Instructions	Set the volume of the buzzer Gets the buzzer volume
Parameter type	Integer
Parameter Range	0~100
Return	Integer
Example	:DISPlay:WINDow:BEEP:VOLUme 50

Command format	:DISPlay:WINDow:BEEP:STATe :DISPlay:WINDow:BEEP:STATe?
Instructions	Set the buzzer switch Obtain the buzzer switch
Parameter type	Boolean
Parameter Range	0/1
Return	0/1
Example	:DISPlay:WINDow:BEEP:STATe 1

8.6 Power

This menu provides shutdown and restart operation buttons.

Analysis Provides energy saving options. You can set the analyzer to automatically turn off the display if no operation is performed within a specified period of time.

When the power-on and power-on function is turned on, the analyzer is powered on and can be turned off.

Command format	:SYSTem:POWer:OFF
Instructions	Close the device
Example	:SYSTem:POWer:OFF

Command format	:SYSTem:POWer:OFF
Instructions	Restart the device (some machines may not support restart and need to be manually started after shutdown)
Example	:SYSTem:REStart

8.7 Self Test

8.7.1 Screen Test

Test whether the screen has any pixel defects by displaying five colors: White, Red, Green, Blue and Black. Press 'Preset' key to switch the screen color and press '←' key to exit the test.

8.7.2 Keyboard Test

Enter the keyboard test interface. Press the function keys at the front panel one-by-one and observe whether the corresponding key is checked. If not, an error may have occurred in that key. To exit the test, press '←' four times.

8.7.3 LCD Test

If the keys at the front panel are transparent, when the key is pressed, the corresponding backlight will turn on when testing it.

8.7.4 Touch Test

Test whether the touch screen has any defects by touching the test button at specific spots on screen.

9 Remote Control

The analyzer features LAN, USB Device, and GPIB_USB module interfaces. By using a computer with these interfaces, and a suitable programming language (and/or NI-VISA software), users can remotely control the analyzer based on SCPI (Standard Commands for Programmable Instruments) command set, LabView and IVI (Interchangeable Virtual Instrument), to interoperate with other programmable instruments.

This chapter introduces how to build communication between the analyzer and a controller computer with these interfaces.

9.1 Remotely Operating the Analyzer

The analyzer provides both the USB and LAN connection which allows you to set up a remote operation environment with a controller computer. A controller computer could be a personal computer (PC) or a minicomputer. Some intelligent instruments also function as controllers.

9.1.1 USB Device port

Refer to the following steps to finish the connection via USB-Device:

- 1 Install NI-VISA on your PC for USB-TMC driver.
- 2 Connect the analyzer USB Device port to a PC with a USB A-B cable.
- 3 Switch on the analyzer.

The analyzer will be detected automatically as a new USB hardware.

9.1.2 LAN port

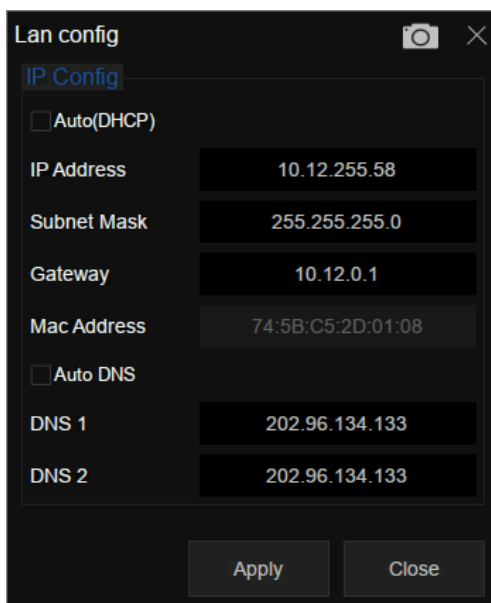

Figure 9–1 LAN config

Refer to the following steps to finish the connection via LAN:

- 1 Install NI-VISA on your PC for VXI driver. Or without NI-VISA, using socket or telnet in your PC's Operating System.
- 2 Connect the analyzer to PC or the local area network with a LAN cable.
- 3 Switch on the analyzer.
- 4 Press button on the front panel **System** → **Interface** → **LAN** to enter the LAN Config function menu.
- 5 Select the IP Config between Static and DHCP.
 - DHCP: the DHCP server in the current network will assign the network parameters automatically (IP address, subnet mask, gate way) for the analyzer.
 - Static: you can set the IP address, subnet mask, gate way manually. Press Apply.

The analyzer will be detected automatically or manually as a new LAN point.

9.1.3 GPIB-USB Host port

Refer to the following steps to finish the connection via USB:

- 1 Install NI-VISA on your PC for GPIB driver.
- 2 Connect the analyzer USB Host port to a PC's GPIB card port, with SIGLENT USB-GPIB adaptor.
- 3 Switch on the analyzer



Figure 9-2 SIGLENT USB-GPIB Adaptor

- 4 Press button on the front panel **System** → **Interface** → **GPIB** to enter the GPIB number.

The analyzer will be detected automatically as a new GPIB point.

9.2 Build Communication

9.2.1 VISA

NI-VISA includes a Run-Time Engine version and a Full version. The Run-Time Engine version provides NI device drivers such as USB-TMC, VXI, GPIB, etc. The full version includes the Run-Time Engine and a software tool named NI MAX that provides a user interface to control the device.

You can get NI-VISA full version from:

<http://www.ni.com/download/>.

After download you can follow the steps below to install it:

- 1 Double click the visa_full.exe, dialog shown as below:

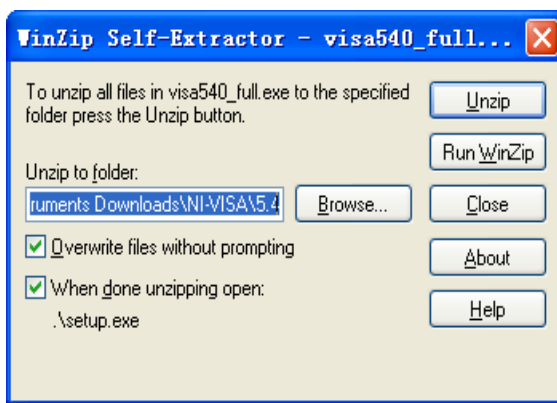

Figure 9-3

- 2 Click Unzip, the installation process will automatically launch after unzipping files. If your computer needs to install .NET Framework 4, its setup process will auto start.



Figure 9-4

- 3 The NI-VISA installing dialog is shown above. Click Next to start the installation process.

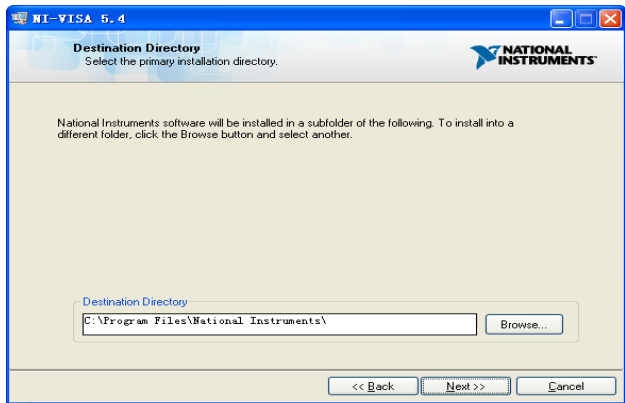

Figure 9-5

- 4 Set the install path, default path is “C:\Program Files\National Instruments\”, you can change it. Click Next, dialog shown as above.

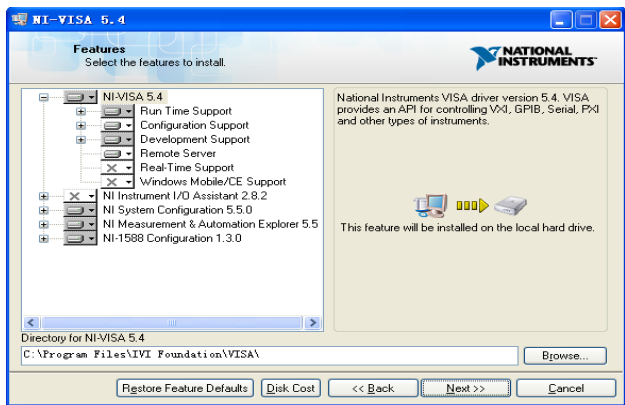

Figure 9-6

- 5 Click Next twice, in the License Agreement dialog, select the “I accept the above 2 License Agreement(s).”, and click Next, dialog shown as below:

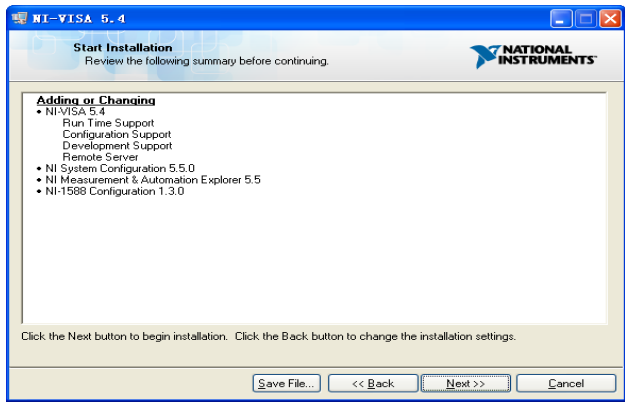

Figure 9-7

- 6 Click Next to run installation.

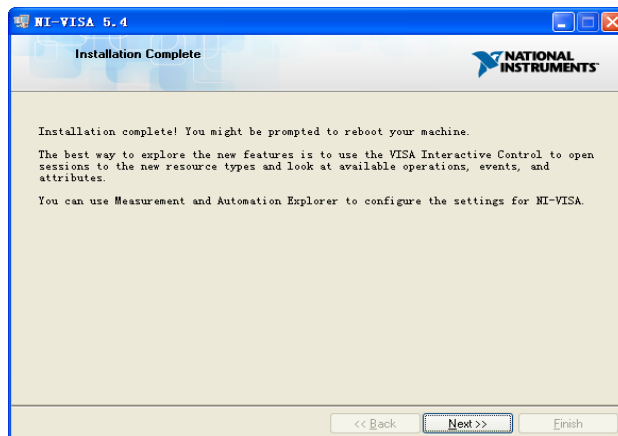

Figure 9–8

Now the installation is complete, reboot your PC.

9.2.2 Sockets/Telnet

Through the LAN interface, VXI-11, Sockets and Telnet protocols can be used to communicate with the analyzer. VXI-11 is provided in NI-VISA, while Sockets and Telnet are commonly included in PC's OS initially.

Socket LAN is a method used to communicate with the analyzer over the LAN interface using the Transmission Control Protocol/Internet Protocol (TCP/IP). A socket is a fundamental technology used for computer networking and allows applications to communicate using standard mechanisms built into network hardware and operating systems. The method accesses a port on the analyzer from which bidirectional communication with a network computer can be established.

Before you can use sockets LAN, you must select the analyzer's sockets port number to use:

- **Standard mode:** Available on port 5025. Use this port for programming.
- **Telnet mode:** The telnet SCPI service is available on port 5024.

9.3 Remote Control Capabilities

9.3.1 User-defined Programming

Users can use SCPI commands to program and control the analyzer. For details, refer to the introductions in "**Programming Examples**".

9.3.2 NI MAX

Users can control the analyzer remotely by sending SCPI commands via NI-MAX software. NI_MAX is National Instruments Measurement and Automation Explorer. It is an executable program that enables easy communication to troubleshoot issues with instrumentation.

9.3.2.1 Using USB

Run NI MAX software.

- 1 Click “Device and interface” at the upper left corner of the software;
- 2 Find the “USBTMC” device symbol

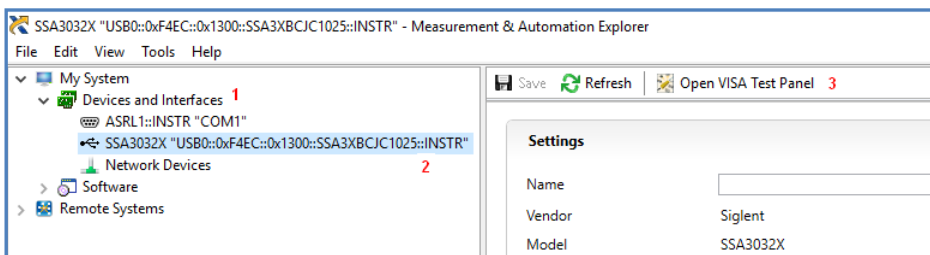

Figure 9–9

- 3 Click “Open VISA Test Panel” option button, then the following interface will appear.
- 4 Click the “Input/Output” option button and click the “Query” option button in order to view the operation information.

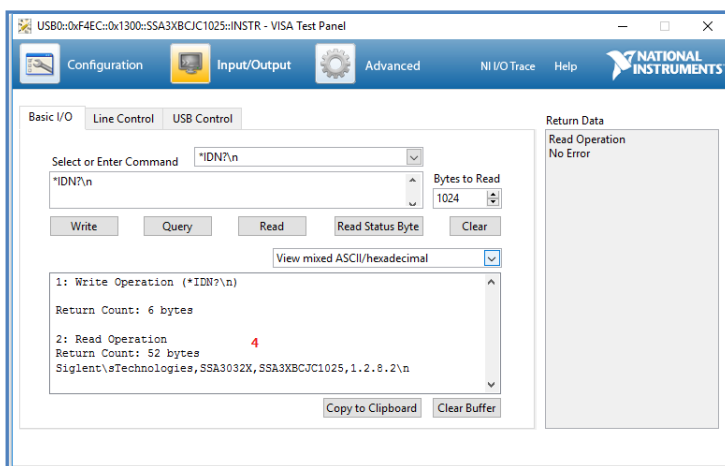

Figure 9–10

Note: The “*IDN?” command (known as the Identification Query) returns the instrument manufacturer, instrument model, serial number, and other identification information.

9.3.2.2 Using LAN

Select “Add Network Device”, and select “VISA TCP/IP Resource” as shown:

Run NI MAX software.

- 1 Click “Device and interface” at the upper left corner of the software;
- 2 Find the “Network Devices” symbol, click “Add Network Devices”;

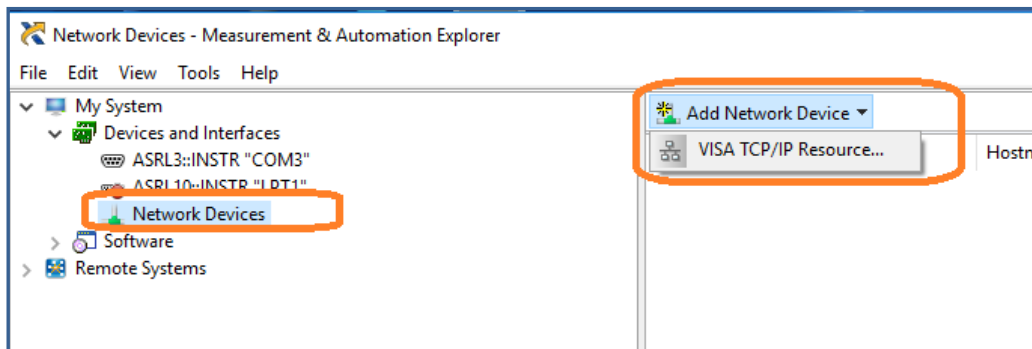

Figure 9–11

- 3 Select Manual Entry of LAN instrument, select Next, and enter the IP address as shown. Click Finish to establish the connection:

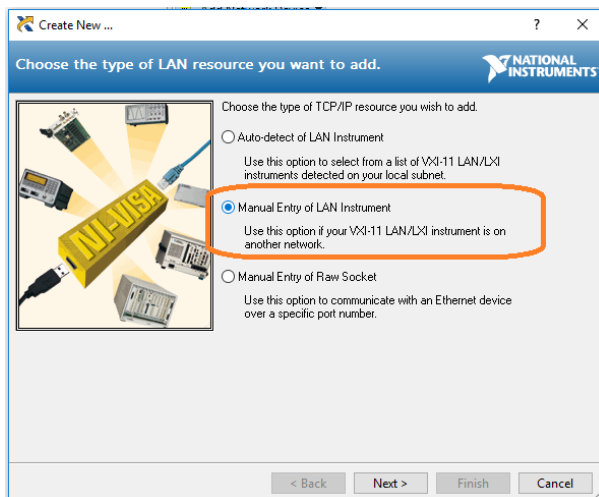

Figure 9–12

Note: Leave the LAN Device Name BLANK or the connection will fail.

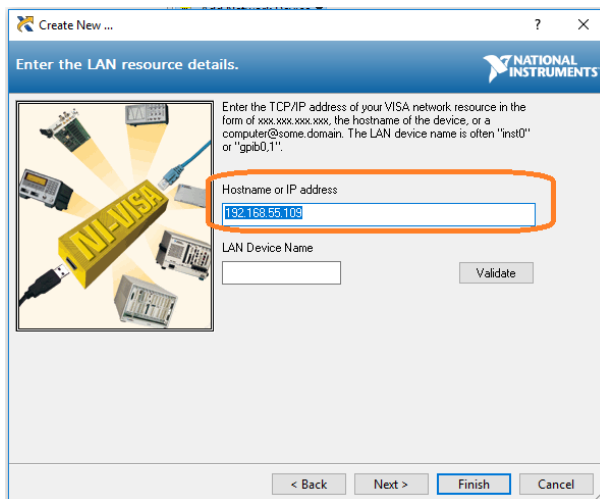

Figure 9-13

4 After a brief scan, the connection should be shown under Network Devices:

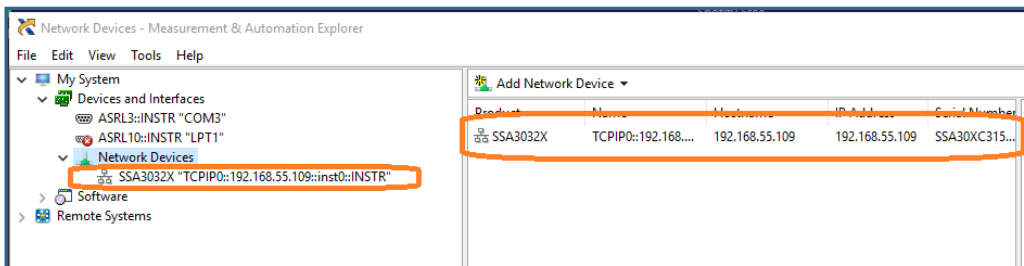

Figure 9-14

5 Right-click on the product and select Open NI-VISA Test Panel:

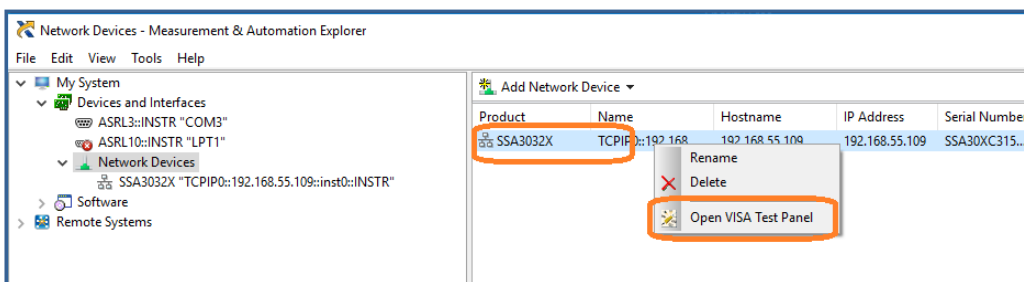

Figure 9-15

6 Click "Input/Output" option button and click "Query" option button. If everything is OK, you will see the Read operation information returned as shown below.

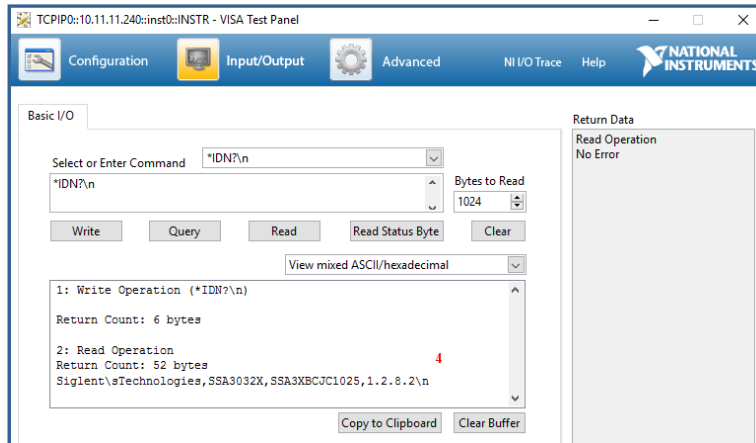

Figure 9–16

9.3.3 Web browser

The analyzer can be remotely controlled through PC or web browser of mobile terminal installing any driver. It mimics the touch screen/mouse clickable display function, just like a physical instrument. The browser also supports screenshot and firmware update functions.

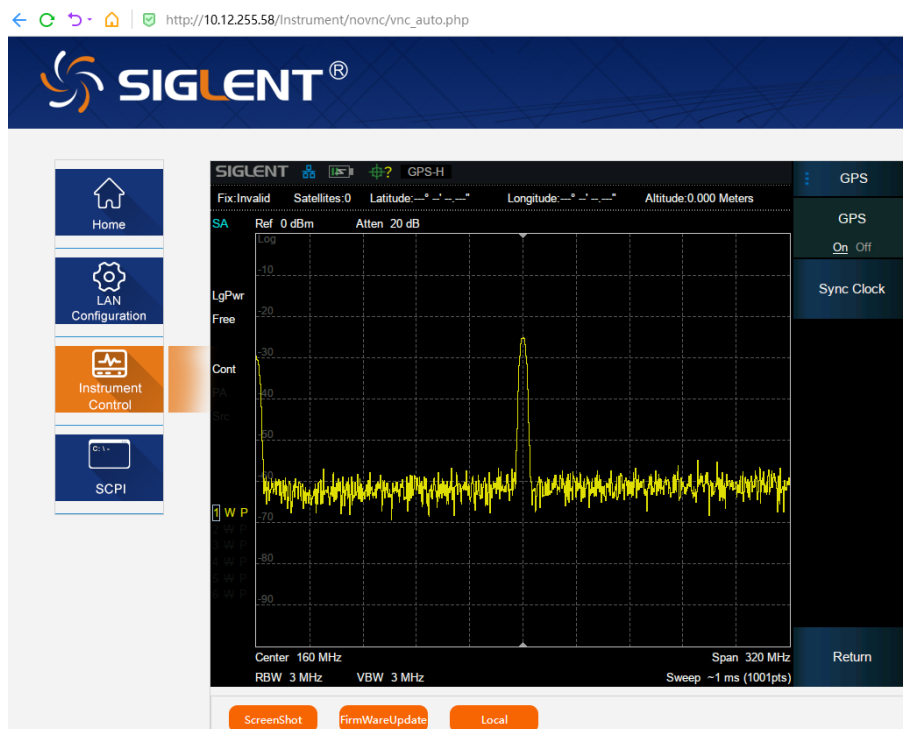

Figure 9–17

*It is recommended to use a web browser that supports HTML5, such as Chrome or Firefox.

10 SCPI Overview

10.1 Command Format

SCPI commands present a hierarchical tree structure containing multiple subsystems, each of the subsystems is made up of a root keyword and several subkeywords. The command string usually starts with “:”, the keywords are separated by “:” and the followed parameter settings are separated by space. Query commands add “?” at the end of the string.

For example:

```
:SENSe:FREQuency:CENTer <freq>
```

```
:SENSe:FREQuency:CENTer?
```

SENSe is the root key of the command, FREQuency and CENTer are second and third keywords. The command begins with “:”, and separates the keywords at the same time, <freq> separated by space and represents the parameter available for setting; “?” represents a query.

10.2 Symbol Instruction

The following four symbols are not the content of SCPI commands and cannot be sent with the commands, but are usually used in the commands.

1 Triangle Brackets < >

The parameter in the triangle brackets must be replaced by an effective value. For example:

Send the “:DEMod:VOLume <value>” command in “:DEMod:VOLume 5”.

2 Square Brackets []

The content in the square brackets can be ignored. When the parameter is ignored, the instrument will set the parameter to its default. For example,

In the “[:SENSe]:POWER[:RF]:ATTenuation?” command, sending any of the four commands below can generate the same effect:

```
:POWER:ATTenuation?
```

```
:POWER:RF:ATTenuation?
```

```
:SENSe:POWER:ATTenuation?
```

```
:SENSe:POWER:RF:ATTenuation?
```

3 Vertical Bar |

The vertical bar is used to separate multiple parameters and when sending the command, you can choose one of the parameters. For example,

In the “[:SENSe]:FREQuency:CENTer:STEP:AUTO OFF|ON|0|1” command, the parameters

available are “OFF”, “ON”, “0” or “1”.

4 Braces { }

The parameters in the braces are optional which can be ignored or set for one or more times. For example:

:CALCulate:LLINe[1]|2:DATA <x-axis>,<ampl>{,<x-axis>, <ampl>}, in the command, the {,<x-axis>, <ampl>} parameters can be ignored or set for one or more times.

10.3 Parameter Type

The parameters in the commands introduced in this manual include 6 types: boolean, enumeration, integer, float, discrete and string.

1 Boolean

The parameters in the commands could be “OFF”, “ON”, “0” or “1”. For example:

```
[[:SENSe]:FREQuency:CENTer:STEP:AUTO OFF|ON|0|1
```

2 Enumeration

The parameter could be any of the values listed. For example:

```
[[:SENSe]:AVERage:TYPE LOGPower|POWer|VOLTage
```

The parameter is “OGPower”, “POWer” or “VOLTage”.

3 String

The parameter should be the combinations of ASCII characters. For example:

```
:SYSTem:COMMunicate:LAN:IPADdress <“xxx.xxx.xxx.xxx”>
```

The parameter can be set as “192.168.1.12” string.

4 Integer

Except other notes, the parameter can be any integer within the effective value range. For example:

```
[[:SENSe]:DEMod:VOLume <value>
```

The parameter < value > can be set to any integer between 0 and 10.

5 Float

The parameter could be any value within the effective value range according to the accuracy requirement (the default accuracy contains up to 9 digits after the decimal points). For example:

:CALCulate:BANDwidth:NDB <value>

The parameter < value > can be set to any real number between -100 and 100.

6 Discrete

The parameter could only be one of the specified values and these values are discontinuous. For example:

[:SENSe]:BWIDth:VIDeo:RATio <number>

The parameter <number> could only be one of 0.001, 0.003, 0.01, 0.03, 0.1, 0.3, 1.0, 3.0, 10.0, 30.0, 100.0, 300.0, 1000.0.

10.4 Command Abbreviation

All of the commands are not case sensitive, so you can use any of them. But if abbreviation is used, all the capital letters in the command must be written completely. For example:

:DISPlay:WINDow:TRACe:Y:DLINe:STATe?

Can be abbreviated to:

:DISP:WIND:TRAC:Y:DLIN:STAT?

10.5 IEEE Common Commands

*IDN

*RST

*CLS

*ESE

*ESR?

*OPC

*SRE

*STB?

*WAI

*TRG

*TST?

Command Format		*IDN?
Instruction	Returns an instrument identification information string. The string will contain the manufacturer, model number, serial number, software number, FPGA number and CPLD number.	
Menu	None	
Example	*IDN? Return: Siglent,SVA1015,1234567890,100.01.01.06.01	

Command Format		*RST
Instruction	This command presets the instrument to a factory defined condition that is appropriate for remote programming operation.	
Menu	None	
Example	*RST	

Command Format		*CLS
Instruction	Clears the status byte register. It does this by emptying the error queue and clearing all bits in all of the event registers. The status byte register summarizes the states of the other registers. It is also responsible for generating service requests.	
Menu	None	
Example	*CLS	

Command Format		*ESE <number> *ESE?
Instruction	Set the bits in the standard event status enable register. This register monitors I/O errors and synchronization conditions such as operation complete, request control, query error, device dependent error, execution error, command error and power on. A summary bit is generated on execution of the command. The query returns the state of the standard event status enable register.	
Menu	None	
Example	*ESE 16	

Command Format		*ESR?
Instruction	Queries and clears the standard event status event register. (This is a destructive read.) The value returned reflects the current state (0/1) of all the bits in the register.	
Menu	None	
Example	*ESR?	

Command Format		*OPC *OPC?
Instruction	Set bit 0 in the standard event status register to "1" when all pending operations have finished. The query stops any new commands from being processed until the current processing is complete. Then it returns a "1", and the program continues. This query can be used to synchronize events of other instruments on the external bus. Returns a "1" if the last processing is complete. Use this query when there's a need to monitor the command execution status, such as a sweep execution.	

Menu	None
Example	*OPC?

Command Format	*SRE <integer> *SRE?
Instruction	This command enables the desired bits of the service request enable register. The query returns the value of the register, indicating which bits are currently enabled. The default value is 255.
Menu	None
Example	*SRE 1

Command Format	*STB?
Instruction	This query is used by some instruments for a self test.
Menu	None
Example	*STB?

Command Format	*WAI
Instruction	This command causes the instrument to wait until all pending commands are completed before executing any additional commands. There is no query form to the command.
Menu	None
Example	*WAI

Command Format	*TRG
Instruction	Restarts the current sweep.
Menu	None
Example	*TRG

Command Format	*TST?
Instruction	This query is used by some instruments for a self test.
Menu	None
Example	*TST?

10.6 SCPI LIST

10.6.1 GPSA

Mode/Meas	:INSTrument[:SElect] :INSTrument:MEASure
Freq	[:SENSe]:FREQuency:CENTer [:SENSe]:FREQuency:START [:SENSe]:FREQuency:STOP [:SENSe]:FREQuency:CENTer:STEP[:INCRement] [:SENSe]:FREQuency:CENTer:STEP:AUTO [:SENSe]:FREQuency:OFFSet [:SENSe]:FREQuency:SPAN [:SENSe]:FREQuency:SPAN:FULL [:SENSe]:FREQuency:SPAN:ZERO [:SENSe]:FREQuency:SPAN:PREVious [:SENSe]:FREQuency:SPAN:HALF [:SENSe]:FREQuency:SPAN:DOUBle [:SENSe]:FREQuency:TUNE:IMMEDIATE :DISPlay:WINDow:TRACe:X[:SCALe]:SPACing :CALCulate:MARKer:TRCKing[:STATe]
BW	[:SENSe]:BWIDth[:RESolution] [:SENSe]:BWIDth[:RESolution]:AUTO [:SENSe]:BWIDth:VIDeo [:SENSe]:BWIDth:VIDeo:AUTO [:SENSe]:BWIDth:VIDeo:RATio [:SENSe]:FILTer:TYPE
Sweep	[:SENSe]:SWEep:TIME [:SENSe]:SWEep:TIME:AUTO :INITiate:CONTinuous :INITiate[:IMMEDIATE] [:SENSe]:SWEep:MODE [:SENSe]:SWEep:MODE:AUTO [:SENSe]:SWEep:TYPE:AUTO:RULEs [:SENSe]:SWEep:SPEEd [:SENSe]:SWEep:POINts
Ampt	:DISPlay:WINDow:TRACe:Y[:SCALe]:RLEVel :DISPlay:WINDow:TRACe:Y[:SCALe]:PDIVision :DISPlay:WINDow:TRACe:Y[:SCALe]:SPACing :UNIT:POWer :DISPlay:WINDow:TRACe:Y:SCALe:RLEVel:OFFSet [:SENSe]:POWer[:RF]:ATTenuation [:SENSe]:POWer[:RF]:ATTenuation:AUTO [:SENSe]:POWer[:RF]:GAIN[:STATe]
Trigger	:TRIGger[:SEQuence]:SOURce :TRIGger[:SEQuence]:{type}:LEVel

	<p>:TRIGger[:SEQuence]:{type}:DELay :TRIGger[:SEQuence]:{type}:SLOPe :TRIGger[:SEQuence]:EXTErnal:DELay:COMPensation :TRIGger[:SEQuence]:FRAMe:PERiod :TRIGger[:SEQuence]:FRAMe:OFFSet :TRIGger[:SEQuence]:FRAMe:OFFSet:DISPlay:RESet :TRIGger[:SEQuence]:FRAMe:SYNC [:SENSe]:SWEep:EGATe:SOURce [:SENSe]:SWEep:EGATe[:STATe] [:SENSe]:SWEep:EGATe:VIEW [:SENSe]:SWEep:EGATe:DELay [:SENSe]:SWEep:EGATe:LENGth [:SENSe]:SWEep:EGATe:METhod [:SENSe]:SWEep:EGATe:VIEW:STARt</p>
Trace	<p>TRACe:SELEct :TRACe[1] 2 3 4 5 6:TYPE :TRACe[1] 2 3 4 5 6:DISPlay[:STATe] :TRACe[1] 2 3 4 5 6 [:DATA]? :FORMat[:TRACe][:DATA] [:SENSe]:DETector:TRACe[1] 2 3 4 5 6[:FUNCTion] [:SENSe]:DETector:TRACe[1] 2 3 4 5 6:AUTO [:SENSe]:DETector:TRACe:AUTO:ALL :TRACe[1] 2 3 4 5 6:MATH:X :TRACe[1] 2 3 4 5 6:MATH:Y :CALCulate[:SELEcted]:MATH:FUNCTion :TRACe[1] 2 3 4 5 6:MATH:OFFSet :TRACe[1] 2 3 4 5 6:MATH:REFerence :CALCulate:NTData:STORE:REF :CALCulate:NTData[:STATe] :DISPlay:WINDow:TRACe:Y[:SCALE]:NRLevel :DISPlay:WINDow:TRACe:Y[:SCALE]:NRPosition :DISPlay:WINDow:NTTRace[:STATe] :TRACe:COpy :TRACe:EXCHange :TRACe:PRESet:ALL :TRACe:CLEar:ALL</p>
Marker	<p>:CALCulate:MARKer:SELEct :CALCulate:MARKer[1] 2 3 4 5 6 7 8:STATe :CALCulate:MARKer[1] 2 3 4 5 6 7 8:TRACe :CALCulate:MARKer[1] 2 3 4 5 6 7 8:MODE :CALCulate:MARKer[1] 2 3 4 5 6 7 8:X :CALCulate:MARKer[1] 2 3 4 5 6 7 8:Y? :CALCulate:MARKer[1] 2 3 4 5 6 7 8:REFerence :CALCulate:MARKer:AOFF :CALCulate:MARKer:TABLE :CALCulate[:SELEcted]:MARKer:COUPle :CALCulate:MARKer[1] 2 3 4 5 6 7 8:X:READout</p>

	<p>:CALCulate:MARKer[1] 2 3 4 5 6 7 8:X:READout:AUTO :CALCulate:MARKer[1] 2 3 4 5 6 7 8:X:LINE:STATe :CALCulate:MARKer[1] 2 3 4 5 6 7 8:FUNCTion :CALCulate:MARKer[1] 2 3 4 5 6 7 8:BANDwidth[1] 2 3 4 5 6 7 8:NDB? :CALCulate:MARKer[1] 2 3 4 5 6 7 8:BANDwidth:RESult? :CALCulate:MARKer[1] 2 3 4 5 6 7 8:FCOunt[:STATe] :CALCulate:MARKer[1] 2 3 4 5 6 7 8:FCOunt:X? :CALCulate:MARKer[1] 2 3 4 5 6 7 8[:SET]:CENTer :CALCulate:MARKer[1] 2 3 4 5 6 7 8[:SET]:STEP :CALCulate:MARKer[1] 2 3 4 5 6 7 8[:SET]:START :CALCulate:MARKer[1] 2 3 4 5 6 7 8[:SET]:STOP :CALCulate:MARKer[1] 2 3 4 5 6 7 8[:SET]:RLEVel :CALCulate:MARKer[1] 2 3 4 5 6 7 8:DELTA[:SET]:SPAN :CALCulate:MARKer[1] 2 3 4 5 6 7 8:DELTA[:SET]:CENTer :CALCulate:MARKer[1] 2 3 4 5 6 7 8:MAXimum :CALCulate:MARKer[1] 2 3 4 5 6 7 8:MINimum :CALCulate:MARKer[1] 2 3 4 5 6 7 8:MAXimum:NEXT :CALCulate:MARKer[1] 2 3 4 5 6 7 8:MAXimum:LEFT :CALCulate:MARKer[1] 2 3 4 5 6 7 8:MAXimum:RIGHT :CALCulate:MARKer[1] 2 3 4 5 6 7 8:PTPeak :CALCulate:MARKer[1] 2 3 4 5 6 7 8:CPSearch[:STATe] :CALCulate:MARKer:PEAK:THReshold :CALCulate:MARKer:PEAK:THReshold:STATe :CALCulate:MARKer:PEAK:EXCursion :CALCulate:MARKer:PEAK:EXCursion:STATe :CALCulate:MARKer:PEAK:TABLE :CALCulate:PEAK:TABLE? :CALCulate:MARKer:PEAK:SORT :CALCulate:MARKer:PEAK:SORT:ORDER :CALCulate:MARKer:PEAK:TABLE:DTLimit:STATe :CALCulate:MARKer:PEAK:TABLE:DTLimit 1 2 3 4 5 6</p>
Limit	<p>:CALCulate:LLINe[1] 2 3 4 5 6:STATe :CALCulate:LLINe[1] 2 3 4 5 6:TYPE :CALCulate:LLINe[1] 2 3 4 5 6:MARGin :CALCulate:LLINe[1] 2 3 4 5 6:MARGin:STATe :CALCulate:LLINe[1] 2 3 4 5 6:Offset:X :CALCulate:LLINe[1] 2 3 4 5 6:Offset:Y :CALCulate:LLINe[1] 2 3 4 5 6:DATA :CALCulate:LLINe[1] 2 3 4 5 6:ADD :CALCulate:LLINe[1] 2 3 4 5 6:POINt:DELeTe :CALCulate:LLINe[1] 2 3 4 5 6:DELeTe :CALCulate:LLINe:ALL:DELeTe :CALCulate:LLINe[1] 2 3 4 5 6:TRACe :CALCulate:LLINe[1] 2 3 4 5 6:FREQuency:INTerpolate:TYPE :CALCulate:LLINe[1] 2 3 4 5 6:FREQuency:CMODE :CALCulate:LLINe[1] 2 3 4 5 6:AMPLitude:INTerpolate:TYPE :CALCulate:LLINe[1] 2 3 4 5 6:AMPLitude:CMODE</p>

	:CALCulate:LLINe[1] 2 3 4 5 6:COpy :CALCulate:LLINe[1] 2 3 4 5 6:BUILd :CALCulate:LLINe:TEST :CALCulate:LLINe:CONTRol:BEEP :CALCulate:LLINe:FAIL:STOP :CALCulate:LLINe[1] 2 3 4 5 6:FAIL?
Settings	[:SENSe]:AVERAge:TRACe[1] 2 3 4 5 6:COUNT [:SENSe]:AVERAge:TRACe[1] 2 3 4 5 6? [:SENSe]:AVERAge:TRACe[1] 2 3 4 5 6:CLEAr [:SENSe]:AVERAge:TYPE :COUPlE:ALL :DISPlay:WINDow:TRACe:Y:DLINe:STATe? :DISPlay:WINDow:TRACe:Y:DLINe :DISPlay:WINDow:TRACe:X:FLINe:STATe? :DISPlay:WINDow:TRACe:X:FLINe [:SENSe]:DEMod [:SENSe]:DEMod:EPHone [:SENSe]:DEMod:VOLume [:SENSe]:DEMod:TIME :INSTrument:COUPlE:FREQuency:CENTer
Chp	[:SENSe]:CHPower:BWIDth:INTegration [:SENSe]:CHPower:FREQuency:SPAN:POWer :UNIT:CHPower:POWer:PSD :CHPower:MEASure:CHPower? :CHPower:MEASure:CHPower:CHPower? :CHPower:MEASure:CHPower:DENSity? [:SENSe]:CHPower:AVERAge:TCONtrol [:SENSe]:CHPower:FREQuency:SPAN:POWer :UNIT:CHPower:POWer:PSD :CHPower:MEASure:CHPower? :CHPower:MEASure:CHPower:CHPower? :CHPower:MEASure:CHPower:DENSity? [:SENSe]:CHPower:AVERAge:TCONtrol
ACPR	[:SENSe]:ACPRatio:BWIDth:INTegration [:SENSe]:ACPRatio:OFFSet:BWIDth[:INTegration] [:SENSe]:ACPRatio:OFFSet[:FREQuency] :MEASure:ACPRatio:ACPower:MAIN? :MEASure:ACPRatio:LOWer:POWer? :MEASure:ACPRatio:UPPer:POWer? :MEASure:ACPRatio:LOWer? :MEASure:ACPRatio:UPPer? [:SENSe]:ACPower:AVERAge:TCONtrol
OBW	[:SENSe]:OBWIDth:PERCent [:SENSe]:OBWIDth:XDB :MEASure:OBWIDth? :MEASure:OBWIDth:OBWIDth?

	:MEASure:OBWidth:CENTroid? [:SENSe]:OBWidth:PREFerence [:SENSe]:OBWidth:INTEgration[:METHod] :MEASure:OBWidth:OBWidth:FERRor? [:SENSe]:OBWidth:AVERAge:TCONtrol
T-Power	[:SENSe]:TPOWer:FREQuency:CENTer [:SENSe]:TPOWer:LLIMit [:SENSe]:TPOWer:RLIMit :MEASure:TPOWer? [:SENSe]:TPOWer:AVERAge:TCONtrol
TOI	:MEASure:TOI? :MEASure:TOI:IP3? [:SENSe]:TOI:AVERAge:TCONtrol
Sepctrum Monitor	[:SENSe]:SPECTrogram:STATe [:SENSe]:SPECTrogram:REStart [:SENSe]:SPECTrogram:AVERAge:TCONtrol
CNR	[:SENSe]:CNRatio:BANDwidth:INTEgration [:SENSe]:CNRatio:BANDwidth:NOISE [:SENSe]:CNRatio:OFFSet :CNRatio:MEASure:CNRatio? :CNRatio:MEASure:CNRatio:CARRier? :CNRatio:MEASure:CNRatio:NOISE? [:SENSe]:CNRatio:AVERAge:TCONtrol
Harmonics	[:SENSe]:HARMonics:FREQuency:FUNDamental [:SENSe]:HARMonics:FREQuency:FUNDamental:AUTO [:SENSe]:HARMonics:FREQuency:STEP[:INCRement] [:SENSe]:HARMonics:FREQuency:STEP[:INCRement]:AUTO [:SENSe]:HARMonics:NUMBer [:SENSe]:HARMonics:SElect

10.6.2 VNA

Freq	:FREQuency:STARt :FREQuency:CENTer :FREQuency:STOP [:SENSe]:FREQuency:SPAN [:SENSe#]:FREQuency:SPAN:ZERO [:SENSe#]:FREQuency:SPAN:SWEPT [:SENSe]:FREQuency:SPAN:ZERO?
Sweep	[:SENSe]:SWEep:TIME [:SENSe]:SWEep:TIME:AUTO :INITiate:CONTinuous :INITiate[:IMMediate]

Ampt	:DISPlay:WINDow#:TRACe[1] 2 3 4:Y[:SCALe]:PDIVision :DISPlay:WINDow#:TRACe[1] 2 3 4:Y[:SCALe]:RLEVel :DISPlay:WINDow#:TRACe#:Y[:SCALe]:RPOStion :DISPlay:WINDow#:TRACe#:Y[:SCALe]:AUTO
Trace	:CALCulate#:PARAmeter:COUNt :CALCulate#:PARAmeter:SElect :CALCulate#[[:SElected]:MATH:MEMorize :DISPlay:WINDow#:TRACe[1] 2 3 4:STATe :DISPlay:WINDow#:TRACe[1] 2 3 4:MEMory[:STATe] :CALCulate#[[:SElected]:MATH:FUNCTion :TRACe[1] 2 3 4:HOLD
Marker	:CALCulate:MARKer[1] 2 3 4 5 6 7 8:MODE :CALCulate:MARKer[1] 2 3 4 5 6 7 8:STATe :CALCulate:MARKer:AOFF :CALCulate:MARKer[1] 2 3 4 5 6 7 8:X :CALCulate:MARKer[1] 2 3 4 5 6 7 8:Y :CALCulate[:SElected]:MARKer:COUPle :CALCulate:MARKer[1] 2 3 4 5 6 7 8:BANDwidth:NDB :CALCulate:MARKer[1] 2 3 4 5 6 7 8:BANDwidth:RESult? :CALCulate[:SElected]:MARKer[1] 2 3 4 5 6 7 8:DISCReTE :CALCulate:MARKer[1] 2 3 4 5 6 7 8:MAXimum :CALCulate:MARKer[1] 2 3 4 5 6 7 8:MINimum :CALCulate:MARKer[1] 2 3 4 5 6 7 8:CPSearch[:STATe] :CALCulate:MARKer[1] 2 3 4 5 6 7 8:CVSearch[:STATe] :CALCulate:MARKer[1] 2 3 4 5 6 7 8[:SET]:CENTer :CALCulate:MARKer[1] 2 3 4 5 6 7 8[:SET]:START :CALCulate:MARKer[1] 2 3 4 5 6 7 8[:SET]:STOP :CALCulate:MARKer[1] 2 3 4 5 6 7 8:DELTA[:SET]:SPAN
Limit	:CALCulate:LLINe[1] 2 3 4 5 6:STATe :CALCulate:LLINe[1] 2[:TYPE :CALCulate:LLINe[1] 2[:MODE :CALCulate:LLINe[1] 2:Y :CALCulate:LLINe[1] 2:DATA :CALCulate:LLINe[1] 2:ADD :CALCulate:LLINe[1] 2:DELeTE :CALCulate:LLINe[1] 2:ALL:DELeTE :CALCulate:LLINe:TEST :CALCulate:LLINe[1] 2 3 4 5 6:FAIL? :CALCulate:LLINe:CONTrol:BEEP :CALCulate:LLINe:FAIL:STOP

Meas	:CALCulate#:PARAmeter#:DEFine :CALCulate#[[:SELEcted]:]FORMat :CORRection:EXTension :CORRection:EXTension:PORT[1]2:TIME :CORRection:EXTension:AUTO:PORT :CORRection:RVELocity:COAX :SOURce#:POWEr[:LEVel][[:IMMEDIATE][[:AMPLitude]
Cal	:CORRection:COLLect:CKIT:GENDER :CORRection:COLLect:CKIT:LABel :CORRection:COLLect:METHod:TYPE :CORRection:COLLect:OPEN :CORRection:COLLect:SHORT :CORRection:COLLect:LOAD :CORRection:COLLect:THRU :CORRection:COLLect:SAVE :CORRection:COLLect:METHod:ECAL? :CORRection:COLLect:ECAL:MODULE :CORRection:COLLect:ECAL:LOAD :CORRection:COLLect:ECAL:CANCEL

10.6.3 CAT

Freq	[:SENSe]:FREQuency:START [:SENSe]:FREQuency:STOP
BW	[:SENSe#]:AVERAge[:STATe] [:SENSe#]:AVERAge:COUNT
Ampt	:DISPlay:WINDow#:TRACe[1] 2 :Y[:SCALe]:PDIVision :DISPlay:WINDow#:TRACe[1] 2 :Y[:SCALe]:RLEVel :DISPlay:WINDow#:TRACe#:Y[:SCALe]:RPOStion :DISPlay:WINDow#:TRACe#:Y[:SCALe]:AUTO
Sweep	:SWEep:POINts [:SENSe]:SWEep:TIME [:SENSe]:SWEep:TIME:AUTO :INITiate:CONTinuous :INITiate[:IMMediate]
Trace	:CALCulate#:PARAmeter:SELEct :DISPlay:WINDow#:TRACe[1] 2 :STATe :DISPlay:WINDow#:TRACe#:MEMory[:STATe] :CALCulate#[:SELEcted]:MATH:MEMorize :CALCulate#[:SELEcted]:MATH:FUNCTion
Marker	:CALCulate:MARKer:SELEct :CALCulate:MARKer[1] 2 3 4 5 6 7 8:TRACe :CALCulate:MARKer[1] 2 3 4 5 6 7 8:MODE :CALCulate:MARKer[1] 2 3 4 5 6 7 8:STATe :CALCulate:MARKer:AOFF :CALCulate:MARKer[1] 2 3 4 5 6 7 8:X :CALCulate:MARKer[1] 2 3 4 5 6 7 8:Y? :CALCulate[:SELEcted]:MARKer:COUPle :CALCulate:MARKer[1] 2 3 4 5 6 7 8:MAXimum :CALCulate:MARKer[1] 2 3 4 5 6 7 8:MINimum :CALCulate:MARKer[1] 2 3 4 5 6 7 8:CPSearch[:STATe] :CALCulate:MARKer[1] 2 3 4 5 6 7 8:CVSearch[:STATe]
Limit	:CALCulate:LLINe[1] 2 :TYPE :CALCulate:LLINe[1] 2 :MODE :CALCulate:LLINe[1] 2:Y :CALCulate:LLINe[1] 2:DATA :CALCulate:LLINe[1] 2:ADD :CALCulate:LLINe[1] 2 :TYPE :CALCulate:LLINe[1] 2:DELEte :CALCulate:LLINe[1] 2:ALL:DELEte

	:CALCulate:LLINe:TEST :CALCulate:LLINe[1] 2 3 4 5 6:FAIL? :CALCulate:LLINe:CONTRol:BEEP :CALCulate:LLINe:FAIL:STOP
Cal	:CORRection:COLLect:CKIT:LABel :CORRection:COLLect:CKIT:GENDer :CORRection:COLLect:METhod:TYPE :CORRection:COLLect:OPEN :CORRection:COLLect:SHORt :CORRection:COLLect:LOAD :CORRection:COLLect:THRU :CORRection:COLLect:SAVE :CORRection:COLLect:METhod:ECAL? :CORRection:COLLect:ECAL:MODULE :CORRection:COLLect:ECAL:LOAD :CORRection:COLLect:ECAL:CANCEL
Meas	:CALCulate[:SELeCted]:DTF:FORMat CALCulate:TRANsform:DISTance:STARt CALCulate:TRANsform:DISTance:STOP [:SENSe#]:CORRection:RVELocity:COAX :CORRection:LOSS:COAX CALCulate:DTF:TRANsform:WINDow CALCulate:TRANsform:DISTance:UNIT :CALCulate[:SELeCted]:TDR:FORMat CALCulate:TDR:STIMulus:TYPE CALCulate:TDR:WINDow:beta

10.6.4 MA

DMA	[:SENSe]:AVERAge[:STATe] [:SENSe]:AVERAge:COUNT [:SENSe]:DDEMod:MODulation :DDEMod[:FORMat]:SRATe [:SENSe]:DDEMod[:FORMat]:SYMBOL:POINTs [:SENSe]:DDEMod[:FORMat]:RLENgth [:SENSe]:DDEMod:FILTer[:MEASurement] [:SENSe]:DDEMod:FILTer:REFerence [:SENSe]:STATistic:STATe :CALCulate:REStart :READ:DDEMod? [:SENSe]:DDEMod:SYNC:BURSt[:STATe] [:SENSe]:DDEMod:SYNC:SLENgth [:SENSe]:DDEMod:SYNC:BURSt:THREshold [:SENSe]:DDEMod:SYNC:BURSt:MINLength [:SENSe]:DDEMod:SYNC:BURSt:MINGap [:SENSe]:DDEMod:SYNC:SWORd[:STATe] [:SENSe]:DDEMod:SYNC:SWORd:OFFSet [:SENSe]:DDEMod:SYNC:SWORd:PATTern [:SENSe]:DDEMod:SEGMENT:BER:STATe [:SENSe]:DDEMod:SEGMENT:BER:PATTern
AMA	[:SENSe]:ADEMod:STYLe :CALCulate:IFBW:INDEx :CALCulate:EQLPf:INDEx :READ:ADEMod?
Freq	[:SENSe]:FREQuency:CENTer [:SENSe]:FREQuency:CENTer:STEP[:INCRement] [:SENSe]:FREQuency:SPAN?
BW	[:SENSe]:BWIDTH[:RESolution] [:SENSe]:DDEMod:FFT:WINDow:TYPE
Sweep	:INITiate[:IMMEDIATE] :INITiate:CONTinuous
Trigger	:TRIGger[:SEQuence]:SOURce :TRIGger[:SEQuence]:{type}:LEVel :TRIGger[:SEQuence]:{type}:DELay :TRIGger[:SEQuence]:{type}:SLOPe :TRIGger[:SEQuence]:FRAME:PERiod :TRIGger[:SEQuence]:FRAME:OFFSet :TRIGger[:SEQuence]:FRAME:OFFSet:DISPlay:RESet :TRIGger[:SEQuence]:FRAME:SYNC :TRIGger[:SEQuence]:ATRigger:STATe :TRIGger[:SEQuence]:ATRigger :TRIGger[:SEQuence]:HOLDoff:STATe :TRIGger[:SEQuence]:HOLDoff

	:TRIGger[:SEQuence]:HOLDoff:TYPE
Ampt	[:SENSe]:POWer[:RF]:ATTenuation [:SENSe]:POWer[:RF]:ATTenuation:AUTO :TRACe1 2 3 4:Y[:SCALe]:RLEVel :TRACe1 2 3 4:Y[:SCALe]:PDIVision :TRACe1 2 3 4[:Y]:AUToscale [:SENSe]:POWer[:RF]:GAIN[:STATe]
Trace	:CALCulate:PARAmeter:COUNT :DISPlay:LAYout :TRACe[1] 2 3 4:DATA:NAME :TRACe[1] 2 3 4:FORMat[:Y] :TRACe:DEMod:EYE:LENGth :TRACe:DEMod:TABLE:FORMat
Marker	:TRACe[1] 2 3 4:MARKer[1] 2 3 4:ENABLE :TRACe[1] 2 3 4:MARKer[1] 2 3 4:TYPE :TRACe[1] 2 3 4:MARKer[1] 2 3 4:X :TRACe[1] 2 3 4:MARKer[1] 2 3 4:Y? :TRACe[1] 2 3 4:MARKer[1] 2 3 4:REFerence :CALCulate[:SELected]:MARKer:COUPlE

10.6.5 Other

IO	[:SENSe]:ROSCillator:SOURce:TYPE [:SENSe]:CORRection:IMPedance[:INPut][:MAGNitude]
Correction	[:SENSe]:CORRection:CSET#[:STATe] [:SENSe]:CORRection:CSET#:ADD [:SENSe]:CORRection:CSET:ALL:DELeTe [:SENSe]:CORRection:CSET#:DATA? [:SENSe]:CORRection:CSET#:DELeTe [:SENSe]:CORRection:CSET:ALL:DELeTe
System	:SYSTem:CONFIgure:SYSTem? :SYSTem:LANGuage :SYSTem:COMMunicate:LAN:TYPE :SYSTem:COMMunicate:LAN:IPADdress :SYSTem:COMMunicate:LAN:GATeway :SYSTem:COMMunicate:LAN:SMASK :SYSTem:WEB:PSW :SYSTem:TIME :SYSTem:DATE :SYSTem:LKEY :SYSTem:COMMunicate:GPIB:ADDReSS
Reset	:SYSTem:PRESet :SYSTem:PRESet:TYPE :SYSTem:PRESet:USER[1] 2 3 4 5 6 7:SAVE :SYSTem:PRESet:USER[1] 2 3 4 5 6 7:LOAD :SYSTem:PON:TYPE :SYSTem:FDEFault :SYSTem:CLEAR
Calibration	:CALibration:STATe :CALibration
File	:MMEMory:STORe :MMEMory:LOAD :MMEMory:DELeTe
Display	:DISPlay:WINDow:TRACe:GRATICule:GRID:BRIGHtneSS :DISPlay:WINDow:TRACe:SCREEn:BRIGHtneSS
Power	:SYSTem:POWER:OFF :SYSTem:REStArt
Buzzer	:DISPlay:WINDow:BEEP:STATe :DISPlay:WINDow:BEEP:VOLUme

11 Service and Support

11.1 Service Summary

SIGLENT warrants that the products that it manufactures and sells will be free from defects in materials and workmanship for a period of three years (accessories for a period of one year) from the date of shipment from an authorized Siglent distributor. If the product proves defective within the respective period, **SIGLENT** will provide repair or replacement as described in the complete warranty statement.

To arrange for service or obtain a copy of the complete warranty statement, please contact your nearest Siglent sales and service office. Except as provided in this summary or the applicable warranty statement, **SIGLENT** makes no warranty of any kind, express or implied, including without limitation the implied warranties of merchantability and fitness for a particular purpose. In no event shall **SIGLENT** be liable for indirect, special or consequential damages.

11.2 Troubleshooting

Before calling **SIGLENT**, or returning an analyzer for service, perform the quick checks listed below. This check may eliminate the problem.

If the problem remains still, please contact **SIGLENT** and provide your device information in the back of the analyzer.

1 The Power Switch is still dark after power on:

- 1) Check that the power is correct / working.
- 2) Check the power cord has been connected correctly
- 3) Check the power fuse. If a new fuse needs to be installed, please use a specified fuse.

2 The analyzer's screen is still dark (no display) after power on:

- 1) Check whether the fan is running while the screen is dark, maybe the LCD cable is loose?
- 2) Check whether the fan is not running while screen is dark, maybe it has failed to start up?

Do not disassemble the instrument by yourself and contact **SIGLENT**.

3 The control panel is unresponsive or gives a wrong response:

- 1) Press all the keys at the front panel to check if all of them are normal after power on.
- 2) Press **System** > **Self Test** > **Key Test** to check if all the keys are working properly.
- 3) If all the keys are not working, the numeric keyboard connection might be loose or the numeric keyboard is broken.
- 4) If the touch screen is not working, check if the Touch is ON in **Display** > **Touch** Settings menu.

- 5) Check whether the analyzer is locked in a remote control; if so, press **Esc** to unlock it.
Do not disassemble the instrument by yourself and contact **SIGLENT**.

4 The traces on the screen do not update for a long period of time:

- 1) Check whether the traces are in View or other status; if so, change to Clear&Write to activate it.
- 2) Verify whether all the trigger conditions have been met and whether there is a valid trigger signal inputting.
- 3) Check whether the analyzer is in a Limit test.
- 4) Check whether the analyzer is in a single sweep.
- 5) Check whether the current sweep time is too long.
- 6) Check whether the analyzer is in a Demod listening and the Demod time is too long.
- 7) Check whether the analyzer is in an EMI measurement mode, and the Sequence is not in a Scan status.

5 Wrong measurement results or poor precision:

To calculate the system errors and check the measurement results and precision, refer to the introductions in “**Specifications**”. To reach these specifications, please:

- 1) Check whether all the external devices are successfully connected and are working normally.
- 2) Get some knowledge of the signal under measurement and set appropriate instrument parameters.
- 3) Make measurements under proper conditions, for example:

Warm-up the instrument appropriately and operate the instrument under the specified environment temperature;

Check if the Correction is ON in SA or VNA mode.
- 4) Calibrate the instrument regularly to reduce or avoid errors that might occur over time.
- 5) If you need a specific calibration after the stated calibration period, contact **SIGLENT** or get paid service from authorized measurement agencies.

6 System Message:

The instrument may display prompt messages, error messages or state messages according to the current working status. These messages are displayed to help you to use the instrument correctly and are not instrument failures.

Table 11-1 System Message

User system message	Message on screen
System message description (1~199)	
SWT_OOR (1)	Sweep time out of range
RBW_OOR(2)	RBW out of range
SWT_CCOFM(3)	Can't change the sweep time in FFT mode
MRKT_UNDEF(4)	Undefined marker type
MRKFT_UNDEF (5)	Undefined marker function type
MRKDT_UNDEF (6)	Undefined marker delta pair type
MRKRT_UNDEF (7)	Undefined marker read out type
TRCT_UNDEF (8)	Undefined trace type
DETT_UNDEF (9)	Undefined detect type
SCA_CSWL (10)	Can't set the Scale/Div with linear
MRKT_IOFF (11)	The marker type is OFF, please open the current marker
MRK_NDELTA (12)	The marker type is not Delta
MRKRT_MBST (13)	The marker read out type must be set time
MATHT_UNDEF (14)	Undefined math type
XML_ANIE (15)	Xml attribute node import error
XSCA_MBSLIZS (16)	X Scale must be set liner in zero span
TG_AXIS_XSCA (17)	The Scale type must be logarithm when normalize
SCALE_TG_AXIS (18)	Scale type cannot be changed to linear while nomalize on
PEAK_UNFOUND (19)	No peak found. Please change the search setting
IMD_FREQ_OOR (20)	Frequency of intermodulation products out of range
AUTO_FAIL (21)	Auto tune process failed
EXT_REF_PLUG_IN (22)	EXT ref plug in
EXT_REF_PLUG_OUT (23)	EXT ref plug out
REF_PLL_UNLOCK (24)	Ref pll unlock
SIG_NOT_STB (25)	Signal is not stable enough to track
QP_RBW_OOR (26)	RBW out of range when do quasi peak scan
LAN_PLUG_IN (150)	Ethernet cable plug in
LAN_PLUG_OUT (151)	Ethernet cable plug out
IP_CONFLICT (152)	IP address conflict
IP_INVALID (153)	IP address invalid
NETM_INVALID (154)	Netmask address invalid
GWAY_INVALID (155)	Gateway address invalid
S21_NORMALIZE_DONE (183)	Normalization of S21 done
VNA_AUTO_CAL_DONE (184)	Auto calibration of VNA done
Execution error (400~599)	

LCF_DTFERR (400)	Load configurations failed, due to file error
Device error (600~799)	
FUF_DTVERR (600)	Firmware upgrade failed, due to the version error
FUF_DTRERR (601)	Firmware upgrade failed, due to the ram error
FUF_DTFERR (602)	Firmware upgrade failed, due to the file error
FUF_DTFVERR (603)	Firmware upgrade failed, due to verify the file error
FUF_DTUZFERR (604)	Firmware upgrade failed, due to unzip the file error
LIC_INVALID (605)	License is invalid!
ADC_ERROR (606)	Warning, ADC Overload!



About SIGLENT

SIGLENT is an international high-tech company, concentrating on R&D, sales, production and services of electronic test & measurement instruments.

SIGLENT first began developing digital spectrum & network analyzers independently in 2002. After more than a decade of continuous development, SIGLENT has extended its product line to include digital spectrum & network analyzers, isolated handheld spectrum & network analyzers, function/arbitrary waveform generators, RF/MW signal generators, spectrum analyzers, vector network analyzers, digital multimeters, DC power supplies, electronic loads and other general purpose test instrumentation. Since its first spectrum & network analyzer was launched in 2005, SIGLENT has become the fastest growing manufacturer of digital spectrum & network analyzers. We firmly believe that today SIGLENT is the best value in electronic test & measurement.

Headquarters:

SIGLENT Technologies Co., Ltd

Add: Bldg No.4 & No.5, Antongda Industrial Zone, 3rd Liuxian Road, Bao'an District, Shenzhen, 518101, China

Tel: + 86 755 3688 7876

Fax: + 86 755 3359 1582

Email: sales@siglent.com

Website: int.siglent.com

North America:

SIGLENT Technologies America, Inc

6557 Cochran Rd Solon, Ohio 44139

Tel: 440-398-5800

Toll Free: 877-515-5551

Fax: 440-399-1211

Email: info@siglentna.com

Website: www.siglentna.com

Europe:

SIGLENT Technologies Germany GmbH

Add: Staetzlinger Str. 70

86165 Augsburg, Germany

Tel: +49(0)-821-666 0 111 0

Fax: +49(0)-821-666 0 111 22

Email: info-eu@siglent.com

Website: www.siglenteu.com

Follow us on
Facebook: [SiglentTech](https://www.facebook.com/SiglentTech)

