

J1

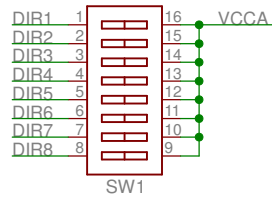

SW1

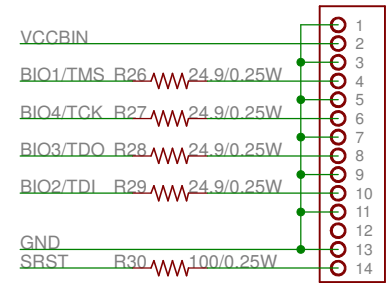

J2

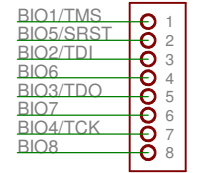
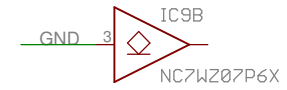
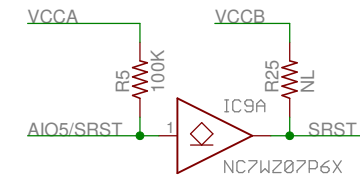
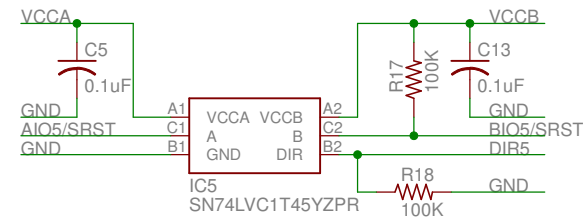
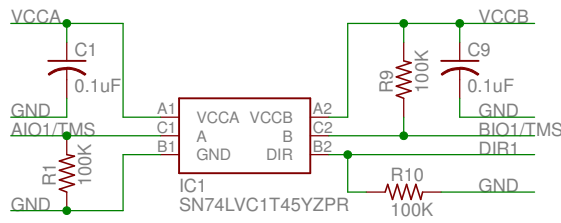

J3

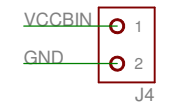
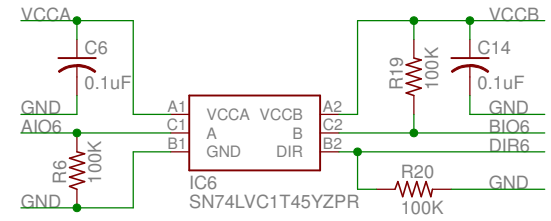
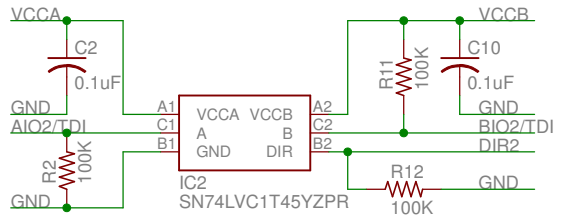

J4

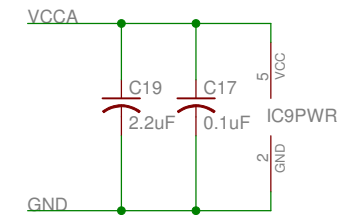
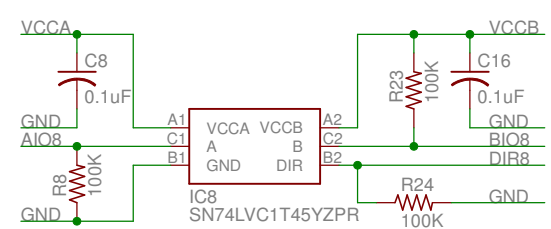
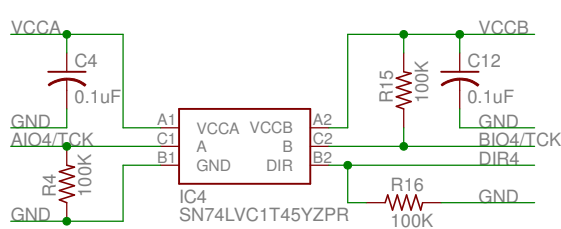
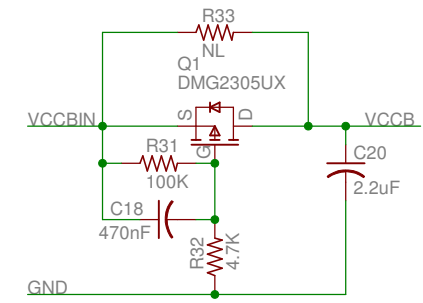
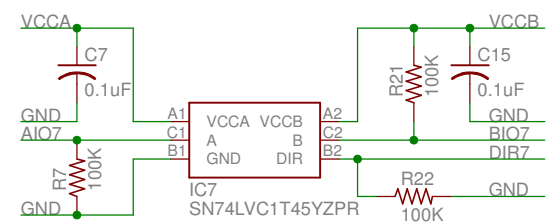
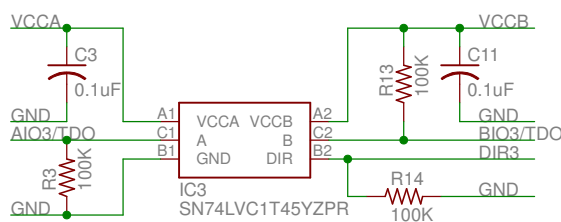

Note: All capacitors must be rated 10V or higher.

PmodLVLSHFT		Engineer: MTA
Copyright 2015, Digilent Inc.		Author: GMA
SHEET: Main		Rev: B.0
TITLE: PmodLVLSHFT		Doc#: 500-320
Date: 06/30/2015		Sheet: 1/1

ROHS CHINA WEEE