

1

2

3

4

5

6

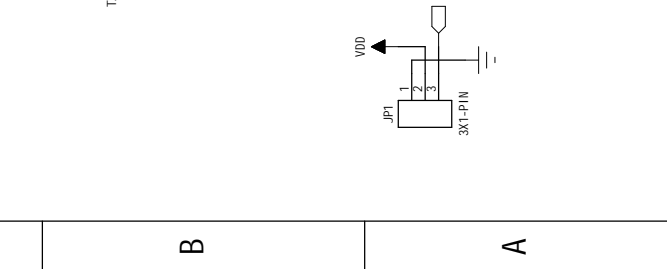
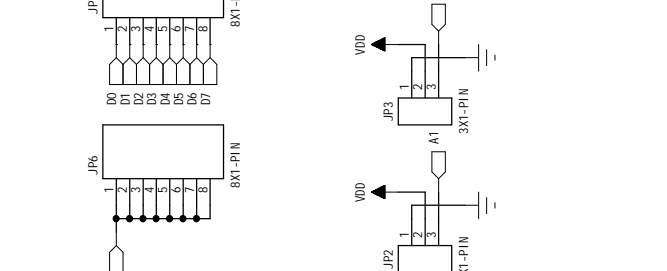
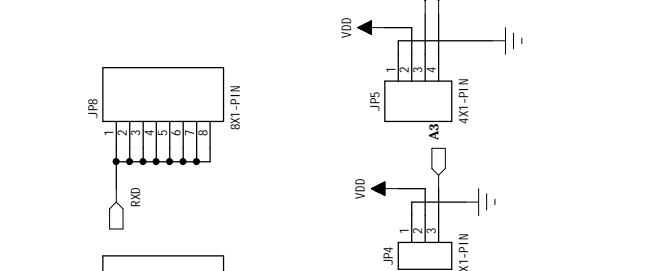
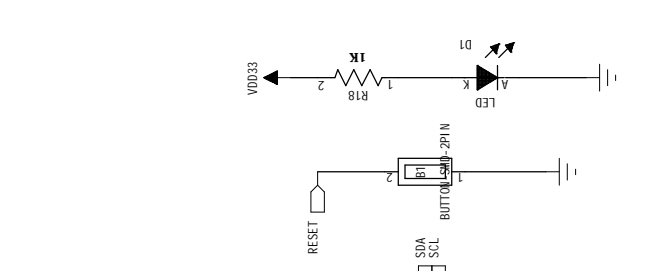
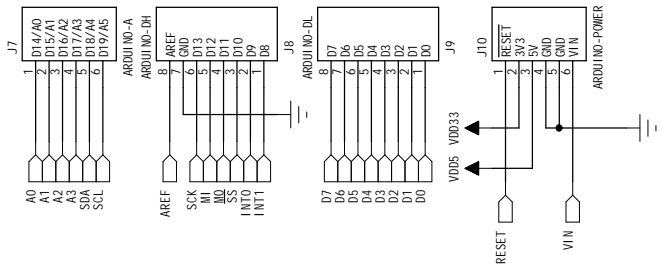
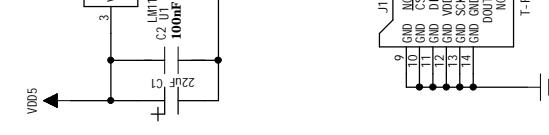
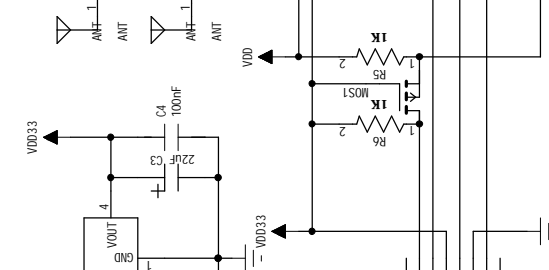
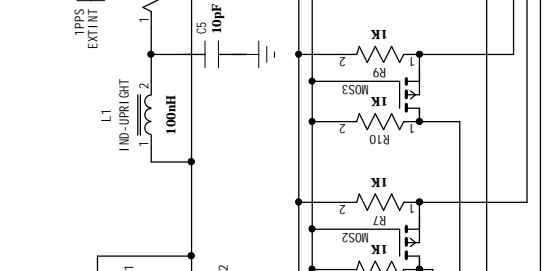
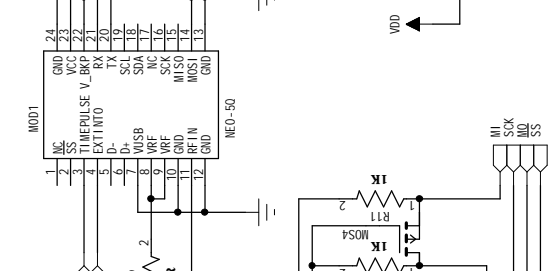
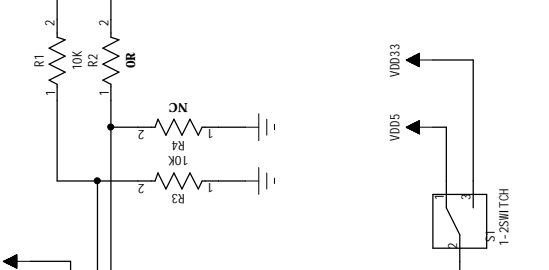
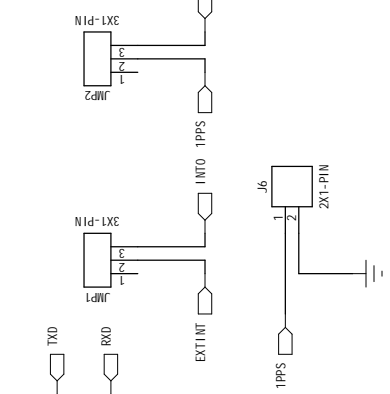
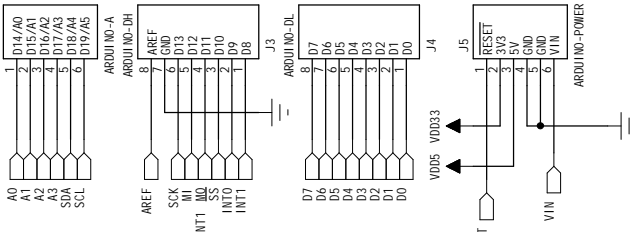

Company:	
Project Name:	Rev:
Sheet Name:	<undefined>
Designed by	
File Name:	gps_shield.sch page size:B
Date :	