

power light source

LUXEON[®] Portable PWT

Introduction

LUXEON[®] Portable PWT1, is the smallest power LED designed for consumer applications. The new emitter generates 26 lumens at 350mA from a package size of only 2.0 x 1.6 x 0.7mm, providing market-leading light output for its size along with a 2,000-hour life and uniform white light produced by Lumileds' patented conformal coating process. LUXEON Portable PWT1 is roughly 75% smaller than other LEDs with similar light output and delivers 4.5 times the lumens/mm². This enables designs with smaller optics, smaller form factors and less weight than ever before. The nearly perfect lambertian radiation pattern enables efficient optical designs. Surface-mount capability allows for simplified manufacturing and it offers the toughest electrostatic discharge (ESD) protection in the industry with an 8kV ESD protection chip.



Features

- ◆ Lifetime of 2000 hrs
- ◆ 2mm in size
- ◆ Color temperature of 6500K
- ◆ Advanced protection against electrostatic discharge (ESD)
- ◆ Instant turn on time
- ◆ High efficacy

Typical Applications

- ◆ Ideally suited to portable lighting and lighting for consumer products

Table of Contents

Product Nomenclature3
Average Lumen Maintenance Characteristics3
Environmental Compliance3
LUXEON Portable PWT Typical Design Parameters3
Ordering Information5
Physical Characteristics5
Operating Characteristics5
Electrical Data5
Typical LUXEON Portable PWT1 Electrical and Light Output Characteristics6
Consolidated Design Data7

Product Nomenclature

The part number designation is explained as follows:

L X C L - A B C D

Where:

- A — designates radiation pattern (value P for Lambertian)
- B — designates color (see Lumileds AB21)
- C — is a running number reserved for future products
- D — is a running number reserved for future products

Average Lumen Maintenance Characteristics

Lifetime for solidstate lighting devices (LEDs) is typically defined in terms of lumen maintenance—the percentage of initial light output remaining after a specified period of time.

Lumileds' testing has verified that LUXEON Portable PWT products will deliver, on average, 70% lumen maintenance at 2000 hours of operation at a forward current of 350 mA. This testing is based on constant current operation with junction temperature maintained at or below 55°C.

This performance is based on internal LUXEON reliability testing. Observation of design limits included in this data sheet is required in order to achieve this projected lumen maintenance.

Environmental Compliance

Lumileds is committed to providing environmentally friendly products to the solidstate lighting market. The LUXEON Portable PWT is compliant to the European Union directives on the restriction of hazardous substances in electronic equipment, namely the RoHS directive. Lumileds will not intentionally add the following restricted materials to the LUXEON Portable PWT: lead, mercury, cadmium, hexavalent chromium, polybrominated biphenyls (PBB) or polybrominated diphenyl ethers (PBDE).

LUXEON Portable PWT Typical Design Parameters

Table 1.

Name	Voltage	Current	Beam Angle	Assembly Method	Luminous Intensity	Emitter Life (100% functional, > 70% lm maint.)	Part Number
	V	A			(cd)	h	
LUXEON Portable PWT	3.4	0.35	120°	Surface Mount Device (SMD)	9	2000	LXCL-PWT1

LUXEON Portable PWT Typical Design Parameters, Cont'd

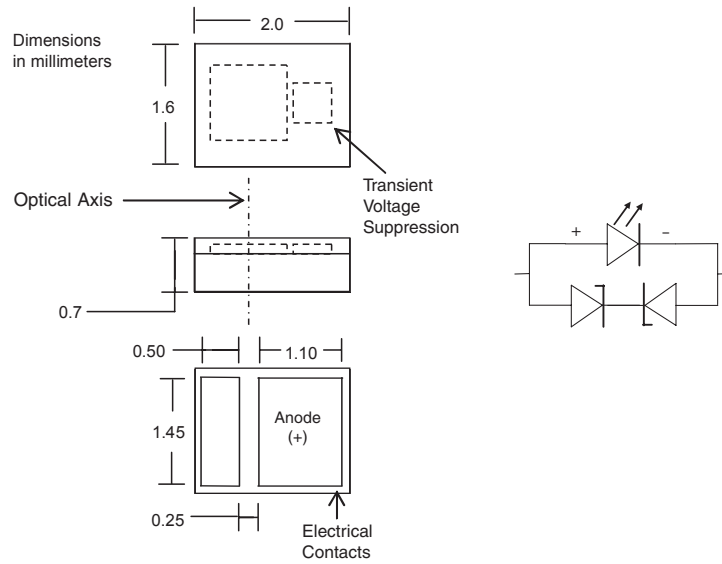

Figure 1.

Spectral Power Distribution

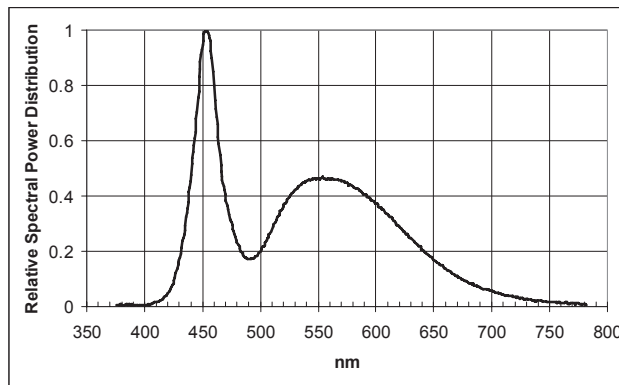

Figure 2. Spectral Power Distribution.

Polar Intensity Diagram (cd)

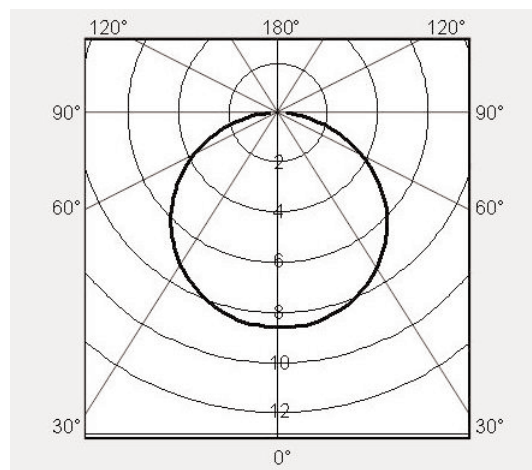

Figure 3. Polar Intensity Diagram (cd).

Ordering Information

Table 2.

Product Number	LXCL-PWT1
Description	LUXEON Portable PWT
Package Quantity	5,000

Physical Characteristics

Table 3.

Emitter Size	2.0 X 1.6 X 0.7 mm
Material	Phosphor Coated Indium Gallium Nitride (InGaN)
Max. Permissible Emitter Temp.	135°C

Operating Characteristics

Table 4.

Rated Initial Lumens	26
Rated Average Life, Hours	2000
Correlated Color Temp. (CCT)	6500K
Color Rendering Index	70
Efficacy (lpw)	22
Beam Angle	120°

Electrical Data

Table 5.

Emitter Voltage (Nominal)	3.4
Emitter Operating Current (Amps) (Nominal)	0.35
Turn on time to 100% of output	20 nsec.
Minimum Operating Temperature	-40°C

Typical LUXEON Portable PWT1 Electrical and Light Output Characteristics

Lumen Maintenance

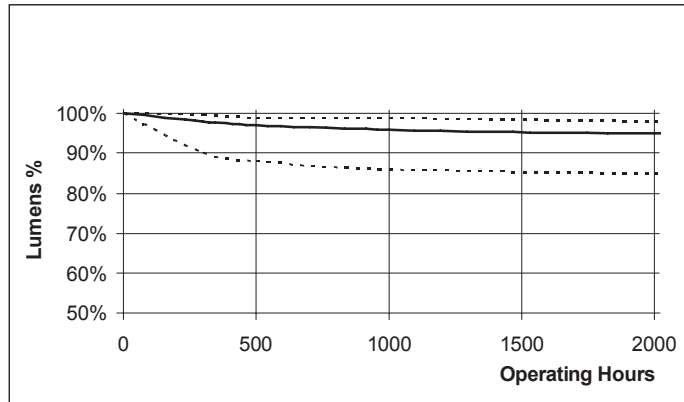

Figure 4. Lumen Maintenance.

Note for Figure 4:

1. Lifetime test performed at 350mA drive current and 25°C ambient temperature.

Forward Current vs. Forward Voltage

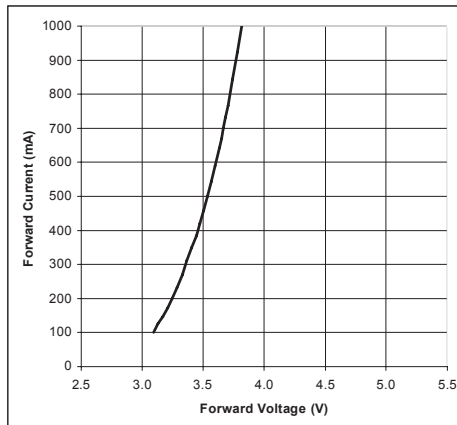

Figure 5. Forward Current vs. Forward Voltage.

Lumens vs. Forward Current

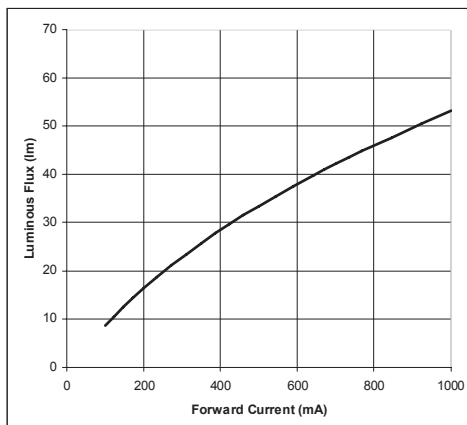

Figure 6. Lumens vs. Forward Voltage.

Consolidated Design Data

Chromaticity Range

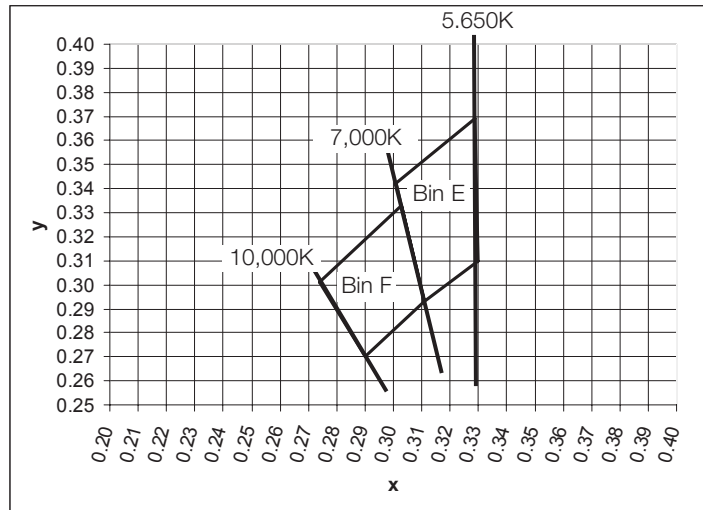

Figure 7. Chromaticity Range.

Table 6.

Bin F		Bin E	
x	y	x	y
0.303	0.333	0.329	0.369
0.274	0.301	0.301	0.342
0.290	0.270	0.311	0.293
0.311	0.293	0.330	0.310

Electrical and Optical Characteristics (Measured at $I_f = 350\text{mA}$ and $T_J = 25^\circ\text{C}$)

Table 7.

Parameter	Min	Typ	Max	Units
Luminous Flux (Tol. $\pm 10\%$)	16	26		lm
Forward Voltage (Tol. $\pm 0.06\text{V}$)	2.5	3.4	4.5	V
Color Temperature	5650	7000	10000	K
Dynamic Resistance		0.8		Ω
Temp Coefficient of Forward Voltage		-2.0		mV/ $^\circ\text{C}$
Thermal Resistance, Junction to Case		11		$^\circ\text{C}/\text{W}$

Absolute Maximum Ratings

Table 8.

Parameter	Value	Units
Max DC Operating Current	350	mA
ESD (JEDEC 3b)	8	kV
LED Junction Temperature	135	$^\circ\text{C}$
Storage Temperature	-40 to +120	$^\circ\text{C}$
Max Reflow Soldering Temperature	260 for 5 sec. max	$^\circ\text{C}$
Operating Temperature	-40 to +85	$^\circ\text{C}$



Company Information

LUXEON® is developed, manufactured and marketed by Philips Lumileds Lighting Company. Philips Lumileds is a world-class supplier of Light Emitting Diodes (LEDs) producing billions of LEDs annually. Philips Lumileds is a fully integrated supplier, producing core LED material in all three base colors (Red, Green, Blue) and White. Philips Lumileds has R&D centers in San Jose, California and in The Netherlands and production capabilities in San Jose and Penang, Malaysia. Founded in 1999, Philips Lumileds is the high-flux LED technology leader and is dedicated to bridging the gap between solid-state LED technology and the lighting world. Philips Lumileds technology, LEDs and systems are enabling new applications and markets in the lighting world.

Philips Lumileds may make process or materials changes affecting the performance or other characteristics of our products. These products supplied after such changes will continue to meet published specifications, but may not be identical to products supplied as samples or under prior orders.



WWW.LUXEON.COM
WWW.LUMILEDSFUTURE.COM

FOR TECHNICAL ASSISTANCE OR THE LOCATION OF YOUR NEAREST SALES OFFICE CONTACT ANY OF THE FOLLOWING:

NORTH AMERICA:
+1 888 589 3662 OR
ASKLUXEON@FUTUREELECTRONICS.COM

EUROPE:
OO 800 443 88 873 OR
LUXEON.EUROPE@FUTUREELECTRONICS.COM

ASIA:
800 5864 5337 OR
LUMILEDS.ASIA@FUTUREELECTRONICS.COM

©2006 Philips Lumileds Lighting Company. All rights reserved. Product specifications are subject to change without notice. Luxeon is a registered trademark of the Philips Lumileds Lighting Company in the United States and other countries.