

74AC109 • 74ACT109 Dual JK Positive Edge-Triggered Flip-Flop

General Description

The AC/ACT109 consists of two high-speed completely independent transition clocked JK flip-flops. The clocking operation is independent of rise and fall times of the clock waveform. The JK design allows operation as a D-Type flip-flop (refer to AC/ACT74 data sheet) by connecting the J and K inputs together.

Asynchronous Inputs:

- LOW input to \overline{S}_D (Set) sets Q to HIGH level
- LOW input to \overline{C}_D (Clear) sets Q to LOW level
- Clear and Set are independent of clock
- Simultaneous LOW on \overline{C}_D and \overline{S}_D makes both Q and \overline{Q} HIGH

Features

- I_{CC} reduced by 50%
- Outputs source/sink 24 mA
- ACT109 has TTL-compatible inputs

Ordering Code:

Order Number	Package Number	Package Description
74AC109SC	M16A	16-Lead Small Outline Integrated Circuit (SOIC), JEDEC MS-012, 0.150 Narrow
74AC109SJ	M16D	16-Lead Small Outline Package (SOP), EIAJ TYPE II, 5.3mm Wide
74AC109MTC	MTC16	16-Lead Thin Shrink Small Outline Package (TSSOP), JEDEC MO-153, 4.4mm Wide
74AC109PC	N16E	16-Lead Plastic Dual-in-Line Package (PDIP), JEDEC MS-001, 0.300" Wide
74ACT109SC	M16A	16-Lead Small Outline Integrated Circuit (SOIC), JEDEC MS-012, 0.150 Narrow
74ACT109MTC	MTC16	16-Lead Thin Shrink Small Outline Package (TSSOP), JEDEC MO-153, 4.4mm Wide
74ACT109PC	N16E	16-Lead Plastic Dual-In-Line Package (PDIP), JEDEC MS-001, 0.300 Wide

Device also available in Tape and Reel. Specify by appending suffix letter "X" to the ordering code.

Connection Diagram

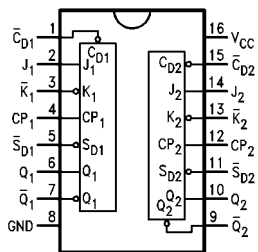

Pin Descriptions

Pin Names	Description
$J_1, J_2, \overline{K}_1, \overline{K}_2$	Data Inputs
CP_1, CP_2	Clock Pulse Inputs
$\overline{C}_D1, \overline{C}_D2$	Direct Clear Inputs
$\overline{S}_D1, \overline{S}_D2$	Direct Set Inputs
$Q_1, Q_2, \overline{Q}_1, \overline{Q}_2$	Outputs

FACT™ is a trademark of Fairchild Semiconductor Corporation.

Logic Symbols

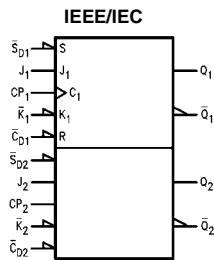
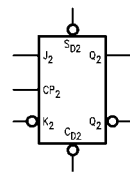
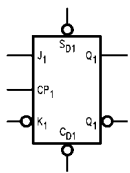

Truth Table

(each half)

Inputs					Outputs	
\bar{S}_D	\bar{C}_D	CP	J	\bar{K}	Q	\bar{Q}
L	H	X	X	X	H	L
H	L	X	X	X	L	H
L	L	X	X	X	H	H
H	H	↗	L	L	L	H
H	H	↗	H	L	Toggle	
H	H	↗	L	H	Q_0	\bar{Q}_0
H	H	↗	H	H	H	L
H	H	L	X	X	Q_0	\bar{Q}_0

H = HIGH Voltage Level
 L = LOW Voltage Level
 ↗ = LOW-to-HIGH Transition
 X = Immaterial

$Q_0(\bar{Q}_0)$ = Previous $Q_0(\bar{Q}_0)$ before LOW-to-HIGH Transition of Clock

Logic Diagram (one half shown)

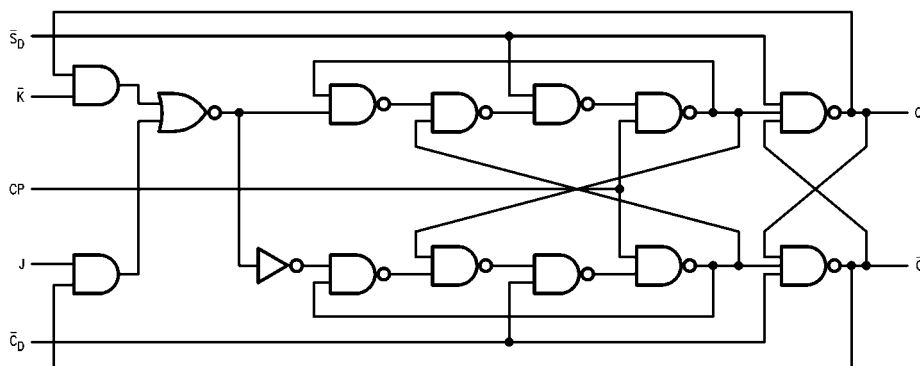

Please note that this diagram is provided only for the understanding of logic operations and should not be used to estimate propagation delays.

Absolute Maximum Ratings(Note 1)

Supply Voltage (V_{CC})	-0.5V to +7.0V
DC Input Diode Current (I_{IK})	
$V_I = -0.5V$	-20 mA
$V_I = V_{CC} + 0.5V$	+20 mA
DC Input Voltage (V_I)	-0.5V to $V_{CC} + 0.5V$
DC Output Diode Current (I_{OK})	
$V_O = -0.5V$	-20 mA
$V_O = V_{CC} + 0.5V$	+20 mA
DC Output Voltage (V_O)	-0.5V to $V_{CC} + 0.5V$
DC Output Source or Sink Current (I_O)	± 50 mA
DC V_{CC} or Ground Current per Output Pin (I_{CC} or I_{GND})	± 50 mA
Storage Temperature (T_{STG})	-65°C to +150°C
Junction Temperature (T_J)	
PDIP	140°C

Recommended Operating Conditions

Supply Voltage (V_{CC})	
AC	2.0V to 6.0V
ACT	4.5V to 5.5V
Input Voltage (V_I)	0V to V_{CC}
Output Voltage (V_O)	0V to V_{CC}
Operating Temperature (T_A)	-40°C to +85°C
Minimum Input Edge Rate ($\Delta V/\Delta t$)	
AC Devices	
V_{IN} from 30% to 70% of V_{CC}	
V_{CC} @ 3.3V, 4.5V, 5.5V	125 mV/ns
Minimum Input Edge Rate ($\Delta V/\Delta t$)	
ACT Devices	
V_{IN} from 0.8V to 2.0V	
V_{CC} @ 4.5V, 5.5V	125 mV/ns

Note 1: Absolute maximum ratings are those values beyond which damage to the device may occur. The databook specifications should be met, with-out exception, to ensure that the system design is reliable over its power supply, temperature, and output/input loading variables. Fairchild does not recommend operation of FACT™ circuits outside databook specifications.

DC Electrical Characteristics for AC

Symbol	Parameter	V_{CC} (V)	$T_A = +25^\circ\text{C}$		$T_A = -40^\circ\text{C to } +85^\circ\text{C}$		Units	Conditions
			Typ	Guaranteed Limits				
V_{IH}	Minimum HIGH Level Input Voltage	3.0	1.5	2.1	2.1	V	$V_{OUT} = 0.1V$ or $V_{CC} - 0.1V$	
		4.5	2.25	3.15	3.15			
		5.5	2.75	3.85	3.85			
V_{IL}	Maximum LOW Level Input Voltage	3.0	1.5	0.9	0.9	V	$V_{OUT} = 0.1V$ or $V_{CC} - 0.1V$	
		4.5	2.25	1.35	1.35			
		5.5	2.75	1.65	1.65			
V_{OH}	Minimum HIGH Level Output Voltage	3.0	2.99	2.9	2.9	V	$I_{OUT} = -50 \mu A$	
		4.5	4.49	4.4	4.4			
		5.5	5.49	5.4	5.4			
			3.0		2.56	2.46	V	$V_{IN} = V_{IL}$ or V_{IH} $I_{OH} = -12$ mA $I_{OH} = -24$ mA $I_{OH} = -24$ mA (Note 2)
			4.5		3.86	3.76		
			5.5		4.86	4.76		
V_{OL}	Maximum LOW Level Output Voltage	3.0	0.002	0.1	0.1	V	$I_{OUT} = 50 \mu A$	
		4.5	0.001	0.1	0.1			
		5.5	0.001	0.1	0.1			
			3.0		0.36	0.44	V	$V_{IN} = V_{IL}$ or V_{IH} $I_{OL} = 12$ mA $I_{OL} = 24$ mA $I_{OL} = 24$ mA (Note 2)
			4.5		0.36	0.44		
			5.5		0.36	0.44		
I_{IN} (Note 4)	Maximum Input Leakage Current	5.5		± 0.1	± 1.0	μA	$V_I = V_{CC}$, GND	
I_{OLD}	Minimum Dynamic	5.5			75	mA	$V_{OLD} = 1.65V$ Max	
I_{OHD}	Output Current (Note 3)	5.5			-75	mA	$V_{OHD} = 3.85V$ Min	
I_{CC} (Note 4)	Maximum Quiescent Supply Current	5.5		2.0	20.0	μA	$V_{IN} = V_{CC}$ or GND	

Note 2: All outputs loaded; thresholds on input associated with output under test.

Note 3: Maximum test duration 2.0 ms, one output loaded at a time.

Note 4: I_{IN} and I_{CC} @ 3.0V are guaranteed to be less than or equal to the respective limit @ 5.5V V_{CC} .

DC Electrical Characteristics for ACT

Symbol	Parameter	V _{CC} (V)	T _A = +25°C		T _A = -40°C to +85°C		Units	Conditions
			Typ	Guaranteed Limits				
V _{IH}	Minimum HIGH Level Input Voltage	4.5	1.5	2.0	2.0	V	V _{OUT} = 0.1V or V _{CC} - 0.1V	
		5.5	1.5	2.0	2.0			
V _{IL}	Maximum LOW Level Input Voltage	4.5	1.5	0.8	0.8	V	V _{OUT} = 0.1V or V _{CC} - 0.1V	
		5.5	1.5	0.8	0.8			
V _{OH}	Minimum HIGH Level Output Voltage	4.5	4.49	4.4	4.4	V	I _{OUT} = -50 μA	
		5.5	5.49	5.4	5.4			
		4.5		3.86	3.76	V	V _{IN} = V _{IL} or V _{IH} I _{OH} = -24 mA I _{OH} = -24 mA (Note 5)	
		5.5		4.86	4.76			
V _{OL}	Maximum LOW Level Output Voltage	4.5	0.001	0.1	0.1	V	I _{OUT} = 50 μA	
		5.5	0.001	0.1	0.1			
		4.5		0.36	0.44	V	V _{IN} = V _{IL} or V _{IH} I _{OL} = 24 mA I _{OL} = 24 mA (Note 5)	
		5.5		0.36	0.44			
I _{IN}	Maximum Input Leakage Current	5.5		± 0.1	± 1.0	μA	FV _I = V _{CC} , GND	
I _{CCT}	Maximum I _{CC} /Input	5.5	0.6		1.5	mA	V _I = V _{CC} - 2.1V	
I _{OLD}	Minimum Dynamic	5.5			75	mA	V _{OLD} = 1.65V Max	
I _{OHD}	Output Current (Note 6)	5.5			-75	mA	V _{OHD} = 3.85V Min	
I _{CC}	Maximum Quiescent Supply Current	5.5		2.0	20.0	μA	V _{IN} = V _{CC} or GND	

Note 5: All outputs loaded; thresholds on input associated with output under test.

Note 6: Maximum test duration 2.0 ms, one output loaded at a time.

AC Electrical Characteristics for AC

Symbol	Parameter	V _{CC} (V) (Note 7)	T _A = +25°C C _L = 50 pF			T _A = -40°C to +85°C C _L = 50 pF		Units
			Min	Typ	Max	Min	Max	
f _{MAX}	Maximum Clock Frequency	3.3	125	150		100	MHz	
		5.0	150	175		125		
t _{PLH}	Propagation Delay C _{Pn} to Q _n or \bar{Q}_n	3.3	4.0	8.0	13.5	3.5	16.0	ns
		5.0	2.5	6.0	10.0	2.0	10.5	
t _{PHL}	Propagation Delay C _{Pn} to Q _n or \bar{Q}_n	3.3	3.0	8.0	14.0	3.0	14.5	ns
		5.0	2.0	6.0	10.0	1.5	10.5	
t _{PLH}	Propagation Delay \bar{C}_{Dn} or \bar{S}_{Dn} to Q _n or \bar{Q}_n	3.3	3.0	8.0	12.0	2.5	13.0	ns
		5.0	2.5	6.0	9.0	2.0	10.0	
t _{PHL}	Propagation Delay \bar{C}_{Dn} or \bar{S}_{Dn} to Q _n or \bar{Q}_n	3.3	3.0	10.0	12.0	3.0	13.5	ns
		5.0	2.0	7.5	9.5	2.0	10.5	

Note 7: Voltage Range 3.3 is 3.3V ± 0.3V

Voltage Range 5.0 is 5.0V ± 0.5V

AC Operating Requirements for AC								
Symbol	Parameter	V _{CC} (V) (Note 8)	T _A = +25°C C _L = 50 pF		T _A = -40°C to +85°C C _L = 50 pF		Units	
			Typ	Guaranteed Minimum				
t _S	Setup Time, HIGH or LOW J _n or \overline{K}_n to CP _n	3.3	3.5	6.5	7.5		ns	
		5.0	2.0	4.5	5.0			
t _H	Hold Time, HIGH or LOW J _n or \overline{K}_n to CP _n	3.3	-1.5	0	0		ns	
		5.0	-0.5	0.5	0.5			
t _W	Pulse Width \overline{C}_{Dn} or \overline{S}_{Dn}	3.3	2.0	7.0	7.5		ns	
		5.0	2.0	4.5	5.0			
t _{REC}	Recovery Time \overline{C}_{Dn} or \overline{S}_{Dn} to CP _n	3.3	-2.5	0	0		ns	
		5.0	-1.5	0	0			
Note 8: Voltage Range 3.3 is 3.3V ± 0.3V Voltage Range 5.0 is 5.0V ± 0.5V								
AC Electrical Characteristics for ACT								
Symbol	Parameter	V _{CC} (V) (Note 9)	T _A = +25°C C _L = 50 pF			T _A = -40°C to +85°C C _L = 50 pF		Units
			Min	Typ	Max	Min	Max	
f _{MAX}	Maximum Clock Frequency	5.0	145	210	125		MHz	
t _{PLH}	Propagation Delay CP _n to Q _n or \overline{Q}_n	5.0	4.0	7.0	11.0	3.5	13.0	ns
t _{PHL}	Propagation Delay CP _n to Q _n or \overline{Q}_n	5.0	3.0	6.0	10.0	2.5	11.5	ns
t _{PLH}	Propagation Delay \overline{C}_{Dn} or \overline{S}_{Dn} to Q _n or \overline{Q}_n	5.0	2.5	5.5	9.5	2.0	10.5	ns
t _{PHL}	Propagation Delay \overline{C}_{Dn} or \overline{S}_{Dn} to Q _n or \overline{Q}_n	5.0	2.5	6.0	10.0	2.0	11.5	ns
Note 9: Voltage Range 5.0 is 5.0V ± 0.5V								
AC Operating Requirements for ACT								
Symbol	Parameter	V _{CC} (V) (Note 10)	T _A = +25°C C _L = 50 pF		T _A = -40°C to +85°C C _L = 50 pF		Units	
			Typ	Guaranteed Minimum				
t _S	Setup Time, HIGH or LOW J _n or \overline{K}_n to CP _n	5.0	0.5	2.0	2.5		ns	
t _H	Hold Time, HIGH or LOW J _n or \overline{K}_n to CP _n	5.0	0	2.0	2.0		ns	
t _W	Pulse Width CP _n or \overline{C}_{Dn} or \overline{S}_{Dn}	5.0	3.0	5.0	6.0		ns	
t _{rec}	Recovery Time \overline{C}_{Dn} or \overline{S}_{Dn} to CP _n	5.0	-2.5	0	0		ns	
Note 10: Voltage Range 5.0 is 5.0V ± 0.5V								
Capacitance								
Symbol	Parameter	Typ	Units	Conditions				
C _{IN}	Input Capacitance	4.5	pF	V _{CC} = OPEN				
C _{PD}	Power Dissipation Capacitance	35.0	pF	V _{CC} = 5.0V				

Physical Dimensions inches (millimeters) unless otherwise noted



**16-Lead Small Outline Integrated Circuit (SOIC), JEDEC MS-012, 0.150 Narrow
Package Number M16A**

Physical Dimensions inches (millimeters) unless otherwise noted (Continued)

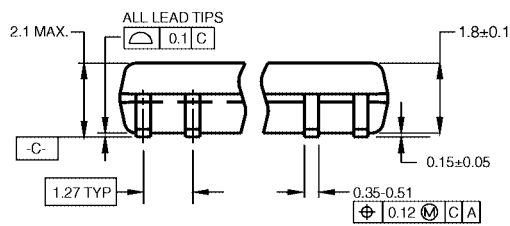
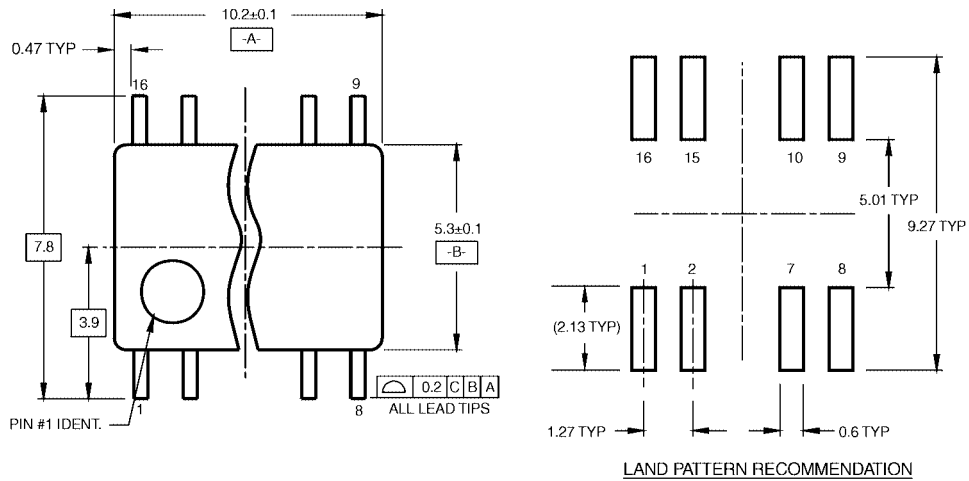

DIMENSIONS ARE IN MILLIMETERS

NOTES:

- A. CONFORMS TO EIAJ EDR-7320 REGISTRATION, ESTABLISHED IN DECEMBER, 1998.
- B. DIMENSIONS ARE IN MILLIMETERS.
- C. DIMENSIONS ARE EXCLUSIVE OF BURRS, MOLD FLASH, AND TIE BAR EXTRUSIONS.

M16DRevB1



**16-Lead Small Outline Package (SOP), EIAJ TYPE II, 5.3mm Wide
Package Number M16D**

Physical Dimensions inches (millimeters) unless otherwise noted (Continued)

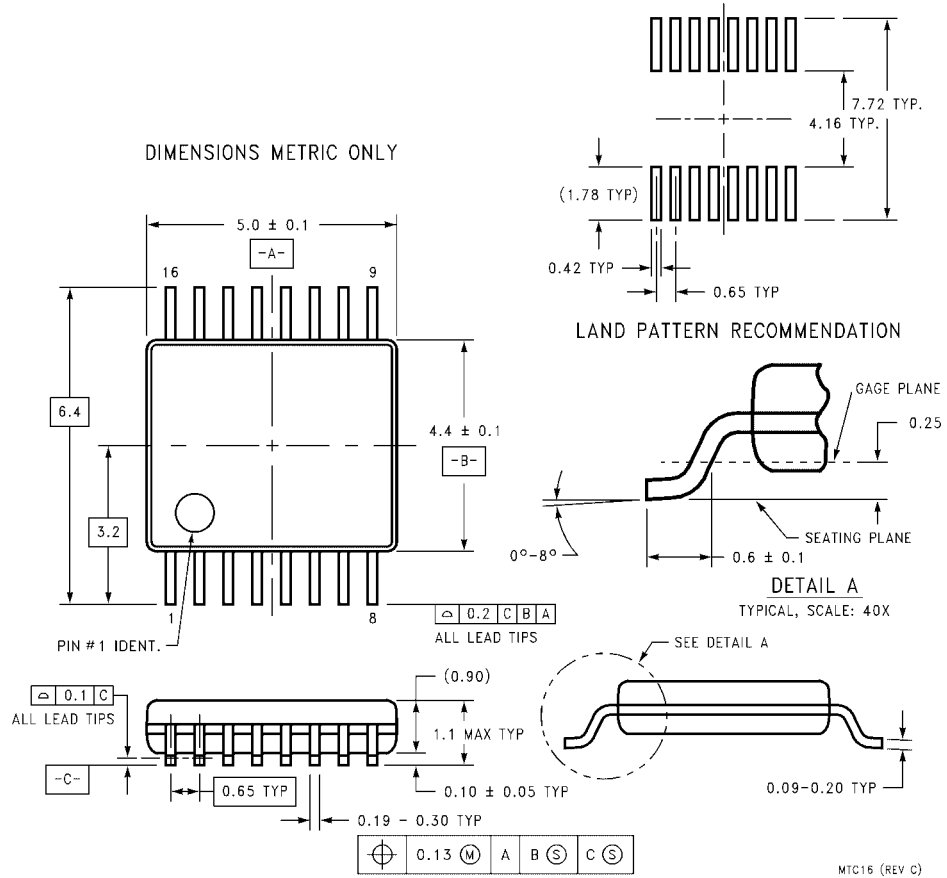

**16-Lead Thin Shrink Small Outline Package (TSSOP), JEDEC MO-153, 4.4mm Wide
Package Number MTC16**

Physical Dimensions inches (millimeters) unless otherwise noted (Continued)



16-Lead Plastic Dual-In-Line Package (PDIP), JEDEC MS-001, 0.300 Wide Package Number N16E

Fairchild does not assume any responsibility for use of any circuitry described, no circuit patent licenses are implied and Fairchild reserves the right at any time without notice to change said circuitry and specifications.

LIFE SUPPORT POLICY

FAIRCHILD'S PRODUCTS ARE NOT AUTHORIZED FOR USE AS CRITICAL COMPONENTS IN LIFE SUPPORT DEVICES OR SYSTEMS WITHOUT THE EXPRESS WRITTEN APPROVAL OF THE PRESIDENT OF FAIRCHILD SEMICONDUCTOR CORPORATION. As used herein:

1. Life support devices or systems are devices or systems which, (a) are intended for surgical implant into the body, or (b) support or sustain life, and (c) whose failure to perform when properly used in accordance with instructions for use provided in the labeling, can be reasonably expected to result in a significant injury to the user.
2. A critical component in any component of a life support device or system whose failure to perform can be reasonably expected to cause the failure of the life support device or system, or to affect its safety or effectiveness.

www.fairchildsemi.com