

# DATA SHEET

## **BF545A; BF545B; BF545C** N-channel silicon junction field-effect transistors

Product specification  
Supersedes data of April 1995  
File under Discrete Semiconductors, SC07

1996 Jul 29

# N-channel silicon junction field-effect transistors

## BF545A; BF545B; BF545C

### FEATURES

- Low leakage level (typ. 500 fA)
- High gain
- Low cut-off voltage (max. 2.2 V for BF545A).

### APPLICATIONS

- Impedance converters in e.g. electret microphones and infra-red detectors
- VHF amplifiers in oscillators and mixers.

### DESCRIPTION

N-channel symmetrical silicon junction field-effect transistors in a SOT23 package.

### PINNING - SOT23

PIN	SYMBOL	DESCRIPTION
1	s	source
2	d	drain
3	g	gate

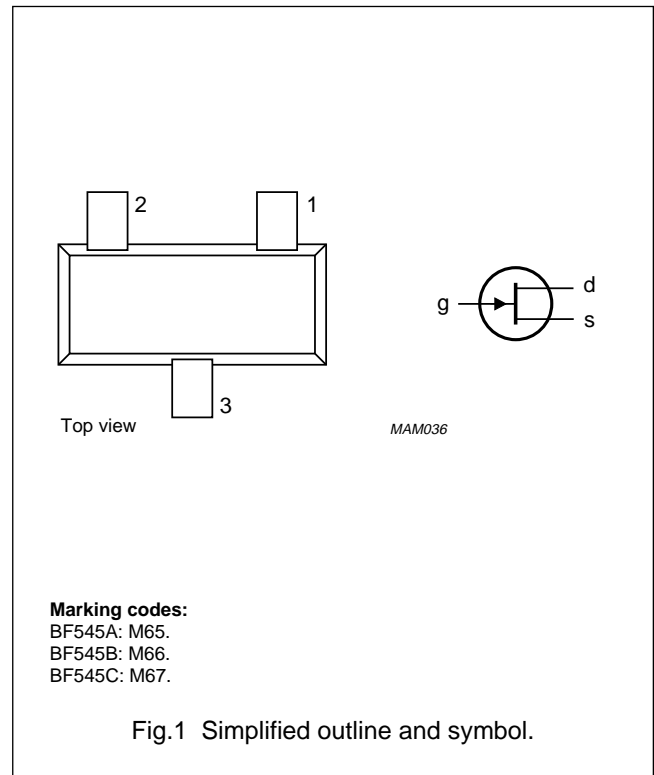

### QUICK REFERENCE DATA

SYMBOL	PARAMETER	CONDITIONS	MIN.	MAX.	UNIT
$V_{DS}$	drain-source voltage		–	±30	V
$V_{GSoff}$	gate-source cut-off voltage	$I_D = 1 \mu A; V_{DS} = 15 V$	–0.4	–7.8	V
$I_{DSS}$	drain current BF545A BF545B BF545C	$V_{GS} = 0; V_{DS} = 15 V$	2 6 12	6.5 15 25	mA mA mA
$P_{tot}$	total power dissipation	up to $T_{amb} = 25 \text{ }^\circ C$	–	250	mW
$ y_{fs} $	forward transfer admittance	$V_{GS} = 0; V_{DS} = 15 V$	3	6.5	mS

N-channel silicon junction  
field-effect transistors

BF545A; BF545B; BF545C

**LIMITING VALUES**

In accordance with the Absolute Maximum Rating System (IEC 134).

SYMBOL	PARAMETER	CONDITIONS	MIN.	MAX.	UNIT
$V_{DS}$	drain-source voltage		–	$\pm 30$	V
$V_{GSO}$	gate-source voltage	open drain	–	–30	V
$V_{GDO}$	gate-drain voltage (DC)	open source	–	–30	V
$I_G$	forward gate current (DC)		–	10	mA
$P_{tot}$	total power dissipation	up to $T_{amb} = 25\text{ }^\circ\text{C}$ ; note 1	–	250	mW
$T_{stg}$	storage temperature		–65	150	$^\circ\text{C}$
$T_j$	operating junction temperature		–	150	$^\circ\text{C}$

**Note**

1. Device mounted on an FR4 printed-circuit board, maximum lead length 4 mm; mounting pad for the drain lead 10 mm<sup>2</sup>.

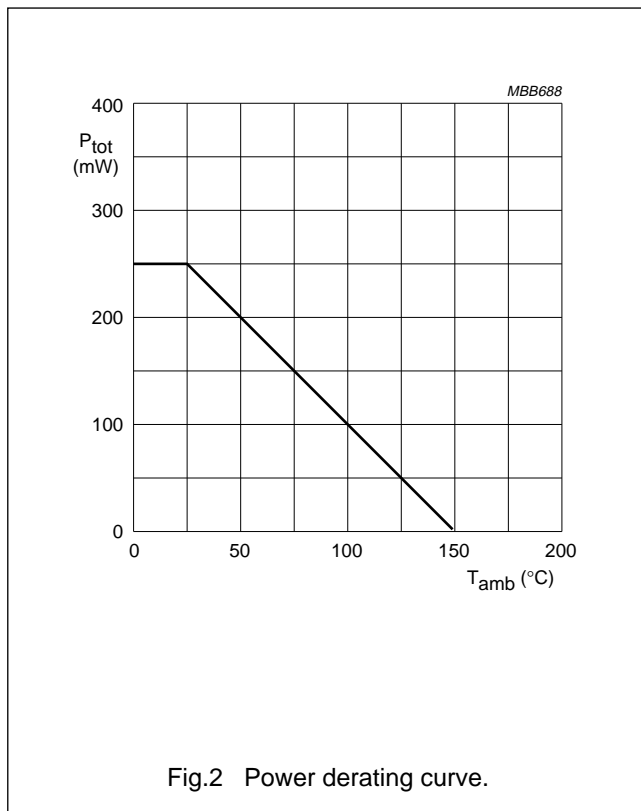

## N-channel silicon junction field-effect transistors

## BF545A; BF545B; BF545C

### THERMAL CHARACTERISTICS

SYMBOL	PARAMETER	VALUE	UNIT
$R_{th\ j-a}$	thermal resistance from junction to ambient; note 1	500	K/W

#### Note

- Device mounted on an FR4 printed-circuit board, maximum lead length 4 mm; mounting pad for the drain lead 10 mm<sup>2</sup>.

### STATIC CHARACTERISTICS

$T_j = 25\text{ °C}$ ; unless otherwise specified.

SYMBOL	PARAMETER	CONDITIONS	MIN.	TYP.	MAX.	UNIT	
$V_{(BR)GSS}$	gate-source breakdown voltage	$I_G = -1\ \mu\text{A}; V_{DS} = 0$	-30	-	-	V	
$V_{GSoff}$	gate-source cut-off voltage	$I_D = 200\ \mu\text{A}; V_{DS} = 15\ \text{V}$	BF545A	-0.4	-	-2.2	V
			BF545B	-1.6	-	-3.8	V
			BF545C	-3.2	-	-7.8	V
		$I_D = 1\ \mu\text{A}; V_{DS} = 15\ \text{V}$	-0.4	-	-7.5	V	
$I_{DSS}$	drain current	$V_{GS} = 0; V_{DS} = 15\ \text{V}$	BF545A	2	-	6.5	mA
			BF545B	6	-	15	mA
			BF545C	12	-	25	mA
$I_{GSS}$	gate leakage current	$V_{GS} = -20\ \text{V}; V_{DS} = 0$	-	-0.5	-1000	pA	
		$V_{GS} = -20\ \text{V}; V_{DS} = 0;$ $T_j = 125\text{ °C}$	-	-	-100	nA	
$ y_{fs} $	forward transfer admittance	$V_{GS} = 0; V_{DS} = 15\ \text{V}$	3	-	6.5	mS	
$ y_{os} $	common source output admittance	$V_{GS} = 0; V_{DS} = 15\ \text{V}$	-	40	-	$\mu\text{S}$	

N-channel silicon junction field-effect transistors

BF545A; BF545B; BF545C

**DYNAMIC CHARACTERISTICS**

$T_{amb} = 25\text{ }^{\circ}\text{C}$ ; unless otherwise specified.

SYMBOL	PARAMETER	CONDITIONS	TYP.	UNIT
$C_{is}$	input capacitance	$V_{DS} = 15\text{ V}; V_{GS} = -10\text{ V}; f = 1\text{ MHz}$	1.7	pF
		$V_{DS} = 15\text{ V}; V_{GS} = 0; f = 1\text{ MHz}$	3	pF
$C_{rs}$	reverse transfer capacitance	$V_{DS} = 15\text{ V}; V_{GS} = -10\text{ V}; f = 1\text{ MHz}$	0.8	pF
		$V_{DS} = 15\text{ V}; V_{GS} = 0; f = 1\text{ MHz}$	0.9	pF
$g_{is}$	common source input conductance	$V_{DS} = 10\text{ V}; I_D = 1\text{ mA}; f = 100\text{ MHz}$	15	$\mu\text{S}$
		$V_{DS} = 10\text{ V}; I_D = 1\text{ mA}; f = 450\text{ MHz}$	300	$\mu\text{S}$
$g_{fs}$	common source transfer conductance	$V_{DS} = 10\text{ V}; I_D = 1\text{ mA}; f = 100\text{ MHz}$	2	mS
		$V_{DS} = 10\text{ V}; I_D = 1\text{ mA}; f = 450\text{ MHz}$	1.8	mS
$g_{rs}$	common source reverse conductance	$V_{DS} = 10\text{ V}; I_D = 1\text{ mA}; f = 100\text{ MHz}$	-6	$\mu\text{S}$
		$V_{DS} = 10\text{ V}; I_D = 1\text{ mA}; f = 450\text{ MHz}$	-40	$\mu\text{S}$
$g_{os}$	common source output conductance	$V_{DS} = 10\text{ V}; I_D = 1\text{ mA}; f = 100\text{ MHz}$	30	$\mu\text{S}$
		$V_{DS} = 10\text{ V}; I_D = 1\text{ mA}; f = 450\text{ MHz}$	60	$\mu\text{S}$

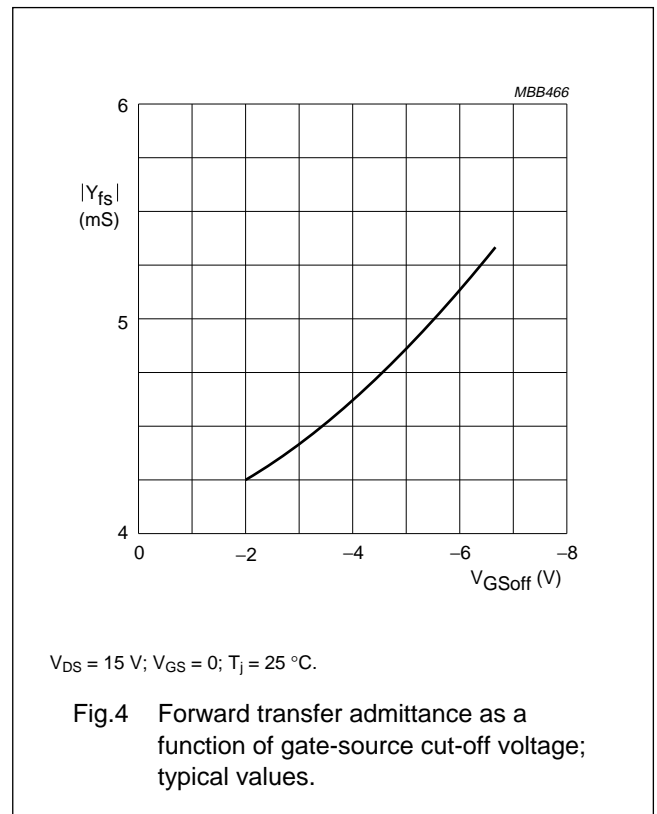
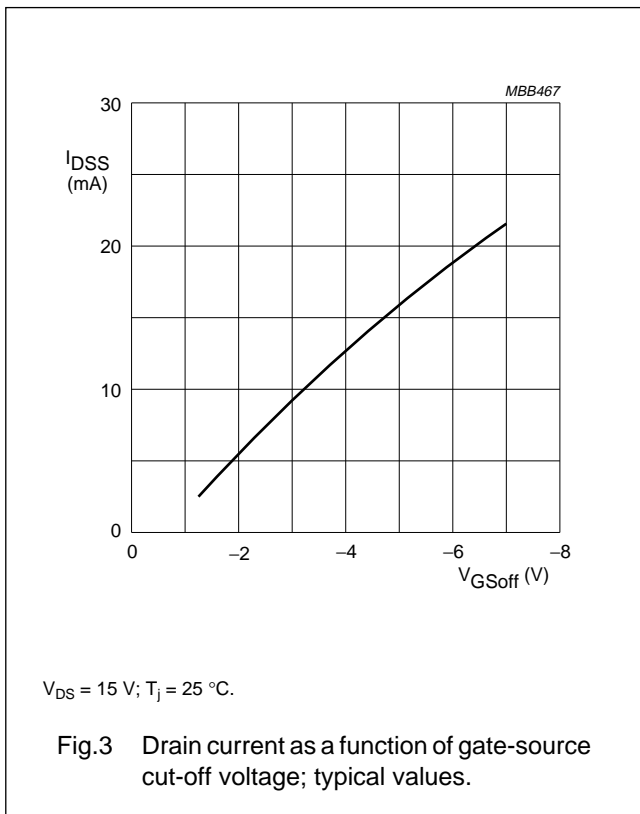

N-channel silicon junction field-effect transistors

BF545A; BF545B; BF545C

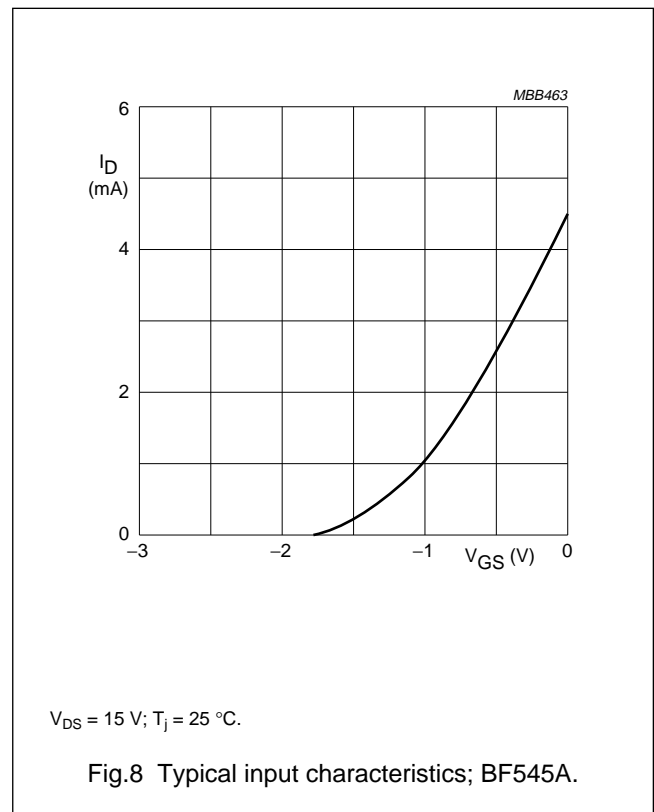
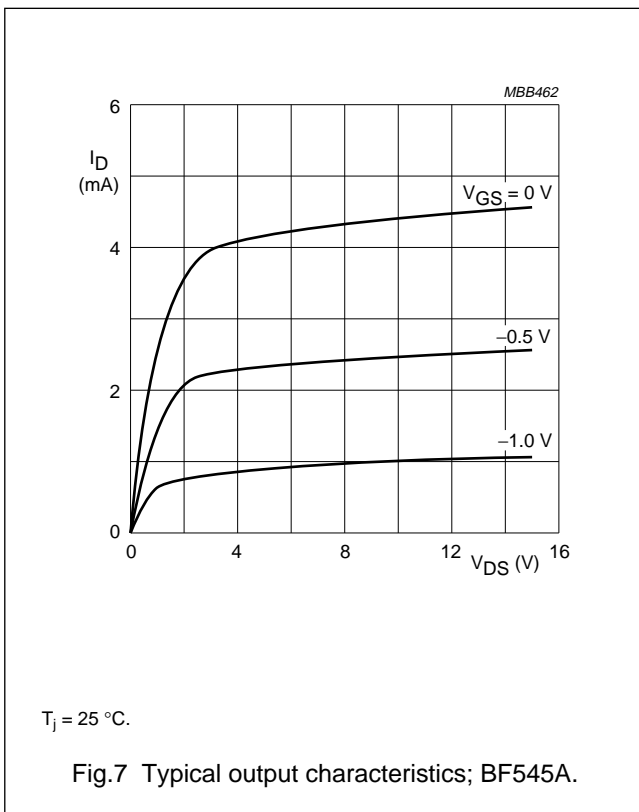
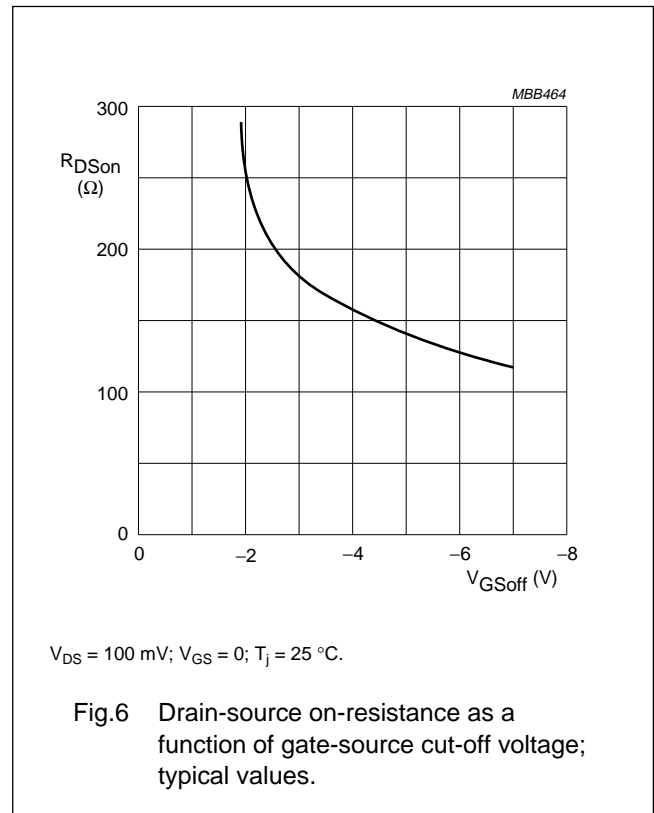
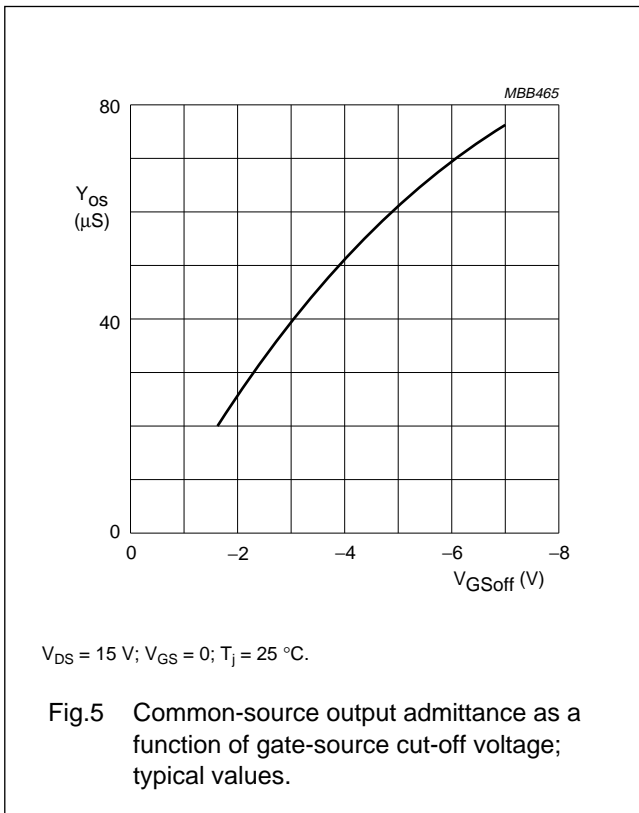

N-channel silicon junction field-effect transistors

BF545A; BF545B; BF545C

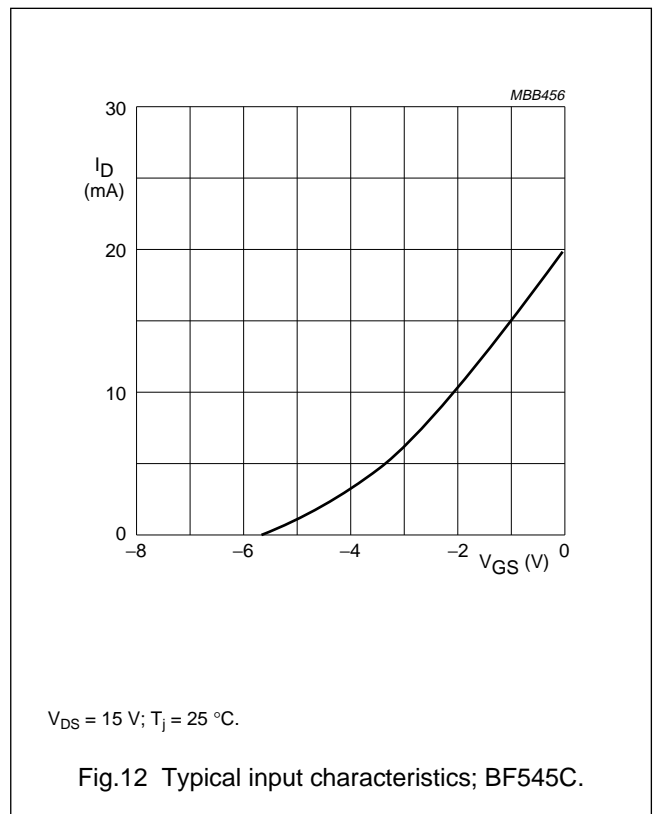
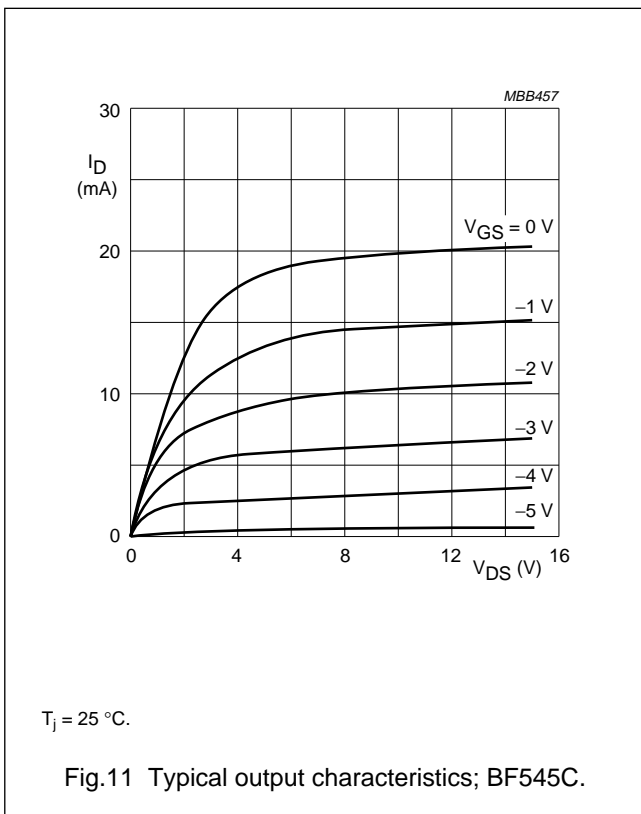
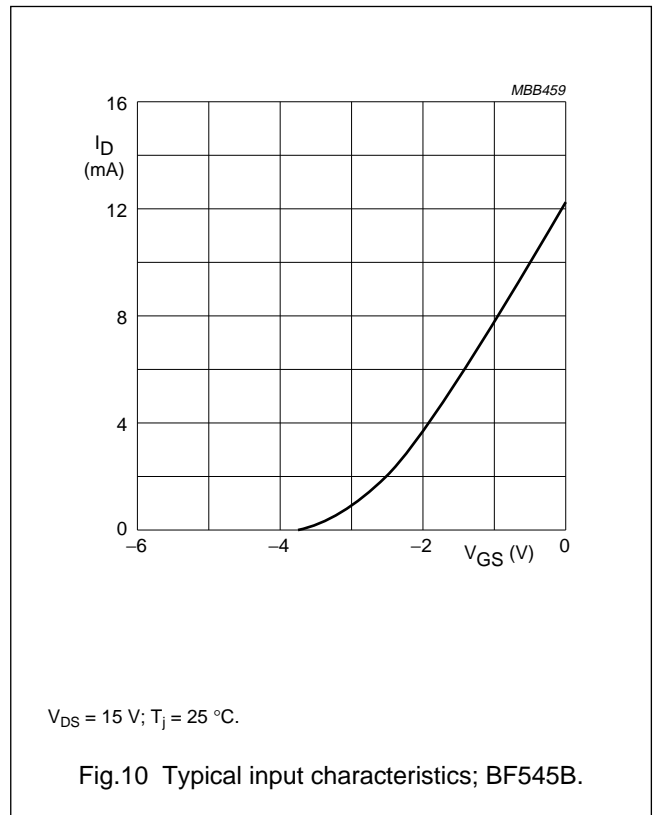
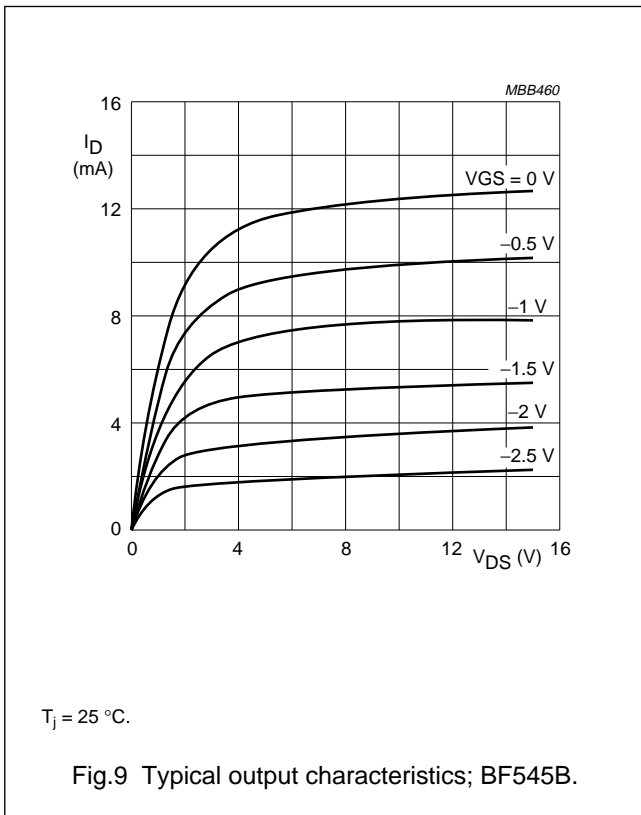

N-channel silicon junction field-effect transistors

BF545A; BF545B; BF545C

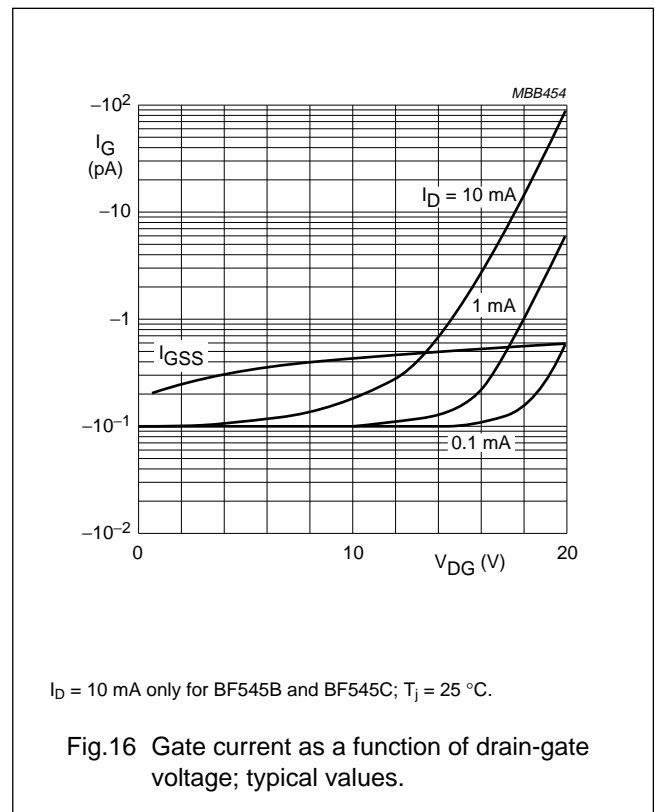
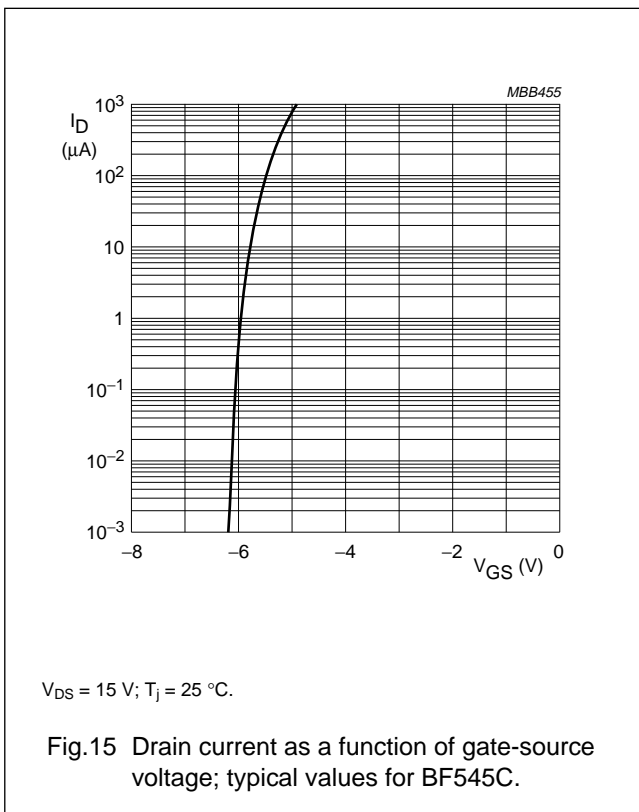
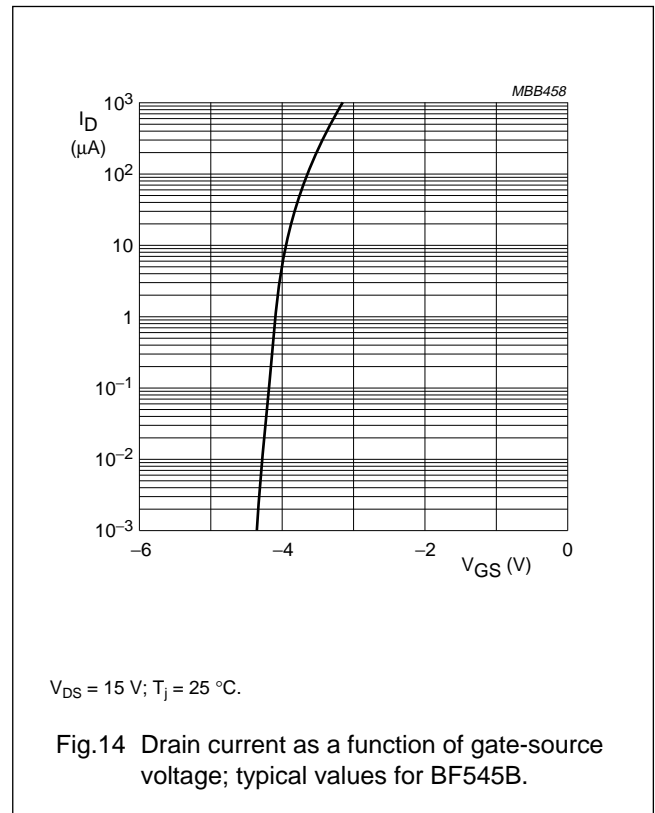
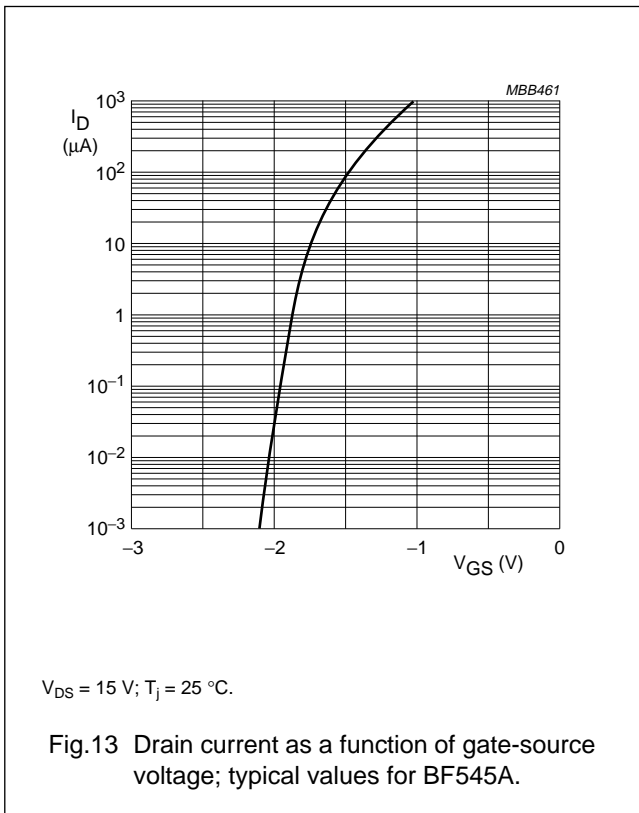



N-channel silicon junction  
field-effect transistors

BF545A; BF545B; BF545C

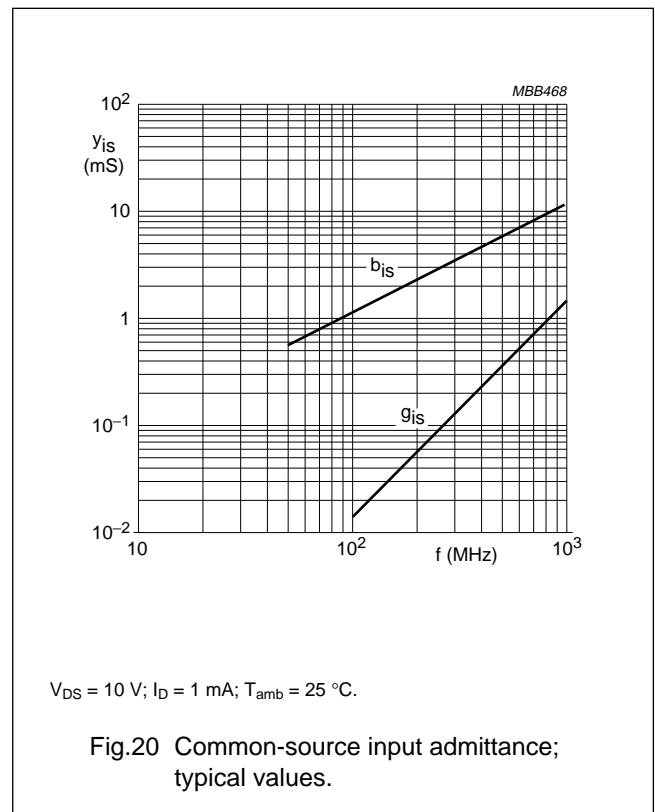
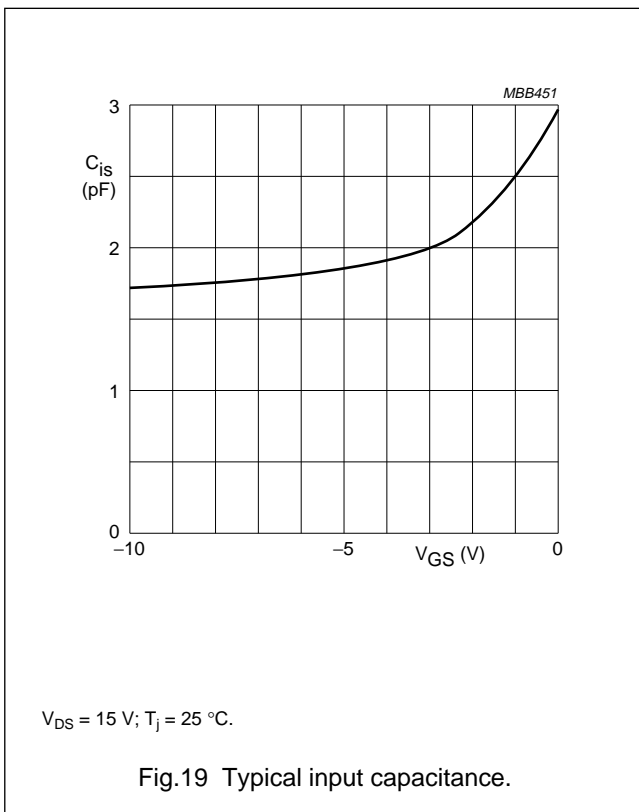
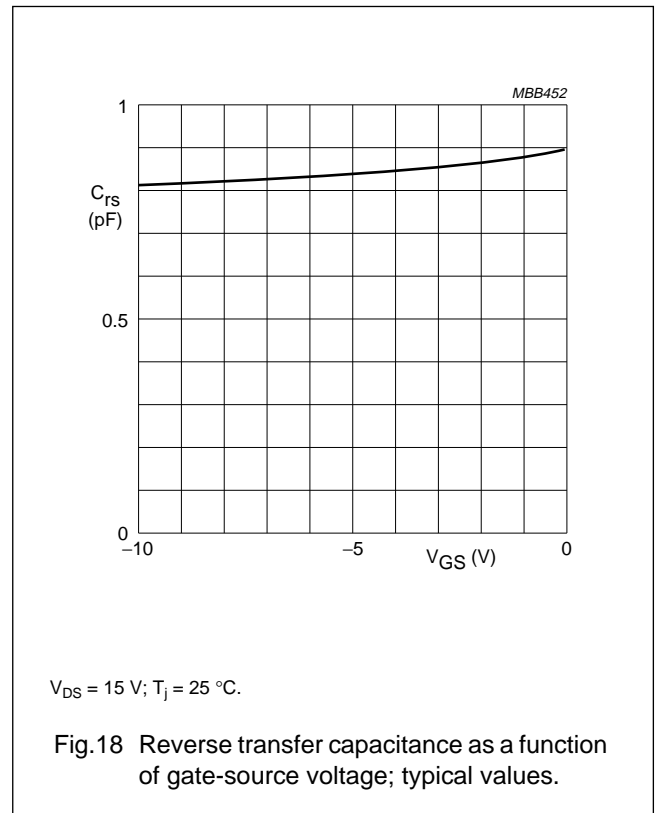
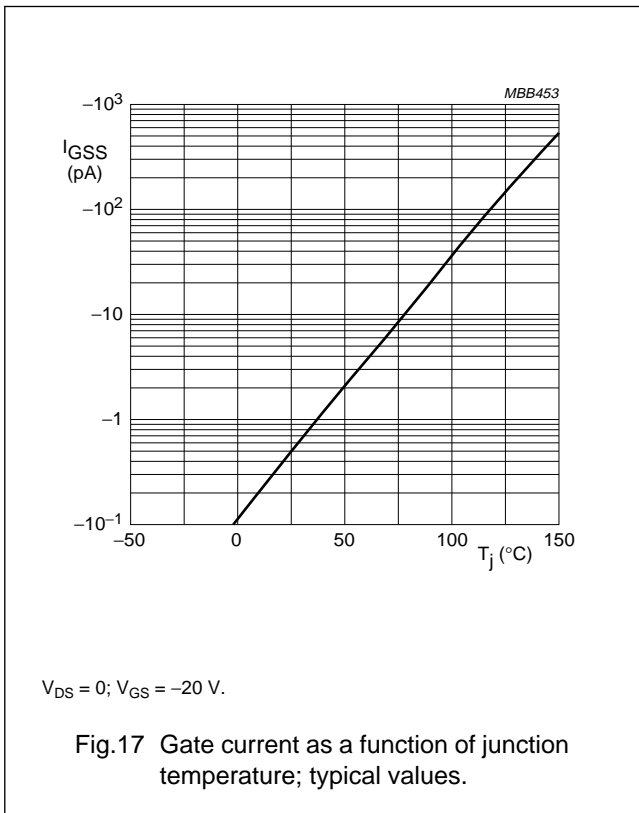

N-channel silicon junction  
field-effect transistors

BF545A; BF545B; BF545C

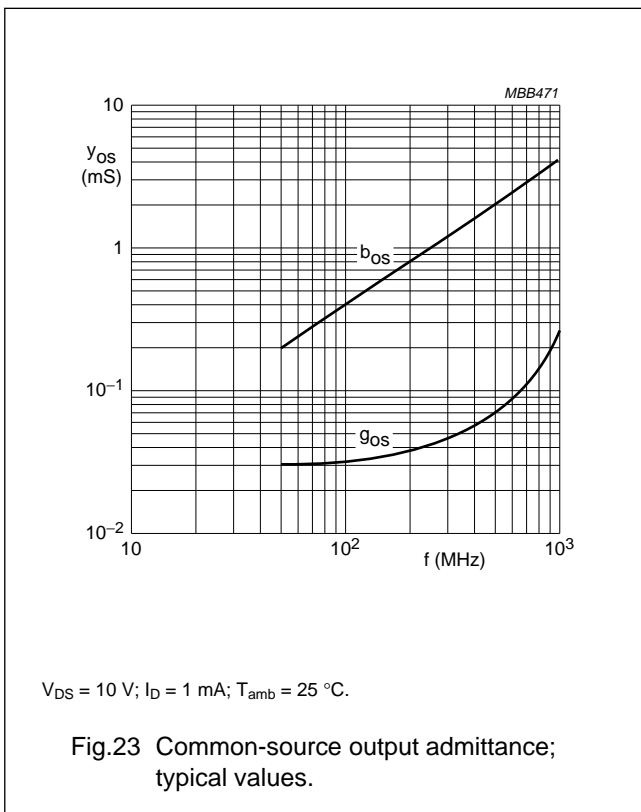
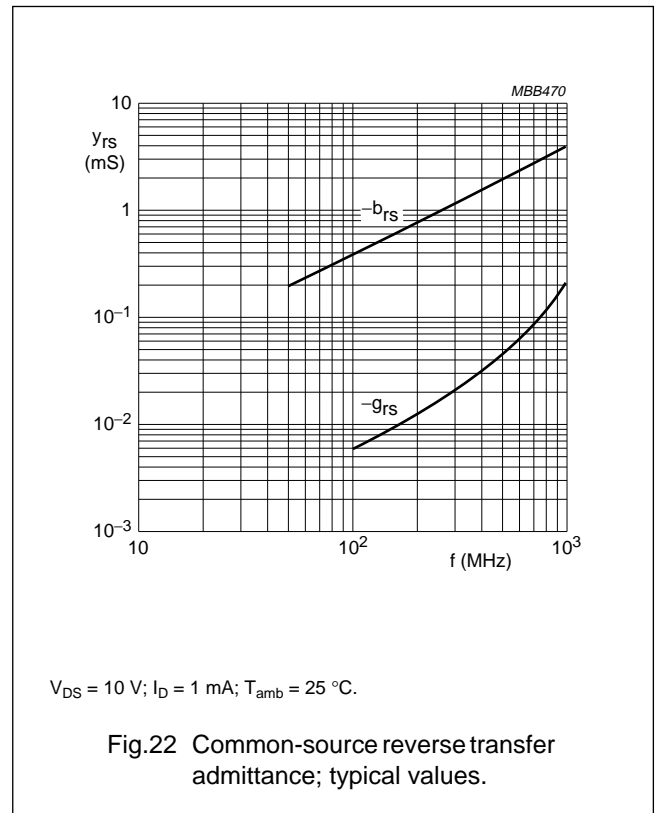
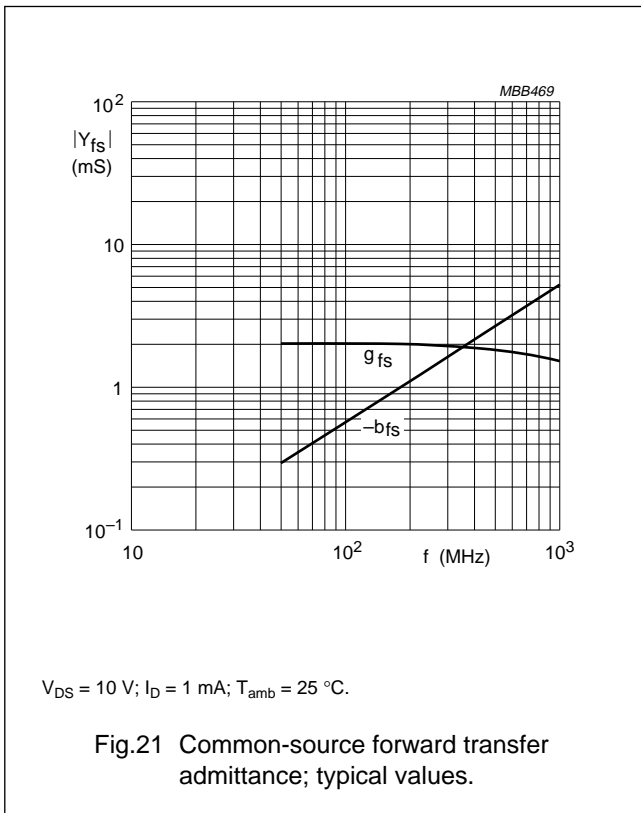



## N-channel silicon junction field-effect transistors

BF545A; BF545B; BF545C

### DEFINITIONS

<b>Data Sheet Status</b>	
Objective specification	This data sheet contains target or goal specifications for product development.
Preliminary specification	This data sheet contains preliminary data; supplementary data may be published later.
Product specification	This data sheet contains final product specifications.
<b>Limiting values</b>	
Limiting values given are in accordance with the Absolute Maximum Rating System (IEC 134). Stress above one or more of the limiting values may cause permanent damage to the device. These are stress ratings only and operation of the device at these or at any other conditions above those given in the Characteristics sections of the specification is not implied. Exposure to limiting values for extended periods may affect device reliability.	
<b>Application information</b>	
Where application information is given, it is advisory and does not form part of the specification.	

### LIFE SUPPORT APPLICATIONS

These products are not designed for use in life support appliances, devices, or systems where malfunction of these products can reasonably be expected to result in personal injury. Philips customers using or selling these products for use in such applications do so at their own risk and agree to fully indemnify Philips for any damages resulting from such improper use or sale.