

KR12W (1.0)

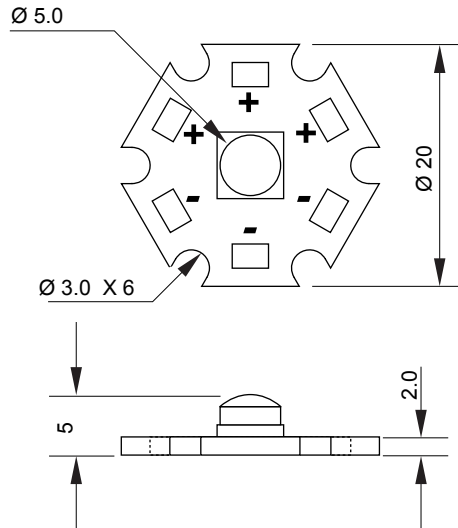

Absolute Maximum Rating at (Ta=25°C)

Parameter	Symbol	Maximum Rating	Unit
Power Dissipation	Pd	1	W
Forward Current	If	270	mA
Forward Voltage	Vr	3.6	V
Operating Temperature Range	Topr	- 40 °C to + 85 °C	
Storage Temperature Range	Tstg	- 40 °C to + 85 °C	
Solder Temperature 1/16 Inch Below Seating Plane for 3 seconds at 260°C			

* Condition for Ifp is pulse of 1/10 Duty Cycle, 0.1ms Pulse Width

Electrical/Optical Characteristics at Ta=25°C

Parameter	Symbol	Condition	Min	Typ	Max	Unit
Forward Voltage	Vf	If=20mA	3.0		3.6	V
Reverse Current	Ir	Vr=5V			100	uA
Dominant Wavelength	λ_d	If=20mA				nm
Peak Wavelength	λ_p	If=20mA				nm
Viewing Angle	2 θ 1/2	If=20mA		120		dfg