

Low Noise Transistors

NPN Silicon

BC549B,C
BC550B,C

MAXIMUM RATINGS

Rating	Symbol	BC549	BC550	Unit
Collector–Emitter Voltage	V_{CEO}	30	45	Vdc
Collector–Base Voltage	V_{CBO}	30	50	Vdc
Emitter–Base Voltage	V_{EBO}	5.0		Vdc
Collector Current — Continuous	I_C	100		mAdc
Total Device Dissipation @ $T_A = 25^\circ\text{C}$ Derate above 25°C	P_D	625	5.0	mW mW/ $^\circ\text{C}$
Total Device Dissipation @ $T_C = 25^\circ\text{C}$ Derate above 25°C	P_D	1.5	12	Watt mW/ $^\circ\text{C}$
Operating and Storage Junction Temperature Range	T_J, T_{stg}	–55 to +150		$^\circ\text{C}$

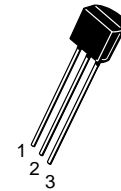

CASE 29–04, STYLE 17
TO–92 (TO–226AA)

THERMAL CHARACTERISTICS

Characteristic	Symbol	Max	Unit
Thermal Resistance, Junction to Ambient	$R_{\theta JA}$	200	$^\circ\text{C}/\text{W}$
Thermal Resistance, Junction to Case	$R_{\theta JC}$	83.3	$^\circ\text{C}/\text{W}$

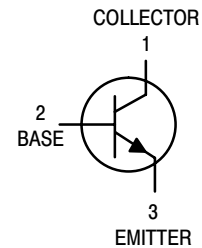

ELECTRICAL CHARACTERISTICS ($T_A = 25^\circ\text{C}$ unless otherwise noted)

Characteristic	Symbol	Min	Typ	Max	Unit
----------------	--------	-----	-----	-----	------

OFF CHARACTERISTICS

Collector–Emitter Breakdown Voltage ($I_C = 10 \text{ mAdc}, I_B = 0$)	BC549B,C BC550B,C	$V_{(BR)CEO}$	30 45	— —	— —	Vdc
Collector–Base Breakdown Voltage ($I_C = 10 \mu\text{Adc}, I_E = 0$)	BC549B,C BC550B,C	$V_{(BR)CBO}$	30 50	— —	— —	Vdc
Emitter–Base Breakdown Voltage ($I_E = 10 \mu\text{Adc}, I_C = 0$)		$V_{(BR)EBO}$	5.0	—	—	Vdc
Collector Cutoff Current ($V_{CB} = 30 \text{ V}, I_E = 0$) ($V_{CB} = 30 \text{ V}, I_E = 0, T_A = +125^\circ\text{C}$)		I_{CBO}	— —	— —	15 5.0	nAdc μAdc
Emitter Cutoff Current ($V_{EB} = 4.0 \text{ Vdc}, I_C = 0$)		I_{EBO}	—	—	15	nAdc

BC549B,C BC550B,C

ELECTRICAL CHARACTERISTICS ($T_A = 25^\circ\text{C}$ unless otherwise noted) (Continued)

Characteristic	Symbol	Min	Typ	Max	Unit
ON CHARACTERISTICS					
DC Current Gain ($I_C = 10 \mu\text{A}$, $V_{CE} = 5.0 \text{ Vdc}$)	h_{FE}	100	150	—	—
BC549B/550B		100	270	—	—
($I_C = 2.0 \text{ mA}$, $V_{CE} = 5.0 \text{ Vdc}$)		200	290	450	—
BC549B/550B		420	500	800	—
BC549C/550C					
Collector–Emitter Saturation Voltage ($I_C = 10 \text{ mA}$, $I_B = 0.5 \text{ mA}$)	$V_{CE(sat)}$	—	0.075	0.25	Vdc
($I_C = 10 \text{ mA}$, $I_B = \text{see note 1}$)		—	0.3	0.6	
($I_C = 100 \text{ mA}$, $I_B = 5.0 \text{ mA}$, see note 2)		—	0.25	0.6	
Base–Emitter Saturation Voltage ($I_C = 100 \text{ mA}$, $I_B = 5.0 \text{ mA}$)	$V_{BE(sat)}$	—	1.1	—	Vdc
Base–Emitter On Voltage ($I_C = 10 \mu\text{A}$, $V_{CE} = 5.0 \text{ Vdc}$)	$V_{BE(on)}$	—	0.52	—	Vdc
($I_C = 100 \mu\text{A}$, $V_{CE} = 5.0 \text{ Vdc}$)		—	0.55	—	
($I_C = 2.0 \text{ mA}$, $V_{CE} = 5.0 \text{ Vdc}$)		0.55	0.62	0.7	

SMALL–SIGNAL CHARACTERISTICS

Current–Gain — Bandwidth Product ($I_C = 10 \text{ mA}$, $V_{CE} = 5.0 \text{ Vdc}$, $f = 100 \text{ MHz}$)	f_T	—	250	—	MHz
Collector–Base Capacitance ($V_{CB} = 10 \text{ Vdc}$, $I_E = 0$, $f = 1.0 \text{ MHz}$)	C_{cbo}	—	2.5	—	pF
Small–Signal Current Gain ($I_C = 2.0 \text{ mA}$, $V_{CE} = 5.0 \text{ V}$, $f = 1.0 \text{ kHz}$)	h_{fe}	240	330	500	—
BC549B/BC550B		450	600	900	—
BC549C/BC550C					
Noise Figure ($I_C = 200 \mu\text{A}$, $V_{CE} = 5.0 \text{ Vdc}$, $R_S = 2.0 \text{ k}\Omega$, $f = 1.0 \text{ kHz}$)	NF_1	—	0.6	2.5	dB
($I_C = 200 \mu\text{A}$, $V_{CE} = 5.0 \text{ Vdc}$, $R_S = 100 \text{ k}\Omega$, $f = 1.0 \text{ kHz}$)	NF_2	—	—	10	

NOTES:

- I_B is value for which $I_C = 11 \text{ mA}$ at $V_{CE} = 1.0 \text{ V}$.
- Pulse test = $300 \mu\text{s}$ – Duty cycle = 2%.

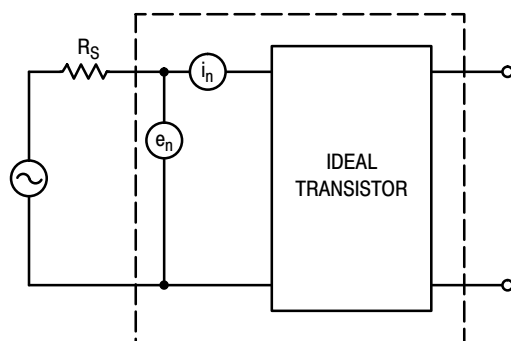

Figure 1. Transistor Noise Model

BC549B,C BC550B,C

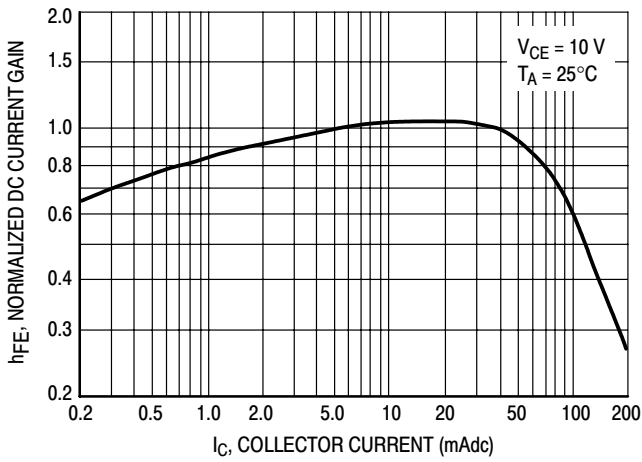

Figure 2. Normalized DC Current Gain

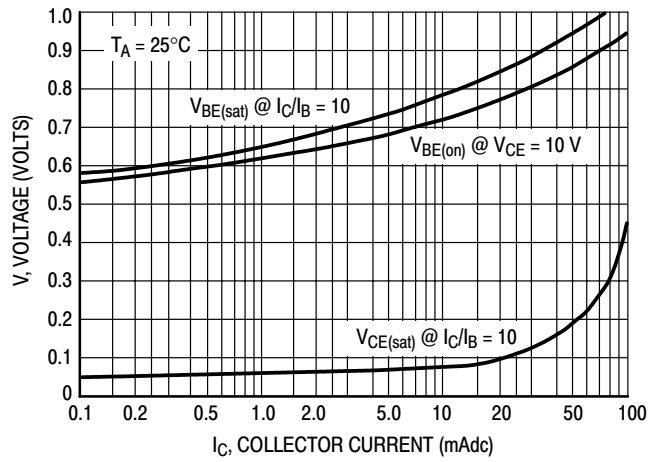

Figure 3. "Saturation" and "On" Voltages

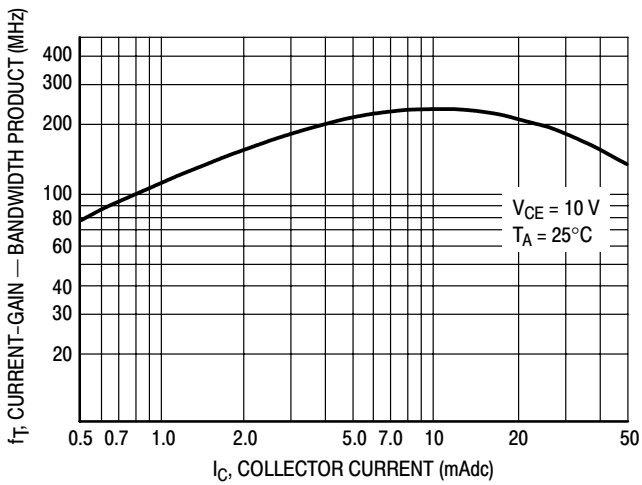

Figure 4. Current-Gain — Bandwidth Product

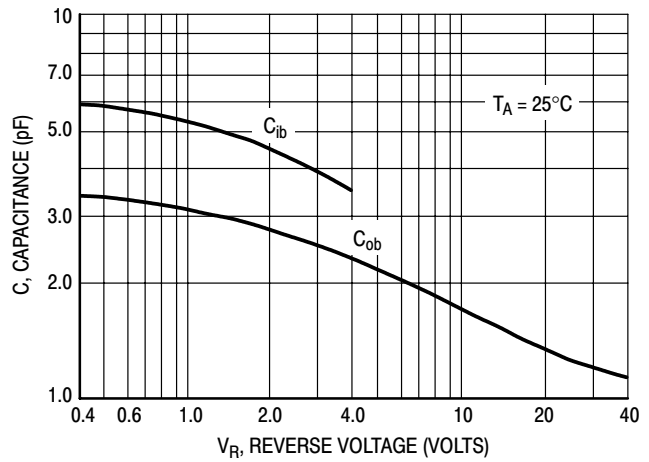

Figure 5. Capacitance

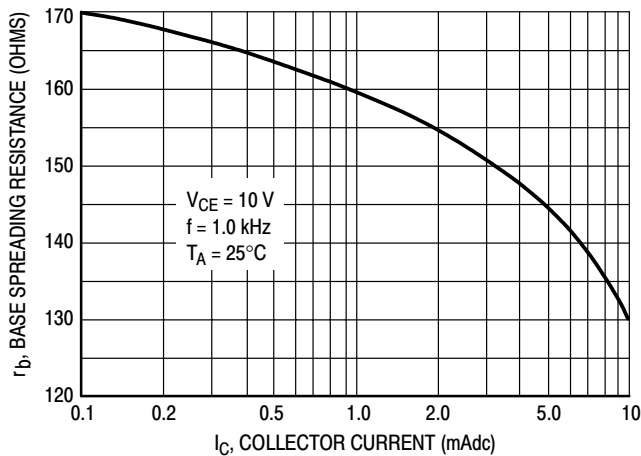
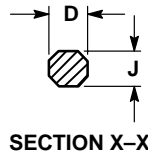
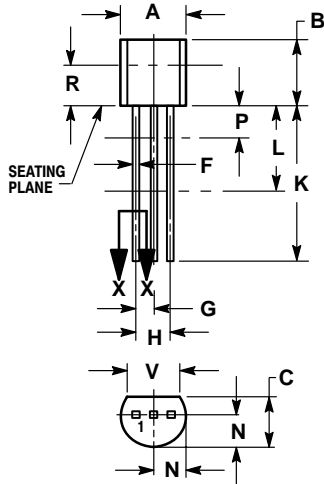

Figure 6. Base Spreading Resistance

BC549B,C BC550B,C

PACKAGE DIMENSIONS

CASE 029-04 (TO-226AA) ISSUE AD



NOTES:

1. DIMENSIONING AND TOLERANCING PER ANSI Y14.5M, 1982.
2. CONTROLLING DIMENSION: INCH.
3. CONTOUR OF PACKAGE BEYOND DIMENSION R IS UNCONTROLLED.
4. DIMENSION F APPLIES BETWEEN P AND L. DIMENSION D AND J APPLY BETWEEN L AND K MINIMUM. LEAD DIMENSION IS UNCONTROLLED IN P AND BEYOND DIMENSION K MINIMUM.

DIM	INCHES		MILLIMETERS	
	MIN	MAX	MIN	MAX
A	0.175	0.205	4.45	5.20
B	0.170	0.210	4.32	5.33
C	0.125	0.165	3.18	4.19
D	0.016	0.022	0.41	0.55
F	0.016	0.019	0.41	0.48
G	0.045	0.055	1.15	1.39
H	0.095	0.105	2.42	2.66
J	0.015	0.020	0.39	0.50
K	0.500	---	12.70	---
L	0.250	---	6.35	---
N	0.080	0.105	2.04	2.66
P	---	0.100	---	2.54
R	0.115	---	2.93	---
V	0.135	---	3.43	---

STYLE 17:

1. COLLECTOR
2. BASE
3. EMITTER

ON Semiconductor and  are trademarks of Semiconductor Components Industries, LLC (SCILLC). SCILLC reserves the right to make changes without further notice to any products herein. SCILLC makes no warranty, representation or guarantee regarding the suitability of its products for any particular purpose, nor does SCILLC assume any liability arising out of the application or use of any product or circuit, and specifically disclaims any and all liability, including without limitation special, consequential or incidental damages. "Typical" parameters which may be provided in SCILLC data sheets and/or specifications can and do vary in different applications and actual performance may vary over time. All operating parameters, including "Typicals" must be validated for each customer application by customer's technical experts. SCILLC does not convey any license under its patent rights nor the rights of others. SCILLC products are not designed, intended, or authorized for use as components in systems intended for surgical implant into the body, or other applications intended to support or sustain life, or for any other application in which the failure of the SCILLC product could create a situation where personal injury or death may occur. Should Buyer purchase or use SCILLC products for any such unintended or unauthorized application, Buyer shall indemnify and hold SCILLC and its officers, employees, subsidiaries, affiliates, and distributors harmless against all claims, costs, damages, and expenses, and reasonable attorney fees arising out of, directly or indirectly, any claim of personal injury or death associated with such unintended or unauthorized use, even if such claim alleges that SCILLC was negligent regarding the design or manufacture of the part. SCILLC is an Equal Opportunity/Affirmative Action Employer.

PUBLICATION ORDERING INFORMATION

NORTH AMERICA Literature Fulfillment:

Literature Distribution Center for ON Semiconductor
P.O. Box 5163, Denver, Colorado 80217 USA
Phone: 303-675-2175 or 800-344-3860 Toll Free USA/Canada
Fax: 303-675-2176 or 800-344-3867 Toll Free USA/Canada
Email: ONlit@hibbertco.com
Fax Response Line: 303-675-2167 or 800-344-3810 Toll Free USA/Canada

N. American Technical Support: 800-282-9855 Toll Free USA/Canada

EUROPE: LDC for ON Semiconductor – European Support

German Phone: (+1) 303-308-7140 (Mon-Fri 2:30pm to 7:00pm CET)
Email: ONlit-german@hibbertco.com
French Phone: (+1) 303-308-7141 (Mon-Fri 2:00pm to 7:00pm CET)
Email: ONlit-french@hibbertco.com
English Phone: (+1) 303-308-7142 (Mon-Fri 12:00pm to 5:00pm GMT)
Email: ONlit@hibbertco.com

EUROPEAN TOLL-FREE ACCESS*: 00-800-4422-3781

*Available from Germany, France, Italy, UK, Ireland

CENTRAL/SOUTH AMERICA:

Spanish Phone: 303-308-7143 (Mon-Fri 8:00am to 5:00pm MST)
Email: ONlit-spanish@hibbertco.com
Toll-Free from Mexico: Dial 01-800-288-2872 for Access –
then Dial 866-297-9322

ASIA/PACIFIC: LDC for ON Semiconductor – Asia Support

Phone: 303-675-2121 (Tue-Fri 9:00am to 1:00pm, Hong Kong Time)
Toll Free from Hong Kong & Singapore:
001-800-4422-3781
Email: ONlit-asia@hibbertco.com

JAPAN: ON Semiconductor, Japan Customer Focus Center

4-32-1 Nishi-Gotanda, Shinagawa-ku, Tokyo, Japan 141-0031
Phone: 81-3-5740-2700
Email: r14525@onsemi.com

ON Semiconductor Website: <http://onsemi.com>

For additional information, please contact your local Sales Representative.